

# 1.575 GHz GPS Ceramic Chip Antenna

Ground cleared under antenna, clearance area 4.00 x 4.25 mm / 6.25 mm. Pulse Part Number: W3011 / W3011A



## Features

- Omni directional radiation
- Low profile
- Compact size W x L x H (3.2 x 1.6 x 1.1 mm)
- Low weight (33 mg)
- Lead free materials
- Fully SMD compatible
- Lead free soldering compatible
- Tape-and-reel packing
- RoHS Compliant Product

## Applications

- GPS L1 band
- 1.575 GHz

## Electrical specifications @ +25 °C

*Note: Electrical characteristics depend on test board (GP) size and antenna positioning on GP and the size of the ground clearance area.*

### 1.575 GHz GPS W3011

Typical performance (Test board size 80 x 37 mm, PWB ground clearance area 4.00 x 4.25 mm)

Frequency Range [MHz]	RHCP Gain [dBic]	Max Gain [dBi]	Efficiency [%] / [dB]	Return loss min. [dB]	Impedance [ $\Omega$ ]	Operating Temperature [°C]
1575.42 +/-10	0.85 (Peak) 0.5 (Band edges)	3.4 (Peak) 3.0 (Band edges)	85 / -0.7 (Peak) 80 / -1.0 (Band edges)	-12	50	-40 to +85

### 1.575 GHz GPS W3011A

Typical performance (Test board size 80 x 37 mm, PWB ground clearance area 4.00 x 6.25 mm)

Frequency Range [MHz]	RHCP Gain [dBic]	Max Gain [dBi]	Efficiency [%] / [dB]	Return loss min. [dB]	Impedance [ $\Omega$ ]	Operating Temperature [°C]
1575.42 +/-10	1.0 (Peak) 0.7 (Band edges)	3.7 (Peak) 3.4 (Band edges)	85 / -0.7 (Peak) 85 / -1.0 (Band edges)	-16	50	-40 to +85

#### Pulse Finland Oy

Takatie 6  
90440 Kempele, Finland  
Tel: +358 207 935 500  
Fax: +358 207 935 501  
[www.pulseeng.com/antennas](http://www.pulseeng.com/antennas)



© 2008. All Rights Reserved.

# 1.575 GHz GPS Ceramic Chip Antenna

Ground cleared under antenna, clearance area 4.00 x 4.25 mm. Pulse Part Number: W3011

## Terminal Configuration

### PWB Layout

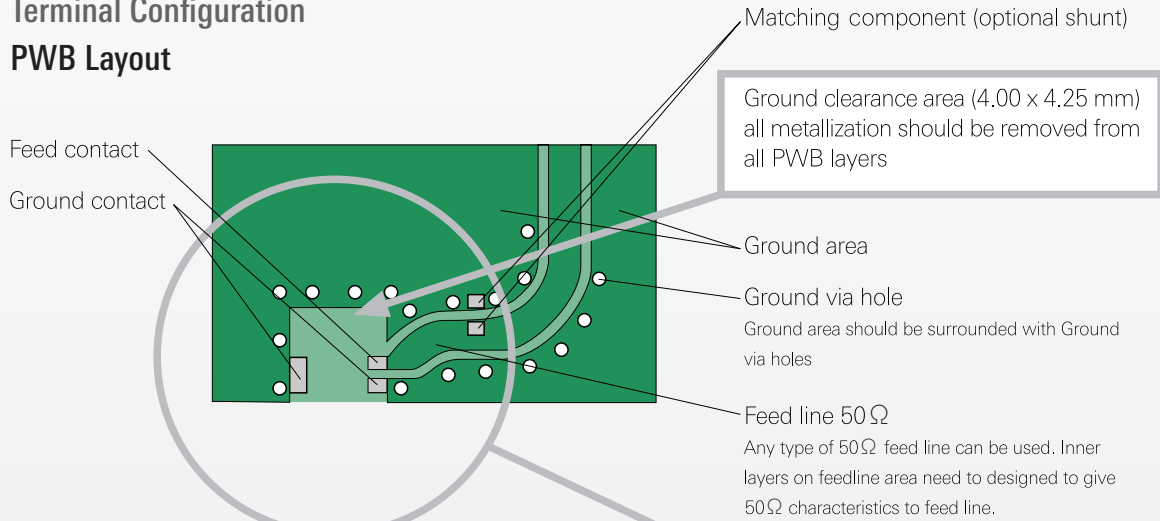

## Antenna

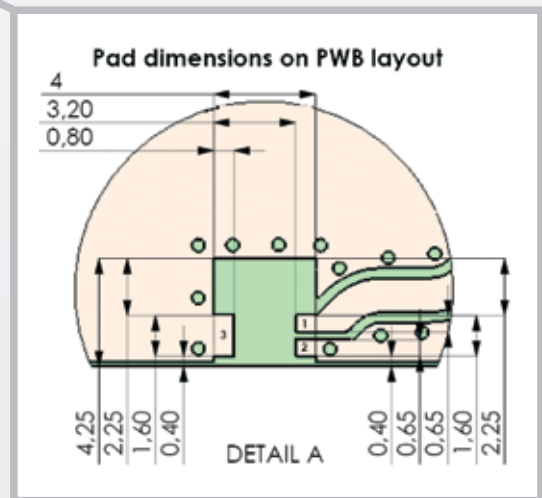
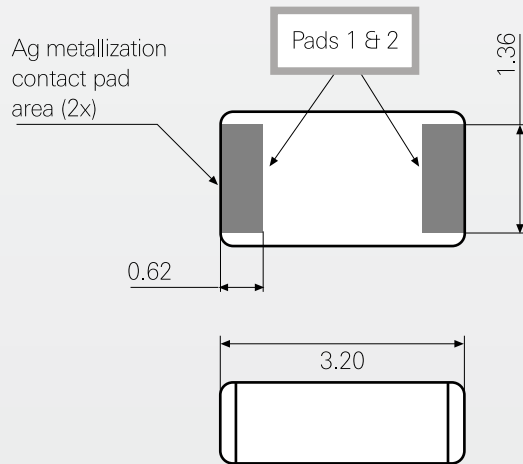

## Antenna features

No.	Terminal name	Terminal Dimensions
1	Feed / GND	0.62 x 1.36 mm
2	Feed / GND	0.62 x 1.36 mm

Antenna is symmetrical.  
Either of terminals 1 or 2 can be feed / GND

## PWB features

No.	Terminal name	Terminal Dimensions
1	Feed	0.8 x 0.65 mm
2	GND	0.8 x 0.65 mm
3	GND	0.8 x 1.60 mm

## Pulse Finland Oy

Takatie 6  
90440 Kempele, Finland  
Tel: +358 207 935 500  
Fax: +358 207 935 501  
[www.pulseeng.com/antennas](http://www.pulseeng.com/antennas)



# 1.575 GHz GPS Ceramic Chip Antenna

Ground cleared under antenna, clearance area 4.00 x 6.25 mm. Pulse Part Number: W3011a

## Terminal Configuration

### PWB Layout

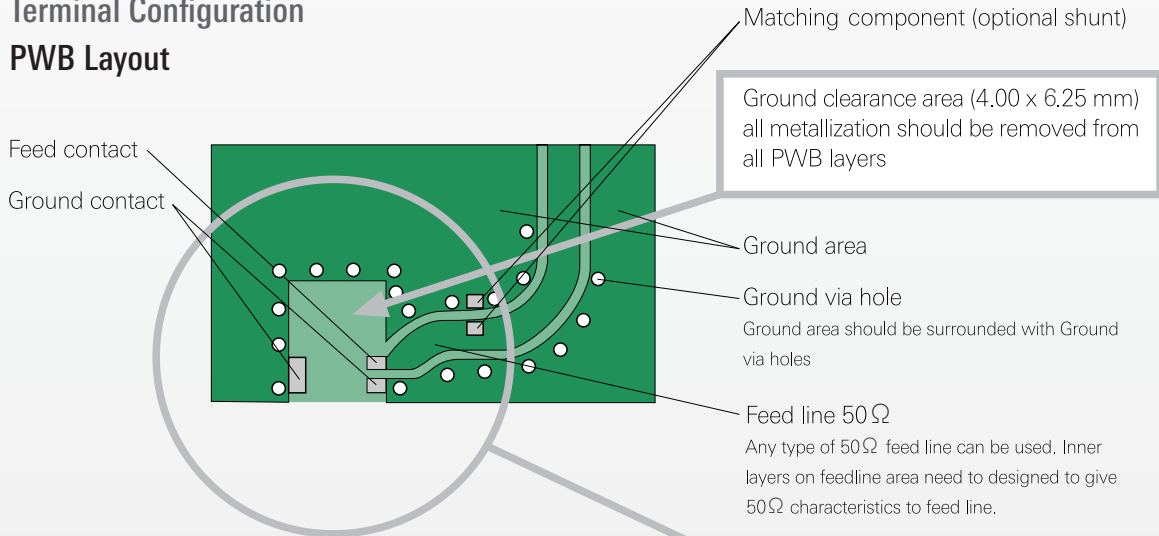

## Antenna

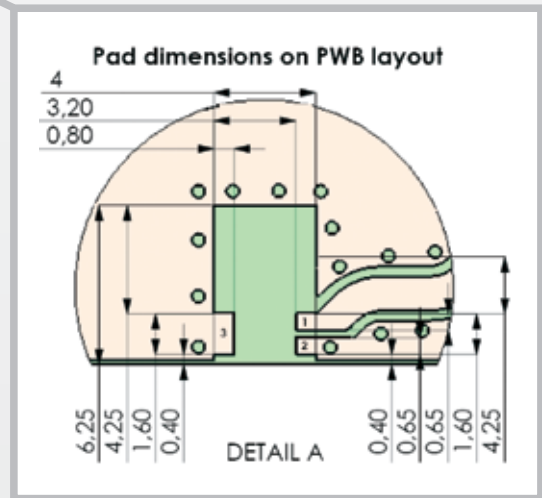
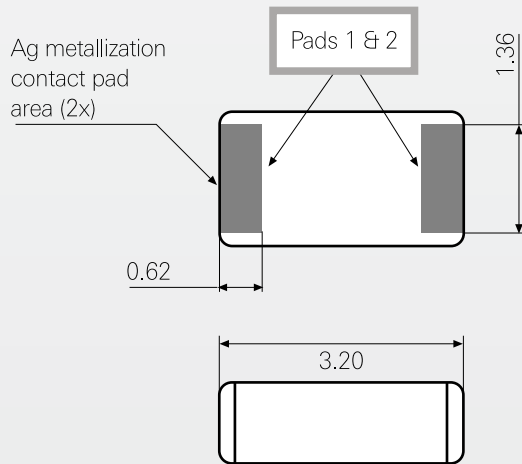

## Antenna features

No.	Terminal name	Terminal Dimensions
1	Feed / GND	0.62 x 1.36 mm
2	Feed / GND	0.62 x 1.36 mm

Antenna is symmetrical.

Either of terminals 1 or 2 can be feed / GND

## PWB features

No.	Terminal name	Terminal Dimensions
1	Feed	0.8 x 0.65 mm
2	GND	0.8 x 0.65 mm
3	GND	0.8 x 1.60 mm

## Pulse Finland Oy

Takatie 6  
90440 Kempele, Finland  
Tel: +358 207 935 500  
Fax: +358 207 935 501  
[www.pulseeng.com/antennas](http://www.pulseeng.com/antennas)



# 1.575 GHz GPS Ceramic Chip Antenna

Ground cleared under antenna, clearance area 4.00 x 4.25 mm / 6.25 mm. Pulse Part Number: W3011 / W3011A

## W3011 GPS Antenna Test Set Up and Measured Performance

Ground cleared under antenna, clearance area 4.00 x 4.25 mm.

### Typical Electrical Characteristics (T=25°C)

Measured on the 80 x 37mm test board without matching circuit and in antenna position 1 on PWB layout.

Typical Return Loss S11/ impedance, free space efficiency and gain.

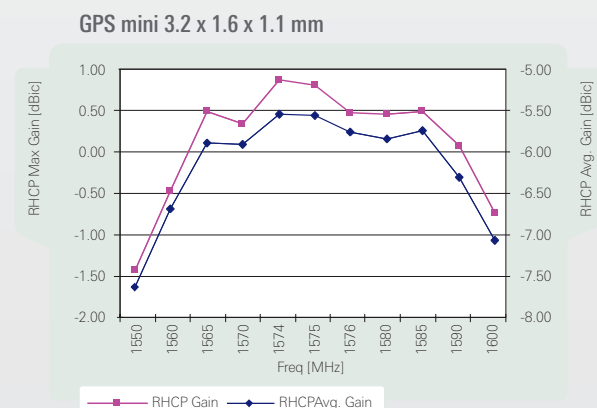
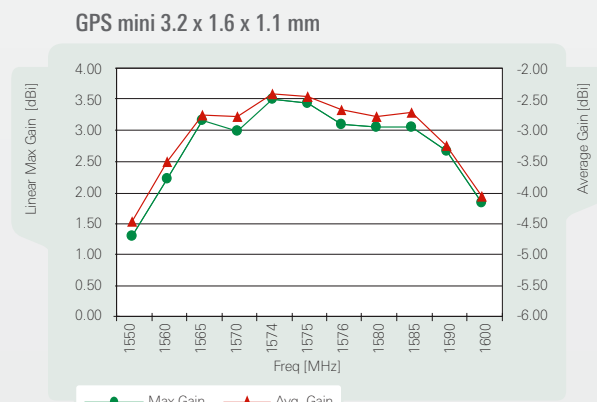
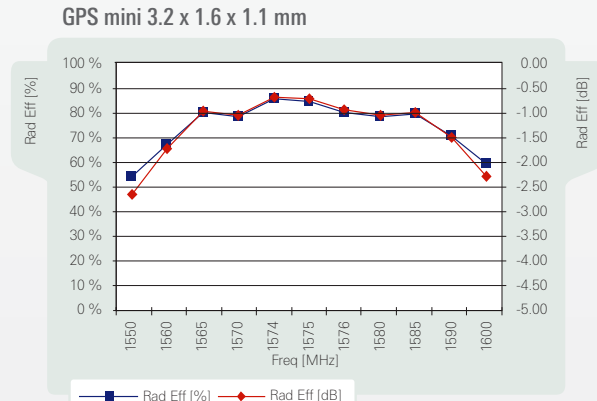
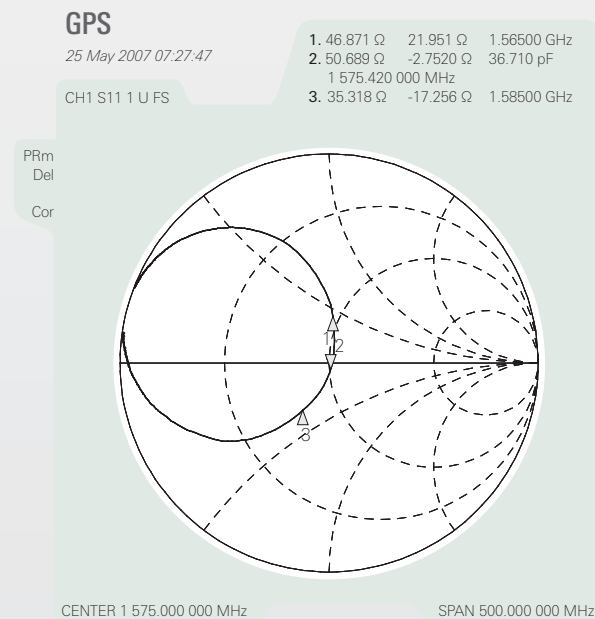
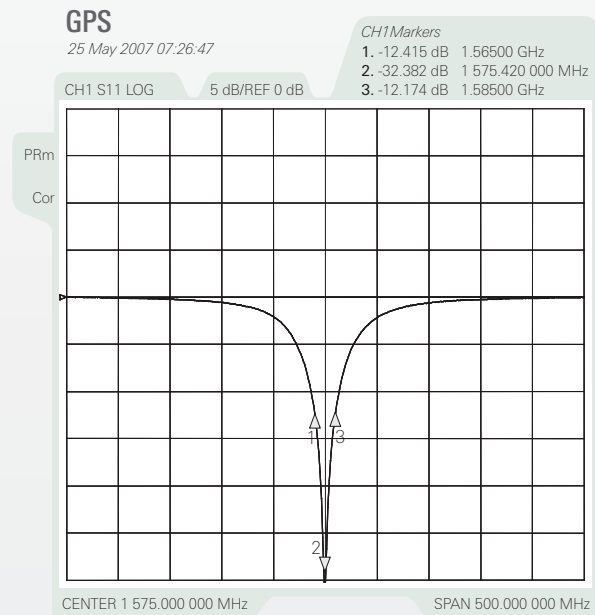

**Pulse Finland Oy**

Takatie 6  
90440 Kempele, Finland  
Tel: +358 207 935 500  
Fax: +358 207 935 501  
[www.pulseeng.com/antennas](http://www.pulseeng.com/antennas)



# 1.575 GHz GPS Ceramic Chip Antenna

Ground cleared under antenna, clearance area 4.00 x 4.25 mm / 6.25 mm. Pulse Part Number: W3011 / W3011A

## 1.575 GHz Typical Radiation Patterns

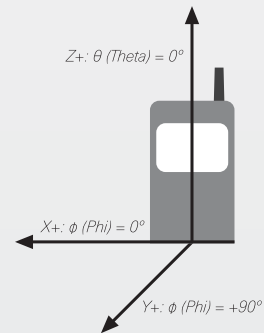
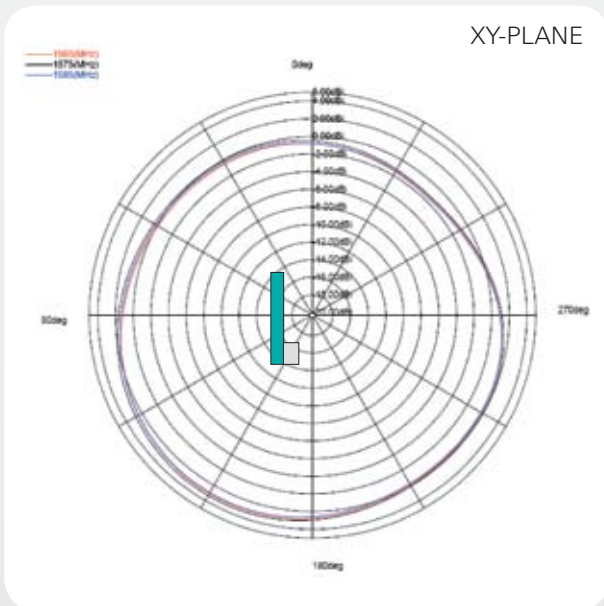
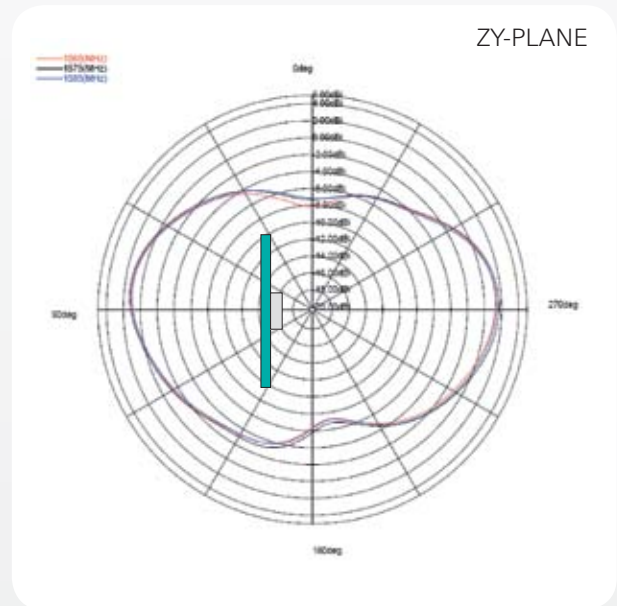
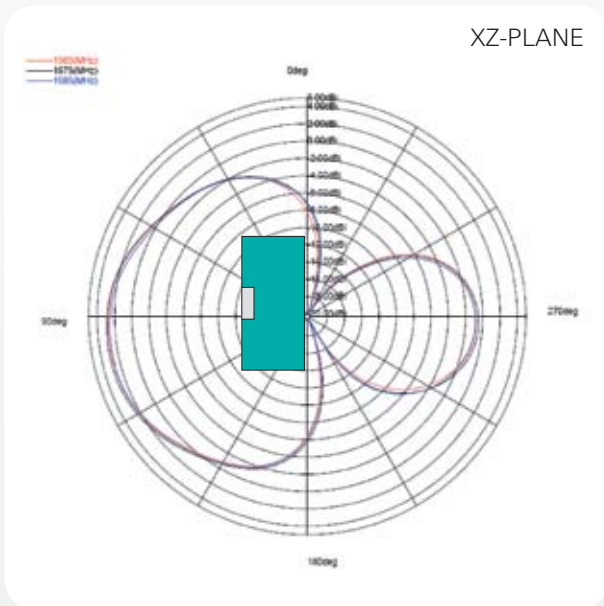

Pulse Finland Oy

Takatie 6  
90440 Kempele, Finland

Tel: +358 207 935 500

Fax: +358 207 935 501

[www.pulseeng.com/antennas](http://www.pulseeng.com/antennas)



© 2008. All Rights Reserved.

# 1.575 GHz GPS Ceramic Chip Antenna

Ground cleared under antenna, clearance area 4.00 x 4.25 mm / 6.25 mm. Pulse Part Number: W3011 / W3011A

## W3011a GPS 1.575GHz Test Set Up and Measured Performance

Ground cleared under antenna, clearance area 4.00 x 6.25 mm

### Typical Electrical Characteristics (T=25°C)

Measured on the 80 x 37mm test board with matching circuit (shunt 1.8 pF) and in antenna position 1 on PWB layout.

Typical Return Loss S11/ impedance, free space efficiency and gain

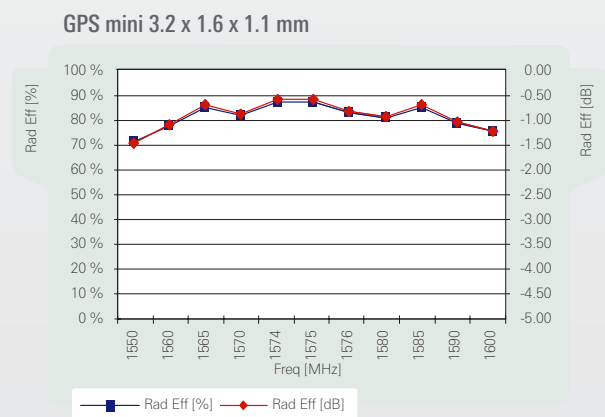
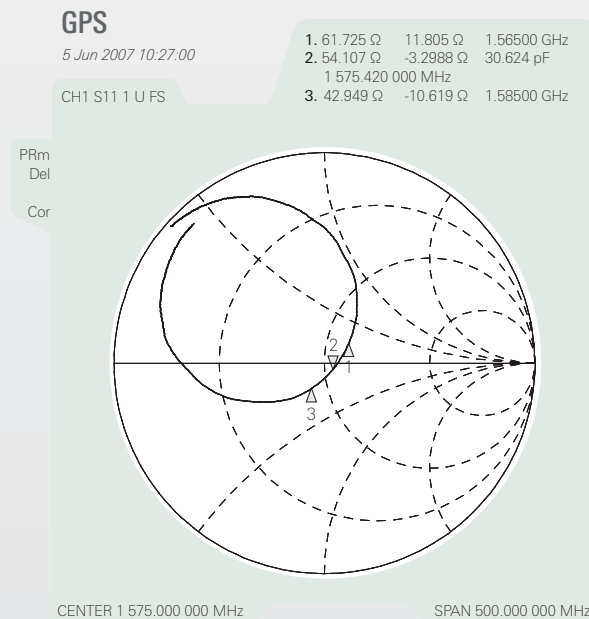
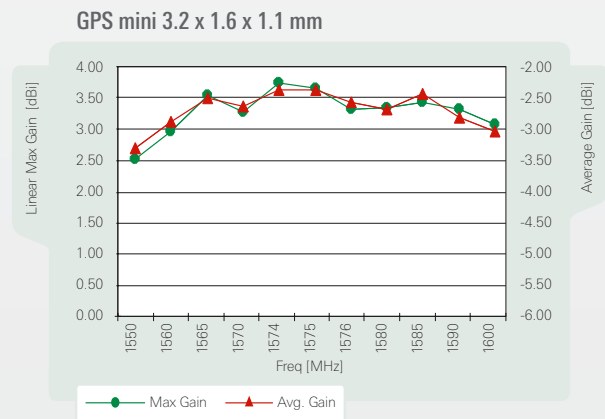
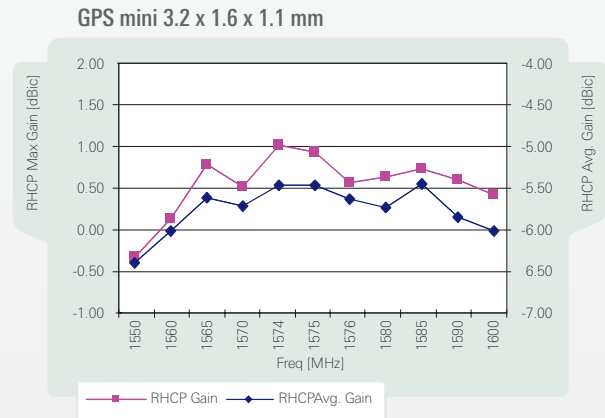
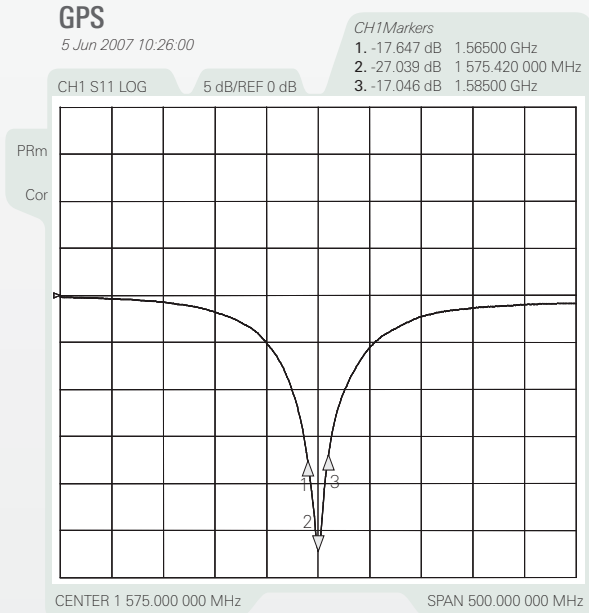

Pulse Finland Oy

Takatie 6  
90440 Kempele, Finland  
Tel: +358 207 935 500  
Fax: +358 207 935 501  
[www.pulseeng.com/antennas](http://www.pulseeng.com/antennas)



# 1.575 GHz GPS Ceramic Chip Antenna

Ground cleared under antenna, clearance area 4.00 x 4.25 mm / 6.25 mm. Pulse Part Number: W3011 / W3011A

## 1.575 GHz Typical Radiation Patterns

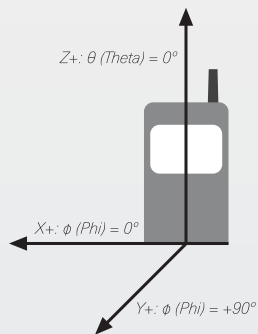
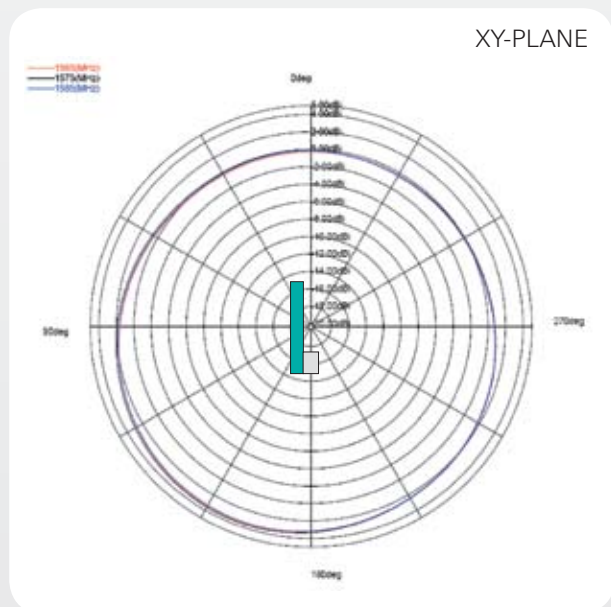
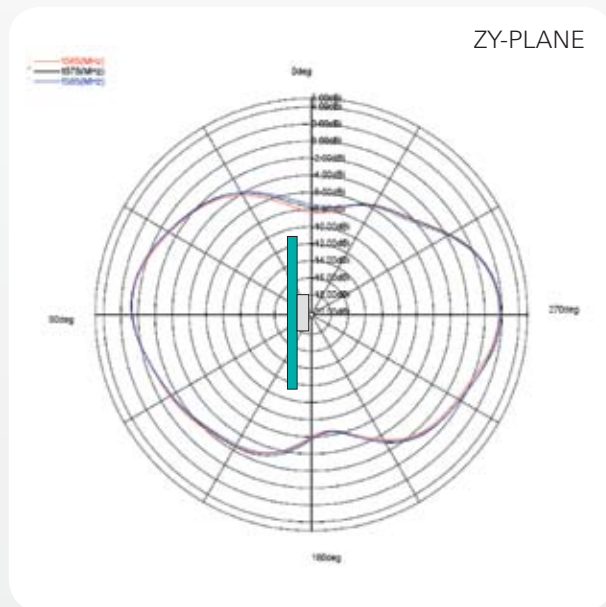
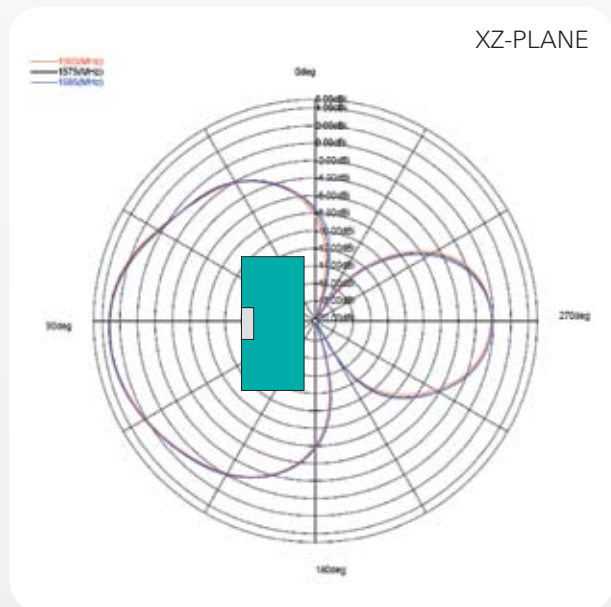

Pulse Finland Oy

Takatie 6  
90440 Kempele, Finland  
Tel: +358 207 935 500  
Fax: +358 207 935 501  
[www.pulseeng.com/antennas](http://www.pulseeng.com/antennas)



© 2008. All Rights Reserved.

# 1.575 GHz GPS Ceramic Chip Antenna

Ground cleared under antenna, clearance area 4.00 x 4.25 mm / 6.25 mm. Pulse Part Number: W3011 / W3011A

## Packing Form

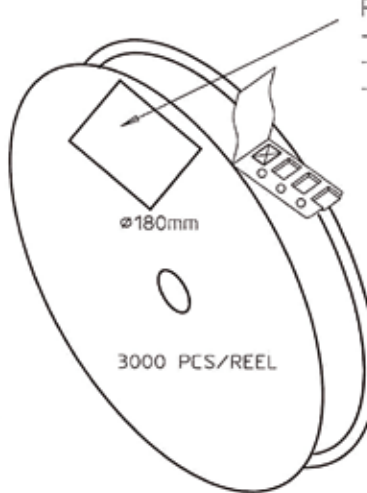
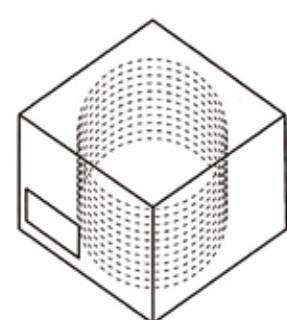
**REEL LABEL INFORMATION:**

- TRACEABILITY
- QUANTITY
- PRODUCT CODE

**CARRIER TAPE H85-00125**  
width=8,00 depth=1,22

**COVER TAPE H85-00126**  
width=5,60

**LENGTH OF TAPE:**

- Leader section: 50 empty cavities before component section
- Trailer section: 25 empty cavities after component section.

Empty part cavities at leader and trailer section of the tape must be sealed with top cover tape.

<b>BOX H85-00128</b> (182x182x132)	1 pcs
- LABEL	1 pcs/BOX
<b>REEL H85-00127</b> (D180, W12)	10 pcs
- REEL LABEL	1 pcs/REEL

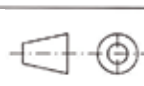
<b>MATERIAL</b>			
<b>HANDLINGS</b>			
	RATIO	DRWN	010305 PeHa H
		DGNER	G
		CHKD	F
		APPRD	E
PRODUCT H90-OY116-F01P01		APPRD BY	D
			C
DENOMINATION PACKING FORM			B
			A
		VERSION	MOD/DATE/NAME

Pulse Finland Oy

Takatie 6  
90440 Kempele, Finland

Tel: +358 207 935 500

Fax: +358 207 935 501

[www.pulseeng.com/antennas](http://www.pulseeng.com/antennas)



© 2008. All Rights Reserved.