



Piezoelectronic buzzers

Without oscillator circuit

Pin terminal/Lead lines/SMD

PS series

Pin terminal type

PS12

PS14

PS17

PS19

Lead wire type

PS15

SMD type

PST14

Piezoelectronic buzzers

Without oscillator circuit

Pin terminal/Lead lines/SMD

Overview of the PS series

FEATURES

- Sounding body(unimorph) that piezo bonded the diaphragm is used, and attach on circuit, and is easy design high performance efficiency piezoelectric buzzer.
- They feature extremely low power consumption in comparison to electromagnetic units.
- Because these buzzers are designed for external excitation, the same part can serve as both a musical tone oscillator and a buzzer.
- They can be used with automated inserters. Moisture-resistant models are also available.
- The lead wire type(PS1550L40N) with both-sided adhesive tape installed easily is prepared.

APPLICATION

Electric ranges, washing machines, computer terminals, various devices that require speech synthesis output.

RECOMMENDED OPERATING CIRCUIT EXAMPLE

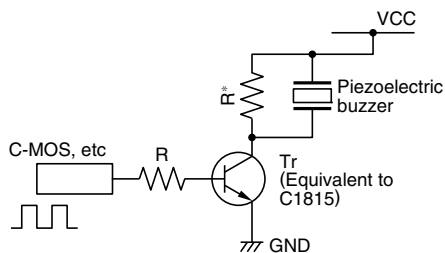

* Resistor to do charging and discharging to a piezoelectric element (Value of about $1k\Omega$ is good efficiency).

SOUND MEASURING METHOD

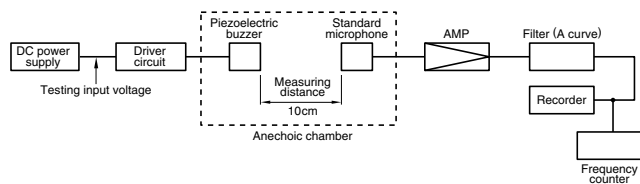











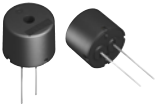

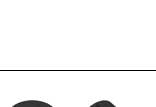

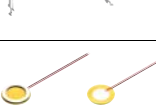
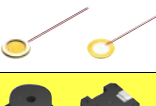

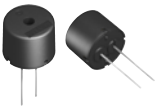

○ RoHS Directive Compliant Product: See the following for more details. <https://product.tdk.com/info/en/environment/rohs/index.html>

 Please be sure to request delivery specifications that provide further details on the features and specifications of the products for proper and safe use. Please note that the contents may change without any prior notice due to reasons such as upgrading.

Overview of the PS series

PRODUCT LINEUP

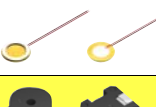
Type	Part No.	Outside dimensions			Characteristics		
		Outside diameter (mm)	Height [excluding terminal] (mm)	Terminal pitch (mm)	Sound pressure (dB(A)/10cm)	Frequency (kHz)	Input voltage (V _{0-P})[rectangular waves]
PS12	 PS1240P02BT	ø12.2	6.5	5	70 min.	4	3
	 PS1240P02CT3	ø12.2	3.5	5	60 min.	4	3
PS14	 PS1440P02BT	ø14	8	5	75 min.	4	3
	 PS1420P02CT	ø14	11	5	70 min.	2	5
PS17	 PS1720P02	ø17	8	10	70 min.	2	3
	 PS1740P02E	ø17	7.5	10	75 min.	4	3
	 PS1740P02CE	ø17	4.6	10	60 min.	4	3
PS19	 PS1927P02	ø19	10.5	20	90 min.	2.7	10
	 PS1920P02	ø19	10.5	20	80 min.	2	10
PS15	 PS1550L40N	ø15	1.6	—	Depend on the installation condition		20V _{0-P} max.
PST14	 PST1423P02	□ 14	(9)	—	84 min.	2.3	24V _{p-p} (±12V _{0-p})

Type	Part No.	Application	Features
PS12	 PS1240P02BT		Compact/automatic mountable/12.7mm pitch radial taping
	 PS1240P02CT3		Thin type/automatic mountable/12.7mm pitch radial taping
PS14	 PS1440P02BT	For warning and alarm sounds of home appliances(air conditioners, refrigerators, fan forced heaters, cordless telephones, etc.)	High sound pressure/automatic mountable/15mm pitch radial taping
	 PS1420P02CT		Low frequency tone/automatic mountable/15mm pitch radial taping
PS17	 PS1720P02		Low frequency tone / High sound pressure
	 PS1740P02E		High sound pressure
	 PS1740P02CE		Thin type
PS19	 PS1927P02	For potted circuit (washing machines, drying machines, hot water supply systems, etc.)	High sound pressure / Water-proof processing element
	 PS1920P02		Low frequency tone / Water-proof processing element
PS15	 PS1550L40N	Digital camera	Thin type / Installation easy
PST14	 PST1423P02	applicable to automobile equipment	SMD / Taping products

Background yellow: The product which is not recommended to a new design.

⚠ Please be sure to request delivery specifications that provide further details on the features and specifications of the products for proper and safe use. Please note that the contents may change without any prior notice due to reasons such as upgrading.

Pin terminal type PS12

PS1240P02BT

FEATURES

- Miniature size($\phi 12.2 \times T6.5$ mm).
- High cost performance.
- Suitable for automatic radial taping machine(12.7mm-pitch).

SHAPE & DIMENSIONS

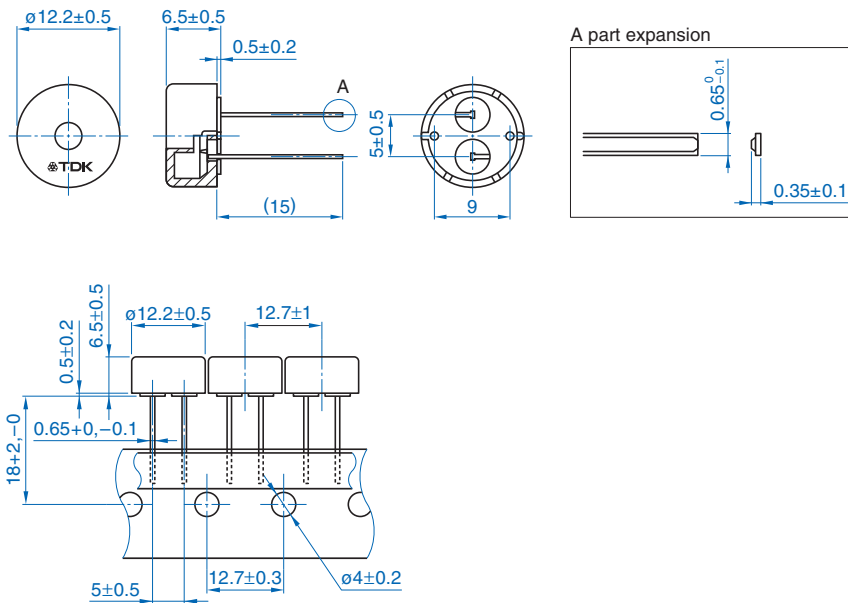

Dimensions in mm

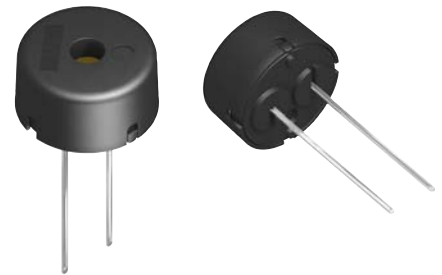

SPECIFICATIONS

Sound pressure	70dB(A)/10cm min.	[at 4kHz, 3V _{0-P} rectangular waves, measuring temperature: 25±5°C, humidity: 60±10%]
Operating temperature range	-10 to +70°C	
Storage conditions	+5 to +40°C, 20 to 70%RH, please use within 6 months	
Maximum input voltage	30V _{0-P} max.	[without DC bias]
Minimum delivery unit	2500 pieces	[500 pieces/1 reel×5 reels]

FREQUENCY SOUND PRESSURE CHARACTERISTICS

SINE WAVE DRIVE

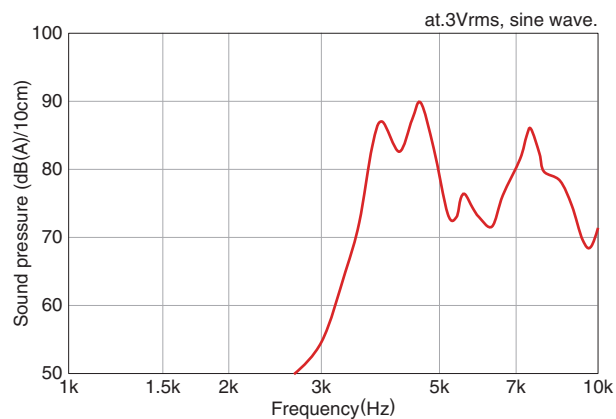

SQUARE WAVE DRIVE

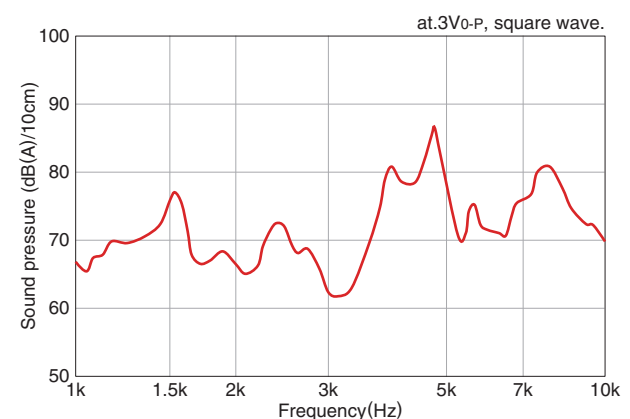

⚠ Please be sure to request delivery specifications that provide further details on the features and specifications of the products for proper and safe use.
Please note that the contents may change without any prior notice due to reasons such as upgrading.

Pin terminal type PS12

PS1240P02CT3

FEATURES

- Thin type($\phi 12.2 \times T3.5$ mm).
- Suitable for automatic radial taping machine(12.7mm-pitch).

SHAPE & DIMENSIONS

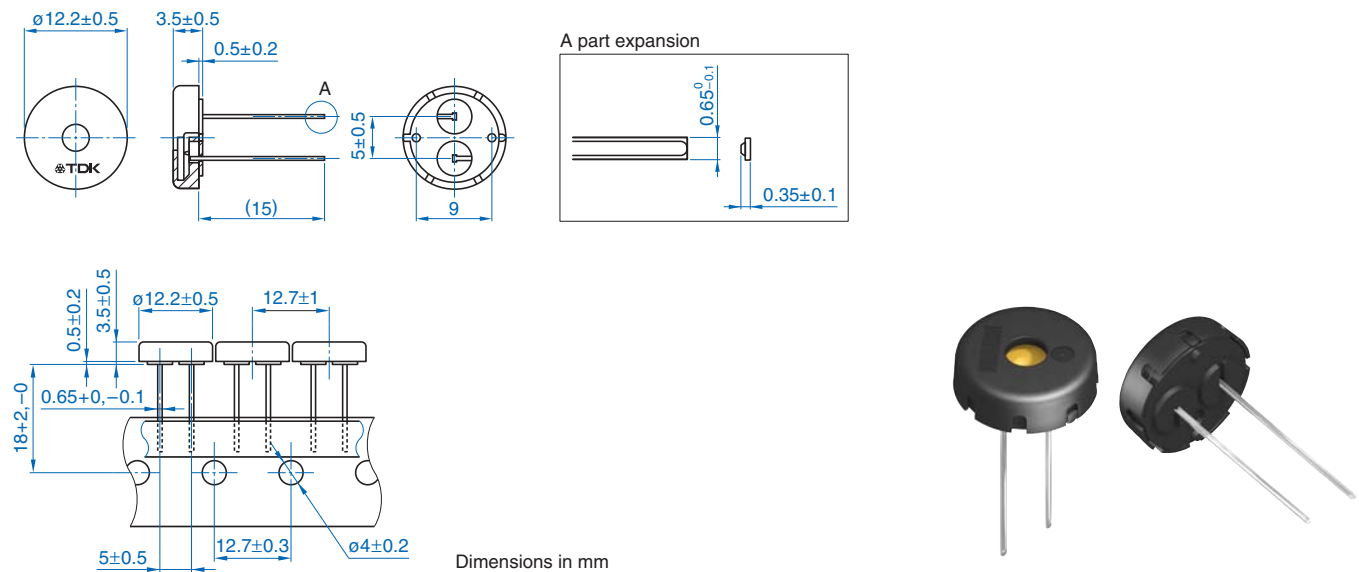

SPECIFICATIONS

Sound pressure	60dB(A)/10cm min.	[at 4kHz, 3V _{0-P} rectangular waves, measuring temperature: 25±5°C, humidity: 60±10%]
Operating temperature range	-10 to +70°C	
Storage conditions	+5 to +40°C, 20 to 70%RH, please use within 6 months	
Maximum input voltage	30V _{0-P} max.	[without DC bias]
Minimum delivery unit	2500個	[500 pieces/1 reel×5 reels]

FREQUENCY SOUND PRESSURE CHARACTERISTICS

SINE WAVE DRIVE

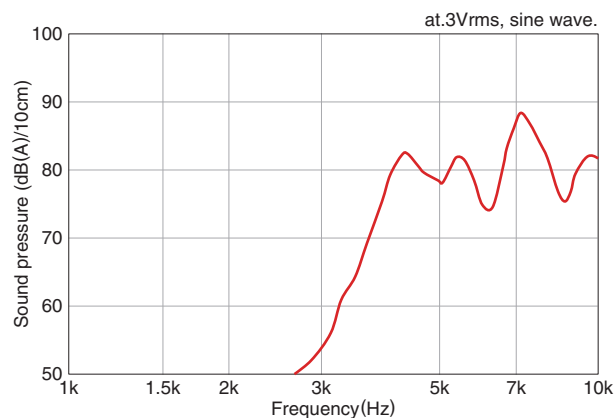

SQUARE WAVE DRIVE

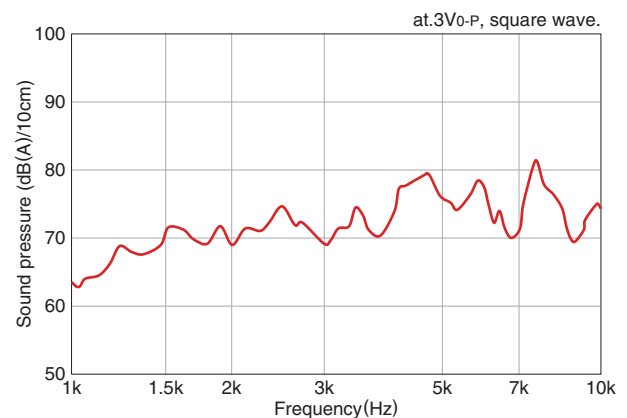

⚠ Please be sure to request delivery specifications that provide further details on the features and specifications of the products for proper and safe use.
Please note that the contents may change without any prior notice due to reasons such as upgrading.

Pin terminal type PS14

PS1440P02BT

FEATURES

- High sound pressure.
- Miniature size($\phi 14 \times T8$ mm).
- Suitable for automatic radial taping machine(15mm-pitch).

SHAPE & DIMENSIONS

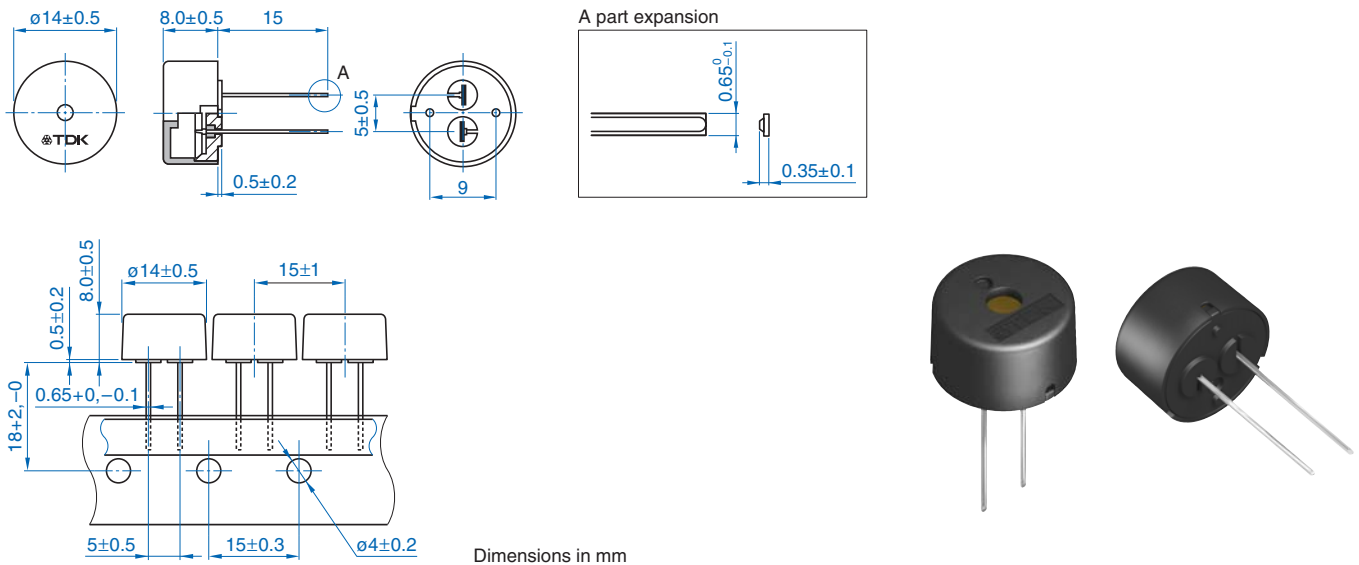

SPECIFICATIONS

Sound pressure	75dB(A)/10cm min.	[at 4kHz, 3V _{0-P} rectangular waves, measuring temperature:25±5°C, humidity:60±10%]
Operating temperature range	-10 to +70°C	
Storage conditions	+5 to +40°C, 20 to 70%RH, please use within 6 months	
Maximum input voltage	30V _{0-P} max.	[without DC bias]
Minimum delivery unit	1750 pieces	[350 pieces/1 reel×5 reels]

FREQUENCY SOUND PRESSURE CHARACTERISTICS

SINE WAVE DRIVE

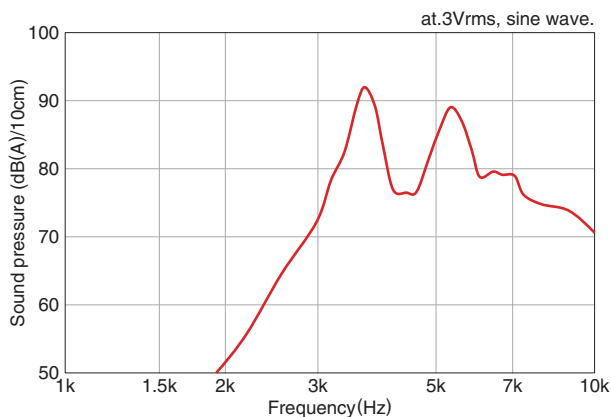

SQUARE WAVE DRIVE

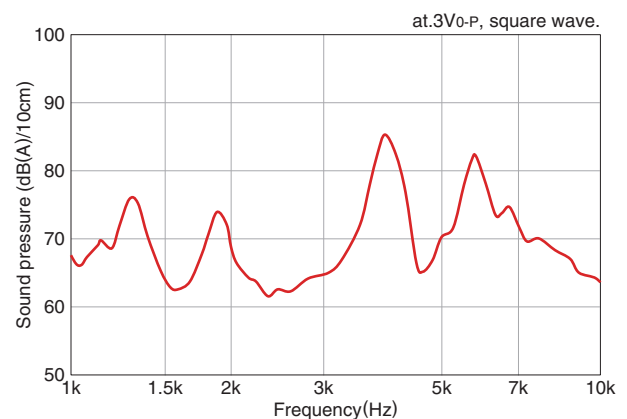

⚠ Please be sure to request delivery specifications that provide further details on the features and specifications of the products for proper and safe use.
Please note that the contents may change without any prior notice due to reasons such as upgrading.

Pin terminal type PS14

PS1420P02CT

FEATURES

- Low frequency tone(2kHz).
- Suitable for automatic radial taping machine(15mm-pitch).

SHAPE & DIMENSIONS

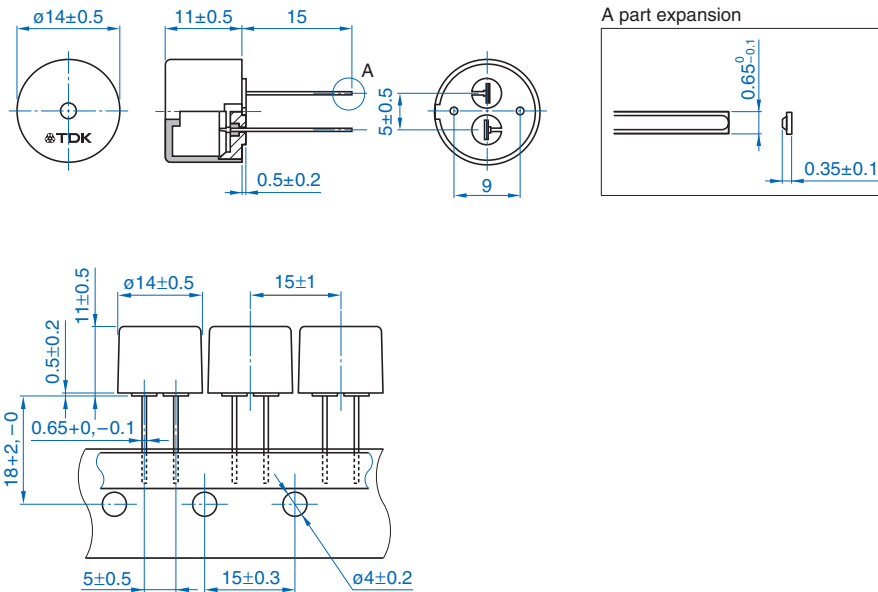

Dimensions in mm

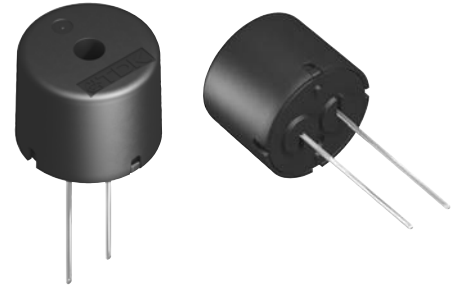

SPECIFICATIONS

Sound pressure	70dB(A)/10cm min.	[at 2kHz, 5V _{0-P} rectangular waves, measuring temperature:25±5°C, humidity:60±10%]
Operating temperature range	-10 to +70°C	
Storage conditions	+5 to +40°C, 20 to 70%RH, please use within 6 months	
Maximum input voltage	30V _{0-P} max.	[without DC bias]
Minimum delivery unit	1750 pieces	[350 pieces/1 reel×5 reels]

FREQUENCY SOUND PRESSURE CHARACTERISTICS

SINE WAVE DRIVE

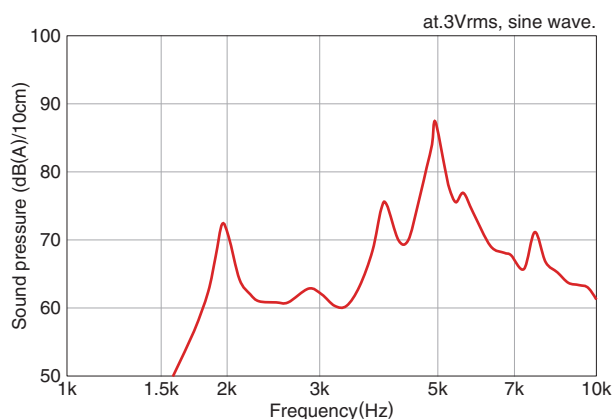

SQUARE WAVE DRIVE

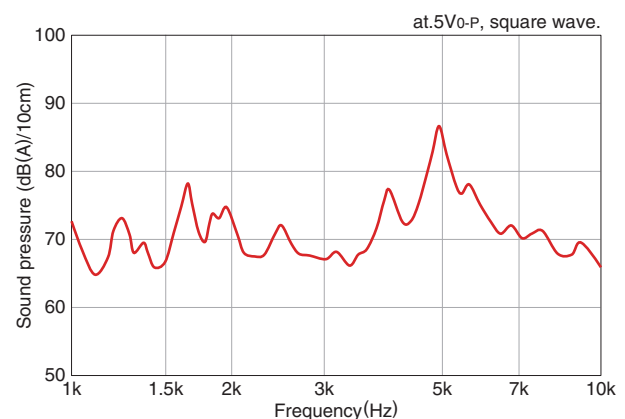

⚠ Please be sure to request delivery specifications that provide further details on the features and specifications of the products for proper and safe use.
Please note that the contents may change without any prior notice due to reasons such as upgrading.

Pin terminal type PS17

PS1720P02

FEATURES

- Low frequency tone.
- High sound pressure.

SHAPE & DIMENSIONS

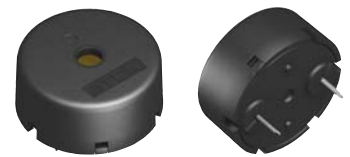
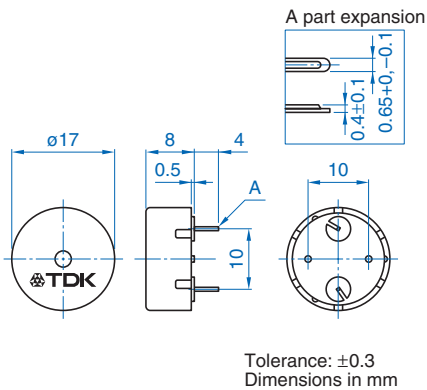

SPECIFICATIONS

Sound pressure	70dB(A)/10cm min.	[at 2kHz, 3V _{0-P} rectangular waves, measuring temperature:25±5°C, humidity:60±10%]
Operating temperature range	-10 to +70°C	
Storage conditions	+5 to +40°C, 20 to 70%RH, please use within 6 months	
Maximum input voltage	30V _{0-P} max.	[without DC bias]
Minimum delivery unit	1500 pieces	

FREQUENCY SOUND PRESSURE CHARACTERISTICS

SINE WAVE DRIVE

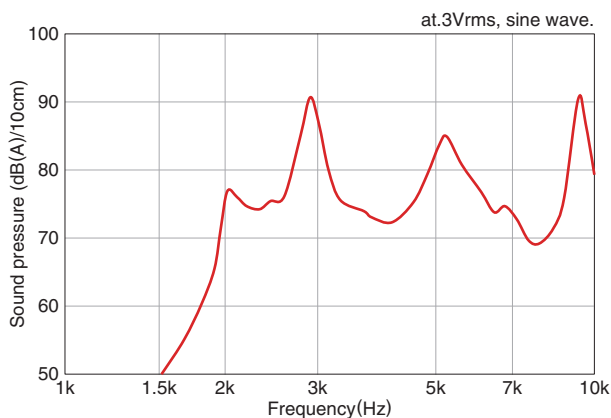

SQUARE WAVE DRIVE

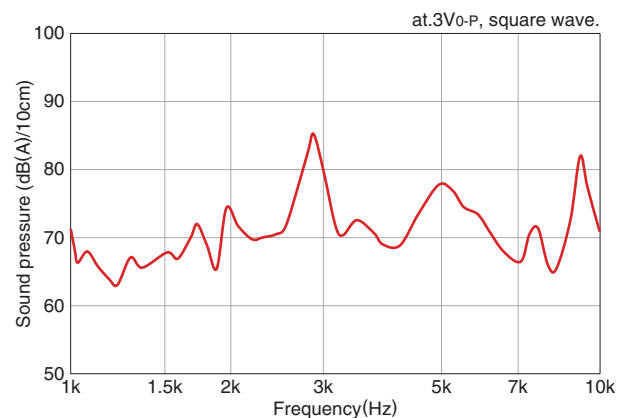

⚠ Please be sure to request delivery specifications that provide further details on the features and specifications of the products for proper and safe use.
Please note that the contents may change without any prior notice due to reasons such as upgrading.

Pin terminal type PS17

PS1740P02E

FEATURES

- High sound pressure.

SHAPE & DIMENSIONS

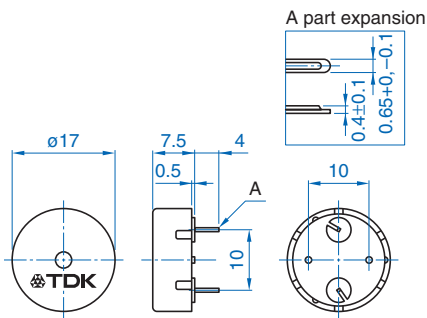

Tolerance: ± 0.3
Dimensions in mm

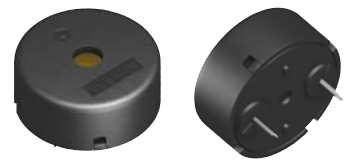

SPECIFICATIONS

Sound pressure	75dB(A)/10cm min.	[at 4kHz, 3V _{0-P} rectangular waves, measuring temperature:25±5°C, humidity:60±10%]
Operating temperature range	-10 to +70°C	
Storage conditions	+5 to +40°C, 20 to 70%RH, please use within 6 months	
Maximum input voltage	30V _{0-P} max.	[without DC bias]
Minimum delivery unit	1500 pieces	

FREQUENCY SOUND PRESSURE CHARACTERISTICS

□ SINE WAVE DRIVE

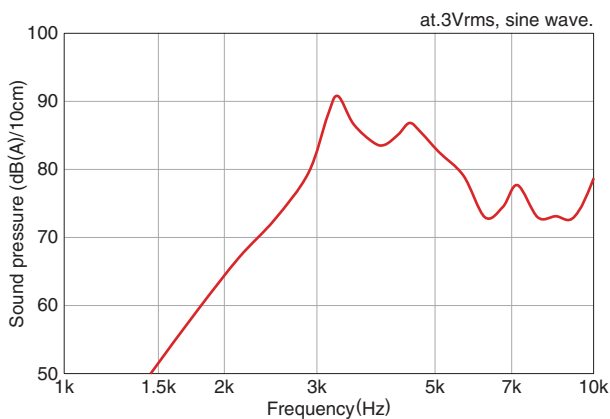

□ SQUARE WAVE DRIVE

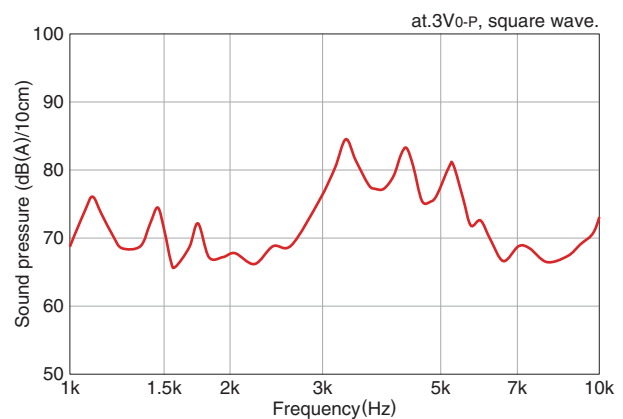

⚠ Please be sure to request delivery specifications that provide further details on the features and specifications of the products for proper and safe use.
Please note that the contents may change without any prior notice due to reasons such as upgrading.

Pin terminal type PS17

PS1740P02CE

FEATURES

- Thin type.

SHAPE & DIMENSIONS

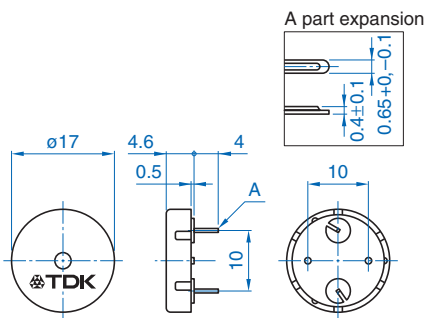

Tolerance: ± 0.3
Dimensions in mm

SPECIFICATIONS

Sound pressure	60dB(A)/10cm min.	[at 4kHz, 3V _{0-P} rectangular waves, measuring temperature:25 \pm 5°C, humidity:60 \pm 10%]
Operating temperature range	-10 to +70°C	
Storage conditions	+5 to +40°C, 20 to 70%RH, please use within 6 months	
Maximum input voltage	30V _{0-P} max.	[without DC bias]
Minimum delivery unit	1500 pieces	

FREQUENCY SOUND PRESSURE CHARACTERISTICS

SINE WAVE DRIVE

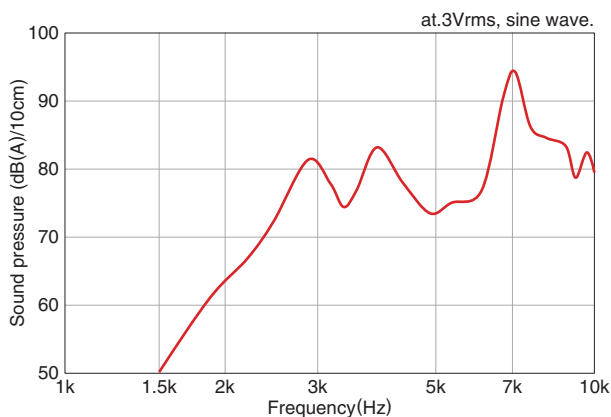

SQUARE WAVE DRIVE

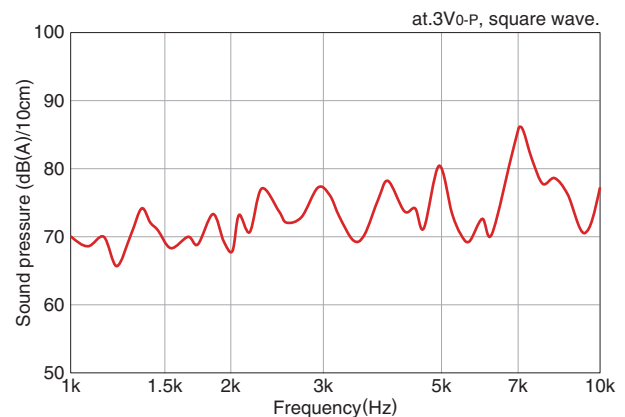

⚠ Please be sure to request delivery specifications that provide further details on the features and specifications of the products for proper and safe use.
Please note that the contents may change without any prior notice due to reasons such as upgrading.

Pin terminal type PS19

PS1920P02

FEATURES

- Low frequency tone(2kHz).
- Piezo element is coated with water proof processing.

SHAPE & DIMENSIONS

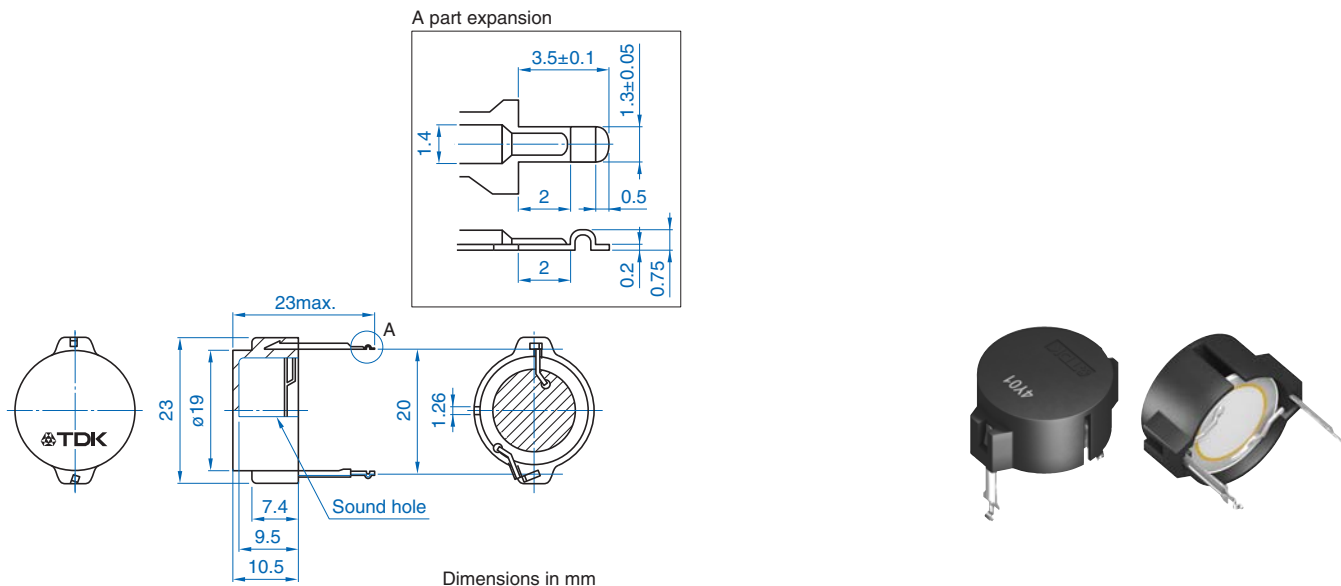

SPECIFICATIONS

Sound pressure	80dB(A)/10cm min. [at 2kHz, 10V _{0-P} rectangular waves, measuring temperature:25±5°C, humidity:60±10%]
Operating temperature range	-10 to +70°C
Storage conditions	+5 to +40°C, 20 to 70%RH, please use within 6 months
Maximum input voltage	20V _{0-P} max. [without DC bias]
Minimum delivery unit	600 pieces

FREQUENCY SOUND PRESSURE CHARACTERISTICS

SINE WAVE DRIVE

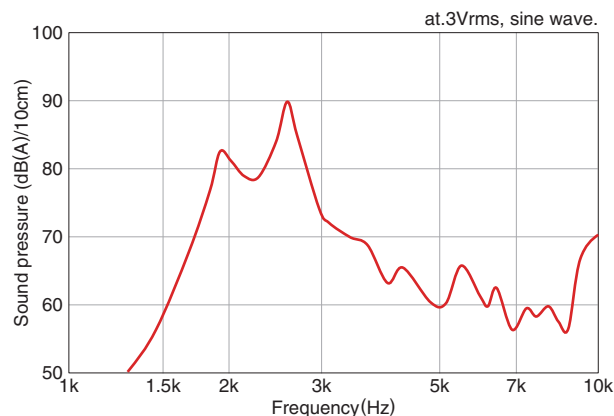

SQUARE WAVE DRIVE

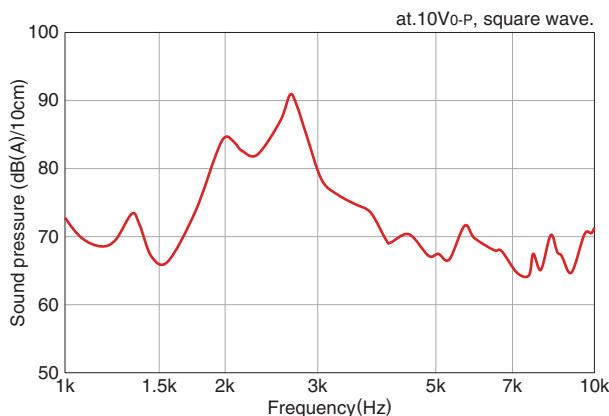

⚠ Please be sure to request delivery specifications that provide further details on the features and specifications of the products for proper and safe use. Please note that the contents may change without any prior notice due to reasons such as upgrading.

Pin terminal type PS19

PS1927P02

FEATURES

- High sound pressure.
- Piezo element is coated with water proof processing.

SHAPE & DIMENSIONS

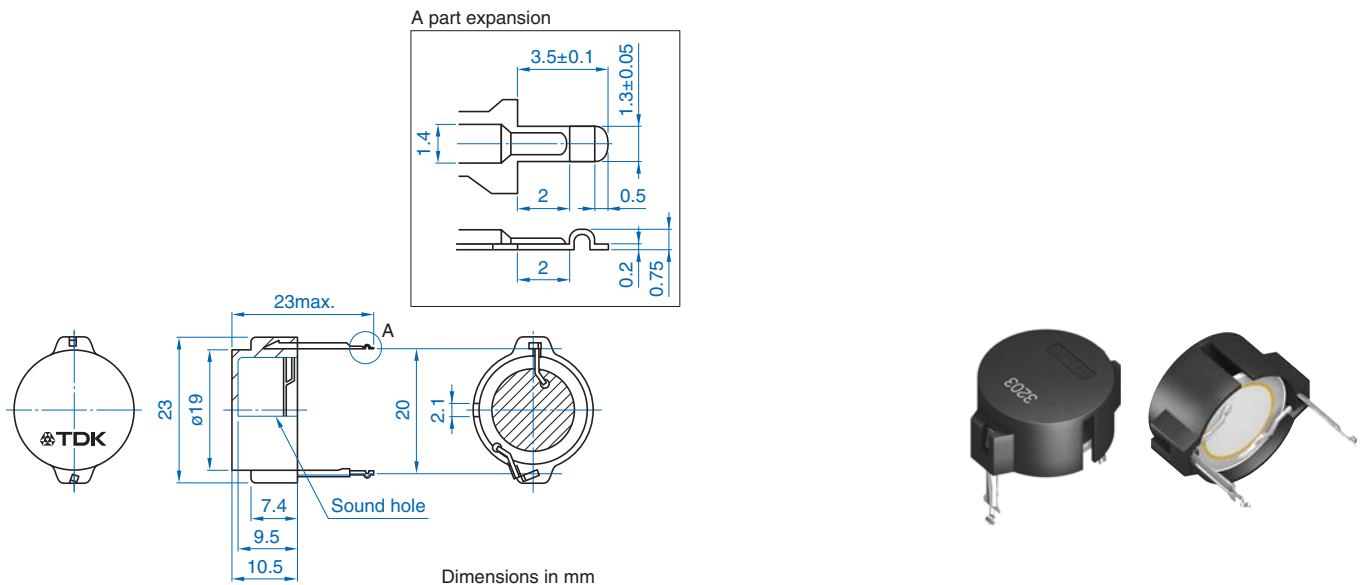

SPECIFICATIONS

Sound pressure	90dB(A)/10cm min. [at 2.7kHz, 10V _{0-P} rectangular waves, measuring temperature:25±5°C, humidity:60±10%]
Operating temperature range	-10 to +70°C
Storage conditions	+5 to +40°C, 20 to 70%RH, please use within 6 months
Maximum input voltage	20V _{0-P} max. [without DC bias]
Minimum delivery unit	600 pieces

FREQUENCY SOUND PRESSURE CHARACTERISTICS

SINE WAVE DRIVE

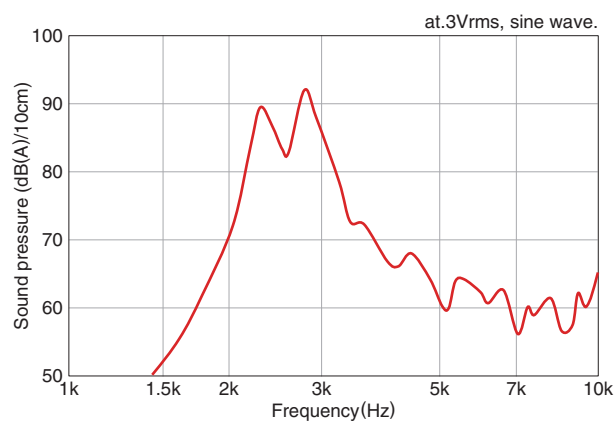

SQUARE WAVE DRIVE

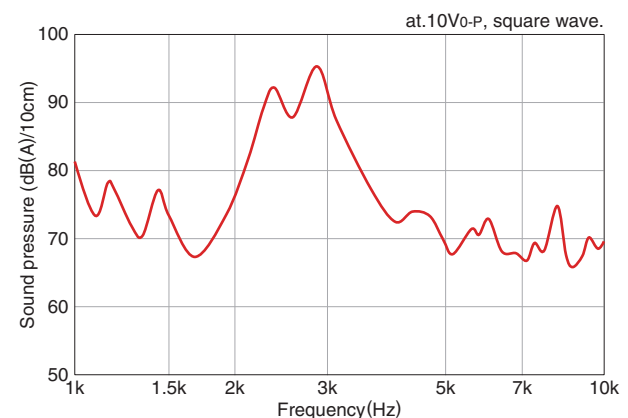

⚠ Please be sure to request delivery specifications that provide further details on the features and specifications of the products for proper and safe use.
Please note that the contents may change without any prior notice due to reasons such as upgrading.

Lead wire type PS15

PS1550L40N

FEATURES

- Miniature size($\phi 15 \times T0.95$ mm).
- High cost performance.
- The installation of this type is easy with both-sided tape.
- This product adopts an excellent both-sided adhesive tape in bonding and the sound characteristic.

SHAPE & DIMENSIONS

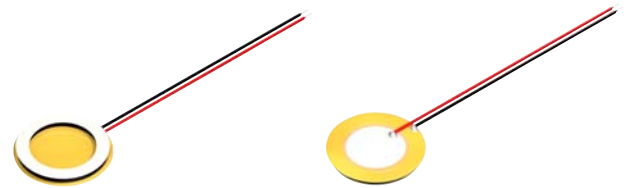
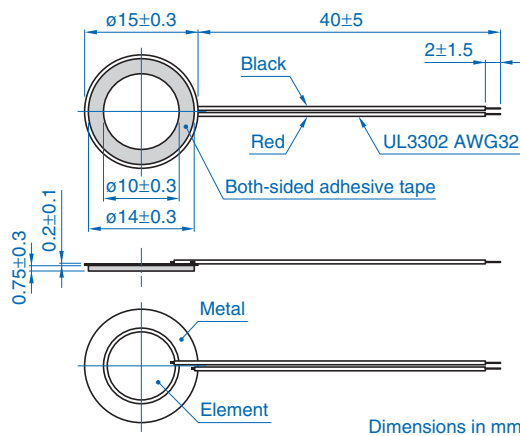

SPECIFICATIONS

Operating temperature range	-10 to +70°C
Storage conditions	+5 to +40°C, 20 to 70%RH, please use within 6 months
Maximum input voltage	20V _{0-P} max. [without DC bias]
Minimum delivery unit	12000 pieces

FREQUENCY SOUND PRESSURE CHARACTERISTICS

SINE WAVE DRIVE

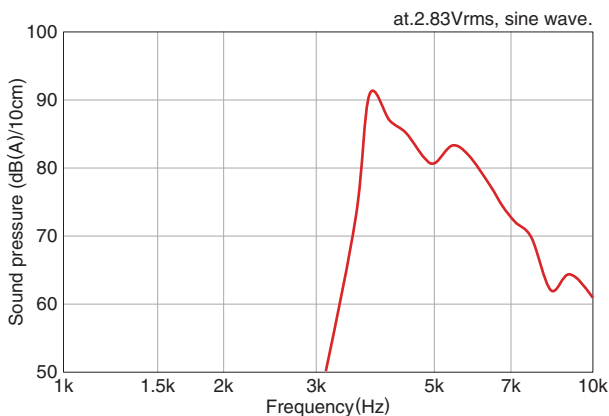

SQUARE WAVE DRIVE

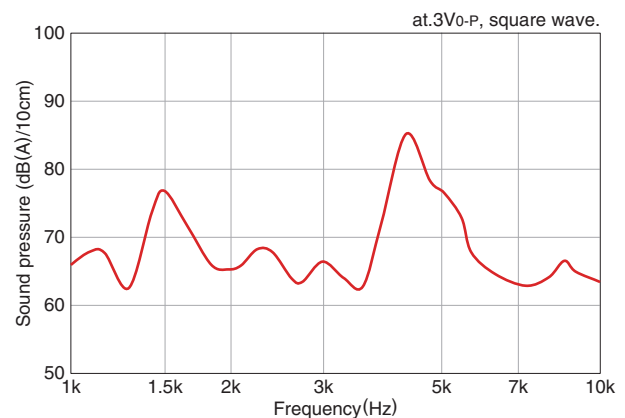

* The frequency characteristic changes depending on the case shape and the installation method.

⚠ Please be sure to request delivery specifications that provide further details on the features and specifications of the products for proper and safe use. Please note that the contents may change without any prior notice due to reasons such as upgrading.

B U Z Z E R S



SMD type PST14

PST1423P02

FEATURES

- These high reliability electromagnetic buzzers are applicable to automobile equipment.
- Suitable for surface mount process(SMD). Stand up to reflow process twice.

SHAPE & DIMENSIONS

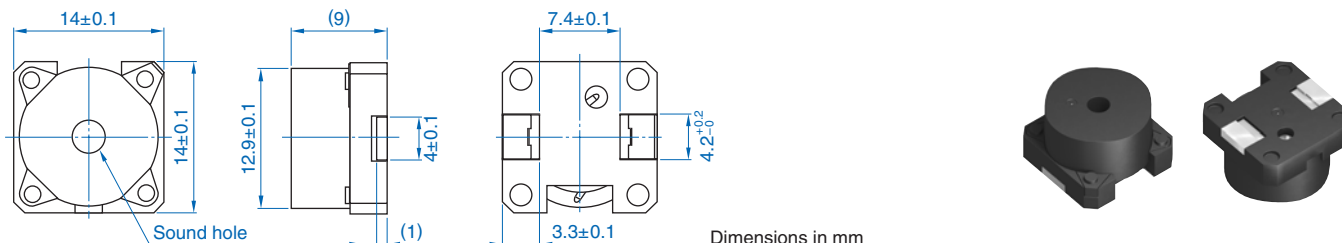

Dimensions in mm

RECOMMENDED LAND PATTERN

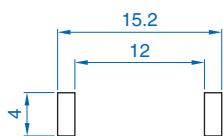

Dimensions in mm

SPECIFICATIONS

Sound pressure	84dB(A)/10cm min	[at 2.3kHz 24V _{P-P} (±12V) rectangular waves, measuring temperature:25±5°C, humidity:60±10%]
Operating temperature range	-40 to +85°C	
Storage conditions	Store the environment of the room temperature 5 to 40°C, humidity 20 to 70%RH, please use within the 6 months.	
Maximum input voltage	32V _{P-P} (±16V) max	
Minimum ordering unit	1250 pieces	

FREQUENCY SOUND PRESSURE CHARACTERISTICS

SINE WAVE DRIVE

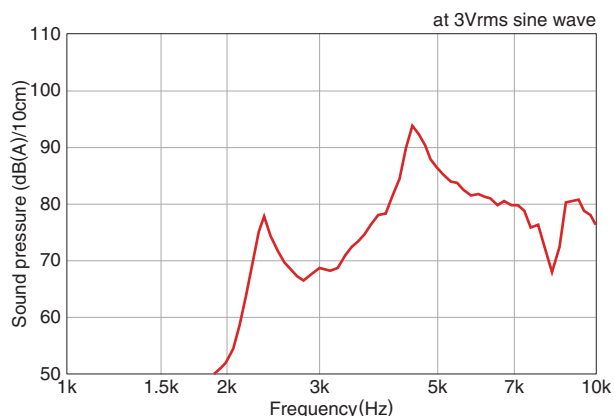

SQUARE WAVE DRIVE

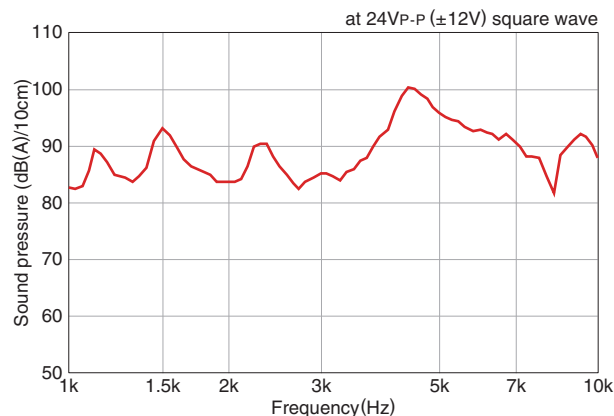

⚠ Please be sure to request delivery specifications that provide further details on the features and specifications of the products for proper and safe use. Please note that the contents may change without any prior notice due to reasons such as upgrading.

SMD type PST14

PST1423P02

RECOMMENDED REFLOW PROFILE

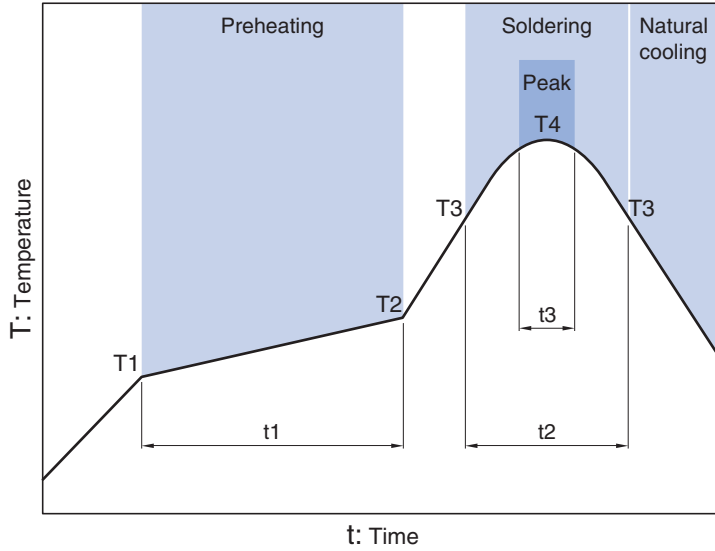

Preheating			Soldering		Peak	
Temp.	Temp.	Time	Temp.	Time	Temp.	Time
T1	T2	t1	T3	t2	T4	t3
150°C	180°C	60 to 120s	230°C	20 to 40s	250 to 260°C	5s max.

SMD type PST14

PST1423P02

■ PACKAGING STYLE

□ TAPING SPECIFICATIONS

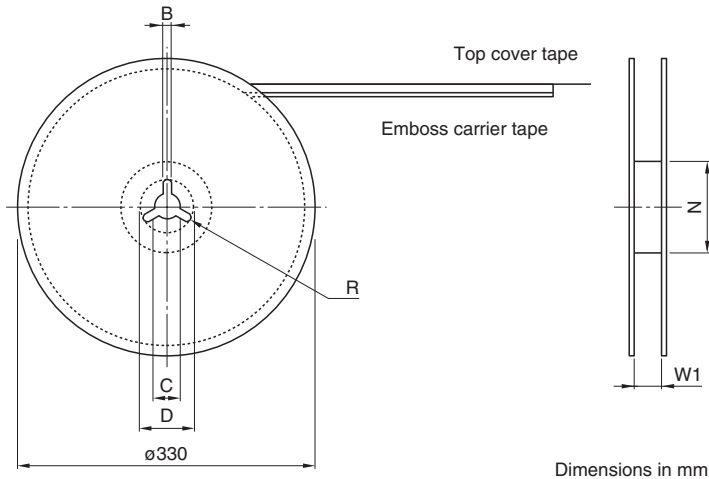

Dimensions in mm

B	C	D	N	R	W1
2.5±0.3	ø13.2±0.3	21.0±0.4	ø100±2	(R1.15)	24.5+2/-0

□ PRODUCTS INSTALL STATUS

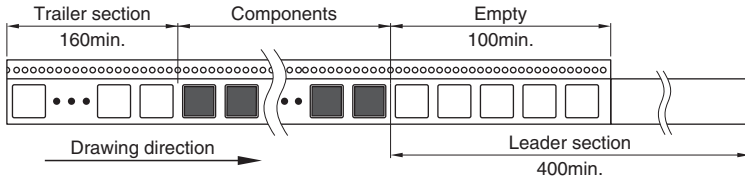

Dimensions in mm

□ Carrier tape dimensions

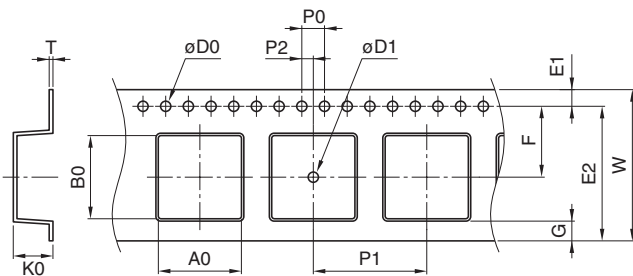

Dimensions in mm

F	G	T	W	A0	B0	D0	D1	E1	E2	K0	P0	P1	P2
11.5±0.1	(3.5)	0.5±0.05	24.0±0.3	14.5±0.2	14.5±0.2	ø1.5+0.1/-0	ø1.5±0.1	17.5±0.1	22.25+0.2/-0	9.5±0.1	4.0±0.1	20.0±0.1	2.0±0.1

⚠ Please be sure to request delivery specifications that provide further details on the features and specifications of the products for proper and safe use.
Please note that the contents may change without any prior notice due to reasons such as upgrading.

REMINDERS FOR USING THESE PRODUCTS

Before using these products, be sure to request the delivery specifications.

SAFETY REMINDERS

Please pay sufficient attention to the warnings for safe designing when using this products.

REMINDERS

Please be sure to read the specifications of TDK electromagnetic buzzer(hereinafter referred to as “the buzzer”) before use.

- Do not apply DC bias to the piezoelectric buzzer; otherwise insulation resistance may become low and affect the performance.
- Do not supply any voltage higher than applicable to the piezoelectric buzzer.
- Do not use the piezoelectric buzzer outdoors. It is designed for indoor use. If the piezoelectric buzzer has to be used outdoors, provide it with waterproofing measures; it will not operate normally if subjected to moisture.
- Do not wash the piezoelectric buzzer with solvent or allow gas to enter it while washing; any solvent that enters it may stay inside a long time and damage it.
- A piezoelectric ceramic material of approximately 100μm thick is used in the sound generator of the buzzer. Do not press the sound generator through the sound release hole otherwise the ceramic material may break. Do not stack the piezoelectric buzzers without packing.
- Do not apply any mechanical force to the piezoelectric buzzer; otherwise the case may deform and result in improper operation.
- Do not place any shielding material or the like just in front of the sound release hole of the buzzer; otherwise the sound pressure may vary and result in unstable buzzer operation. Make sure that the buzzer is not affected by a standing wave or the like.
- Be sure to solder the buzzer terminal at 350°C max.(80W max.)(soldering iron trip) within 5 seconds using a solder containing silver.
- Avoid using the piezoelectric buzzer for a long time where any corrosive gas (H₂S, etc.) exists; otherwise the parts or sound generator may corroded and result in improper operation.
- Be careful not to drop the piezoelectric buzzer.
- High safety and reliability is needed, and or, there is fear that failure, wrong movement, failure of product damages and worldly goods etc related to life and health of people, or do not use for equipment(as nuclear power equipment?-automobile?-aircraft?-medical? device) with fear that significant influence is had socially.
- The products listed on this catalog are intended for use in general electronic equipment (AV equipment, telecommunications equipment, home appliances, amusement equipment, computer equipment, personal equipment, office equipment, measurement equipment, industrial robots) under a normal operation and use condition.

The products are not designed or warranted to meet the requirements of the applications listed below, whose performance and/or quality require a more stringent level of safety or reliability, or whose failure, malfunction or trouble could cause serious damage to society, person or property.

If you intend to use the products in the applications listed below or if you have special requirements exceeding the range or conditions set forth in the each catalog, please contact us.

- | | |
|---|--|
| (1) Aerospace/aviation equipment | (8) Public information-processing equipment |
| (2) Transportation equipment (cars, electric trains, ships, etc.) | (9) Military equipment |
| (3) Medical equipment | (10) Electric heating apparatus, burning equipment |
| (4) Power-generation control equipment | (11) Disaster prevention/crime prevention equipment |
| (5) Atomic energy-related equipment | (12) Safety equipment |
| (6) Seabed equipment | (13) Other applications that are not considered general-purpose applications |
| (7) Transportation control equipment | |