



Is Now Part of



**ON Semiconductor®**

To learn more about ON Semiconductor, please visit our website at  
[www.onsemi.com](http://www.onsemi.com)

Please note: As part of the Fairchild Semiconductor integration, some of the Fairchild orderable part numbers will need to change in order to meet ON Semiconductor's system requirements. Since the ON Semiconductor product management systems do not have the ability to manage part nomenclature that utilizes an underscore (\_), the underscore (\_) in the Fairchild part numbers will be changed to a dash (-). This document may contain device numbers with an underscore (\_). Please check the ON Semiconductor website to verify the updated device numbers. The most current and up-to-date ordering information can be found at [www.onsemi.com](http://www.onsemi.com). Please email any questions regarding the system integration to [Fairchild\\_questions@onsemi.com](mailto:Fairchild_questions@onsemi.com).

ON Semiconductor and the ON Semiconductor logo are trademarks of Semiconductor Components Industries, LLC dba ON Semiconductor or its subsidiaries in the United States and/or other countries. ON Semiconductor owns the rights to a number of patents, trademarks, copyrights, trade secrets, and other intellectual property. A listing of ON Semiconductor's product/patent coverage may be accessed at [www.onsemi.com/site/pdf/Patent-Marking.pdf](http://www.onsemi.com/site/pdf/Patent-Marking.pdf). ON Semiconductor reserves the right to make changes without further notice to any products herein. ON Semiconductor makes no warranty, representation or guarantee regarding the suitability of its products for any particular purpose, nor does ON Semiconductor assume any liability arising out of the application or use of any product or circuit, and specifically disclaims any and all liability, including without limitation special, consequential or incidental damages. Buyer is responsible for its products and applications using ON Semiconductor products, including compliance with all laws, regulations and safety requirements or standards, regardless of any support or applications information provided by ON Semiconductor. "Typical" parameters which may be provided in ON Semiconductor data sheets and/or specifications can and do vary in different applications and actual performance may vary over time. All operating parameters, including "Typicals" must be validated for each customer application by customer's technical experts. ON Semiconductor does not convey any license under its patent rights nor the rights of others. ON Semiconductor products are not designed, intended, or authorized for use as a critical component in life support systems or any FDA Class 3 medical devices or medical devices with a same or similar classification in a foreign jurisdiction or any devices intended for implantation in the human body. Should Buyer purchase or use ON Semiconductor products for any such unintended or unauthorized application, Buyer shall indemnify and hold ON Semiconductor and its officers, employees, subsidiaries, affiliates, and distributors harmless against all claims, costs, damages, and expenses, and reasonable attorney fees arising out of, directly or indirectly, any claim of personal injury or death associated with such unintended or unauthorized use, even if such claim alleges that ON Semiconductor was negligent regarding the design or manufacture of the part. ON Semiconductor is an Equal Opportunity/Affirmative Action Employer. This literature is subject to all applicable copyright laws and is not for resale in any manner.



# FDB0250N807L

## N-Channel PowerTrench<sup>®</sup> MOSFET

### 80 V, 240 A, 2.2 mΩ

#### Features

- Max  $r_{DS(on)}$  = 2.2 mΩ at  $V_{GS} = 10\text{ V}$ ,  $I_D = 30\text{ A}$
- Max  $r_{DS(on)}$  = 2.7 mΩ at  $V_{GS} = 8\text{ V}$ ,  $I_D = 27\text{ A}$
- Fast Switching Speed
- Low Gate Charge
- High Performance Trench Technology for Extremely Low  $R_{DS(on)}$
- High Power and Current Handling Capability
- RoHS Compliant

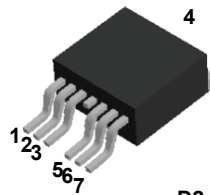


#### General Description

This N-Channel MOSFET is produced using Fairchild Semiconductor's advance PowerTrench<sup>®</sup> process that has been especially tailored to minimize the on-state resistance while maintaining superior ruggedness and switching performance for industrial applications.

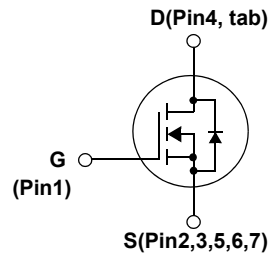
#### Applications

- Industrial Motor Drive
- Industrial Power Supply
- Industrial Automation
- Battery Operated tools
- Battery Protection
- Solar Inverters
- UPS and Energy Inverters
- Energy Storage
- Load Switch



1. Gate
2. Source/Kelvin Sense
3. Source/Kelvin Sense
4. Drain
5. Source
6. Source
7. Source

D2-PAK  
(TO263)



#### MOSFET Maximum Ratings $T_C = 25\text{ °C}$ unless otherwise noted.

Symbol	Parameter	Ratings	Units
$V_{DS}$	Drain to Source Voltage	80	V
$V_{GS}$	Gate to Source Voltage	±20	V
$I_D$	Drain Current -Continuous	$T_C = 25\text{ °C}$ (Note 5)	240
	-Continuous	$T_C = 100\text{ °C}$ (Note 5)	170
	-Pulsed	(Note 4)	1110
$E_{AS}$	Single Pulse Avalanche Energy	(Note 3)	633
$P_D$	Power Dissipation	$T_C = 25\text{ °C}$	214
	Power Dissipation	$T_A = 25\text{ °C}$ (Note 1a)	3.8
$T_J, T_{STG}$	Operating and Storage Junction Temperature Range	-55 to +150	°C

#### Thermal Characteristics

$R_{\theta JC}$	Thermal Resistance, Junction to Case	(Note 1)	0.7	°C/W
$R_{\theta JA}$	Thermal Resistance, Junction to Ambient	(Note 1a)	40	

#### Package Marking and Ordering Information

Device Marking	Device	Package	Reel Size	Tape Width	Quantity
FDB0250N807L	FDB0250N807L	D2-PAK-7L	330 mm	24 mm	800 units

## Electrical Characteristics $T_J = 25\text{ }^\circ\text{C}$ unless otherwise noted.

Symbol	Parameter	Test Conditions	Min.	Typ.	Max.	Units
--------	-----------	-----------------	------	------	------	-------

### Off Characteristics

$BV_{DSS}$	Drain to Source Breakdown Voltage	$I_D = 250\text{ }\mu\text{A}$ , $V_{GS} = 0\text{ V}$	80			V
$\frac{\Delta BV_{DSS}}{\Delta T_J}$	Breakdown Voltage Temperature Coefficient	$I_D = 250\text{ }\mu\text{A}$ , referenced to $25\text{ }^\circ\text{C}$		39		mV/ $^\circ\text{C}$
$I_{DSS}$	Zero Gate Voltage Drain Current	$V_{DS} = 64\text{ V}$ , $V_{GS} = 0\text{ V}$			1	$\mu\text{A}$
$I_{GSS}$	Gate to Source Leakage Current	$V_{GS} = \pm 20\text{ V}$ , $V_{DS} = 0\text{ V}$			$\pm 100$	nA

### On Characteristics

$V_{GS(th)}$	Gate to Source Threshold Voltage	$V_{GS} = V_{DS}$ , $I_D = 250\text{ }\mu\text{A}$	2	2.9	4	V
$\frac{\Delta V_{GS(th)}}{\Delta T_J}$	Gate to Source Threshold Voltage Temperature Coefficient	$I_D = 250\text{ }\mu\text{A}$ , referenced to $25\text{ }^\circ\text{C}$		-13		mV/ $^\circ\text{C}$
$r_{DS(on)}$	Static Drain to Source On Resistance	$V_{GS} = 10\text{ V}$ , $I_D = 30\text{ A}$		1.6	2.2	m $\Omega$
		$V_{GS} = 8\text{ V}$ , $I_D = 27\text{ A}$		1.8	2.7	
		$V_{GS} = 10\text{ V}$ , $I_D = 30\text{ A}$ , $T_J = 150\text{ }^\circ\text{C}$		3	6	
$g_{FS}$	Forward Transconductance	$V_{DS} = 10\text{ V}$ , $I_D = 30\text{ A}$		113		S

### Dynamic Characteristics

$C_{iss}$	Input Capacitance	$V_{DS} = 40\text{ V}$ , $V_{GS} = 0\text{ V}$ , $f = 1\text{ MHz}$		11000	15400	pF
$C_{oss}$	Output Capacitance			1435	2010	pF
$C_{rss}$	Reverse Transfer Capacitance			115	165	pF
$R_g$	Gate Resistance			2.8		$\Omega$

### Switching Characteristics

$t_{d(on)}$	Turn-On Delay Time	$V_{DD} = 40\text{ V}$ , $I_D = 30\text{ A}$ , $V_{GS} = 10\text{ V}$ , $R_{GEN} = 6\text{ }\Omega$		45	72	ns
$t_r$	Rise Time			64	102	ns
$t_{d(off)}$	Turn-Off Delay Time			79	126	ns
$t_f$	Fall Time			39	63	ns
$Q_g$	Total Gate Charge			143	200	nC
$Q_{gs}$	Gate to Source Gate Charge	$V_{DD} = 40\text{ V}$ , $I_D = 30\text{ A}$ , $V_{GS} = 10\text{ V}$		49		nC
$Q_{gd}$	Gate to Drain "Miller" Charge			25		nC

### Drain-Source Diode Characteristics

$I_S$	Maximum Continuous Drain to Source Diode Forward Current			240	A	
$I_{SM}$	Maximum Pulsed Drain to Source Diode Forward Current			1110	A	
$V_{SD}$	Source to Drain Diode Forward Voltage	$V_{GS} = 0\text{ V}$ , $I_S = 30\text{ A}$ (Note 2)		0.8	1.2	V
$t_{rr}$	Reverse Recovery Time	$I_F = 30\text{ A}$ , $di/dt = 100\text{ A}/\mu\text{s}$		76	121	ns
$Q_{rr}$	Reverse Recovery Charge			81	130	nC

#### Notes:

1.  $R_{\theta JA}$  is the sum of the junction-to-case and case-to-ambient thermal resistance where the case thermal reference is defined as the solder mounting surface of the drain pins.  $R_{\theta JC}$  is guaranteed by design while  $R_{\theta CA}$  is determined by the user's board design.

- a)  $40\text{ }^\circ\text{C/W}$  when mounted on a  $1\text{ in}^2$  pad of 2 oz copper.
- b)  $62.5\text{ }^\circ\text{C/W}$  when mounted on a minimum pad of 2 oz copper.

2. Pulse Test: Pulse Width <  $300\text{ }\mu\text{s}$ , Duty cycle < 2.0 %.

3.  $E_{AS}$  of 633 mJ is based on starting  $T_J = 25\text{ }^\circ\text{C}$ ,  $L = 0.3\text{ mH}$ ,  $I_{AS} = 65\text{ A}$ ,  $V_{DD} = 72\text{ V}$ ,  $V_{GS} = 10\text{ V}$ . 100% test at  $L = 0.1\text{ mH}$ ,  $I_{AS} = 94\text{ A}$ .

4. Pulsed  $I_D$  please refer to Figure "Forward Bias Safe Operating Area" for more details.

5. Computed continuous current limited to Max Junction Temperature only, actual continuous current will be limited by thermal & electro-mechanical application board design.

**Typical Characteristics**  $T_J = 25\text{ }^\circ\text{C}$  unless otherwise noted.

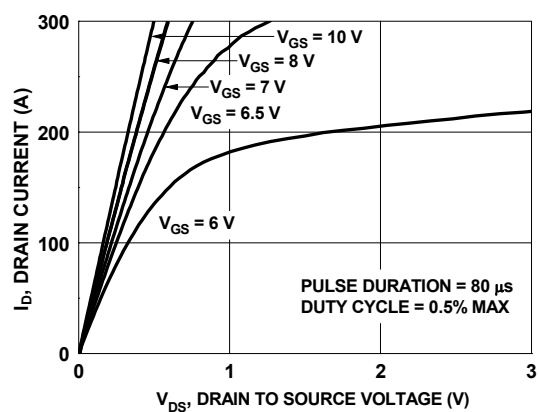


Figure 1. On Region Characteristics

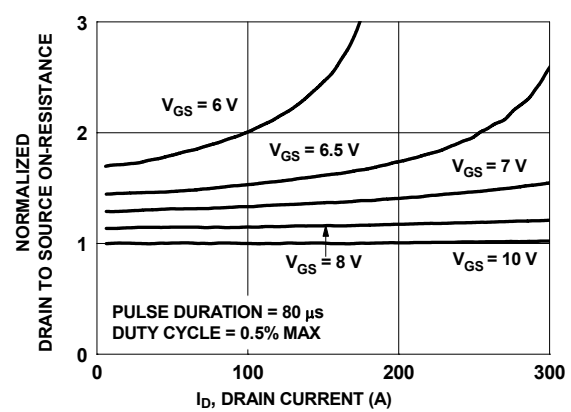


Figure 2. Normalized On-Resistance vs. Drain Current and Gate Voltage

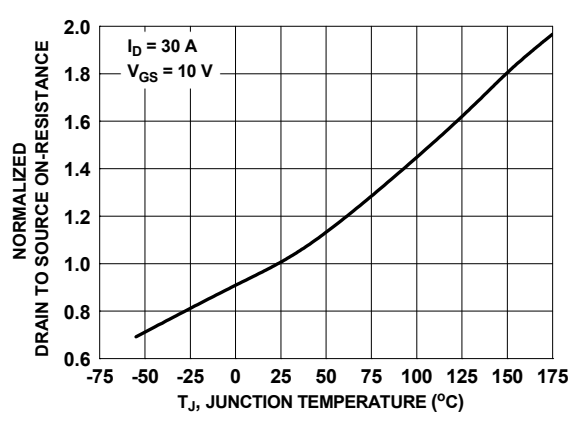


Figure 3. Normalized On Resistance vs. Junction Temperature

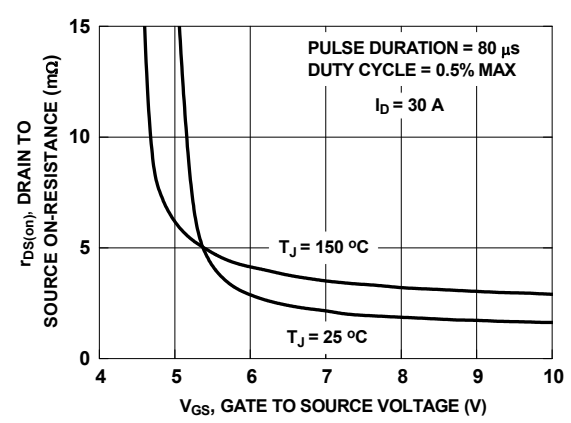


Figure 4. On-Resistance vs. Gate to Source Voltage

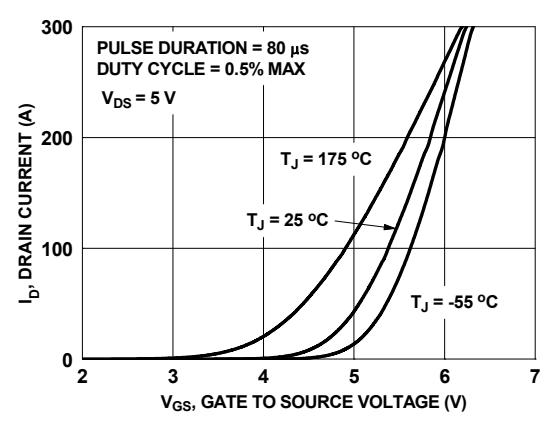


Figure 5. Transfer Characteristics

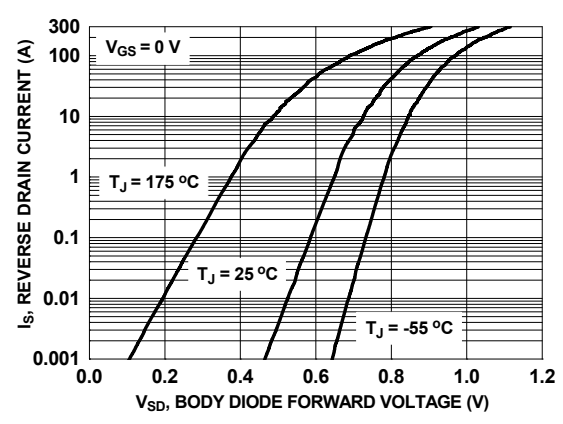
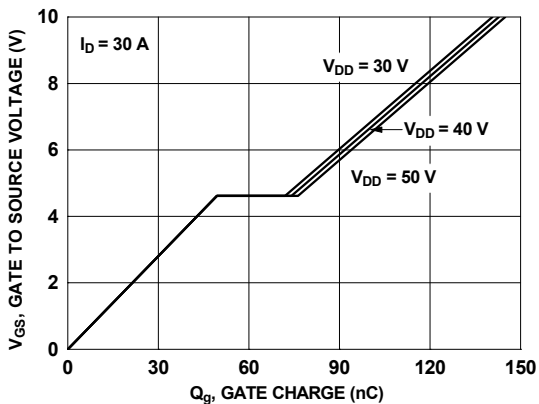
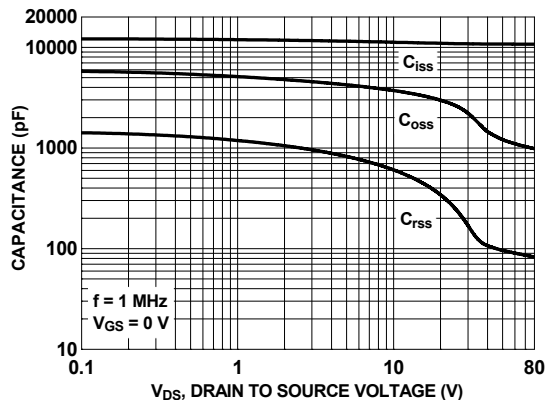


Figure 6. Source to Drain Diode Forward Voltage vs. Source Current

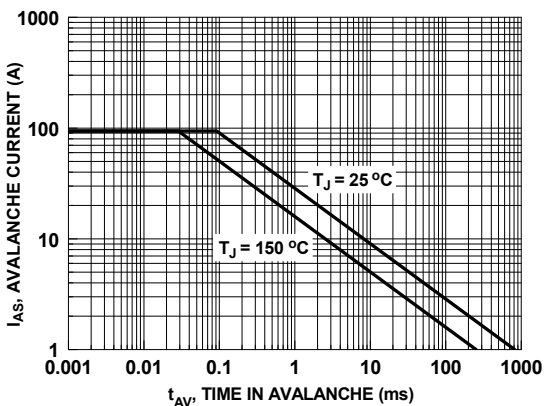
**Typical Characteristics**  $T_J = 25^\circ\text{C}$  unless otherwise noted.



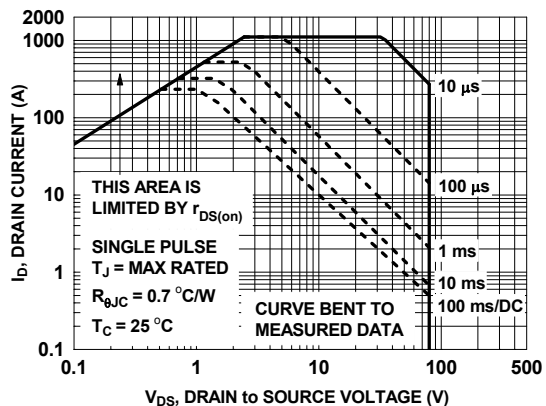
**Figure 7. Gate Charge Characteristics**



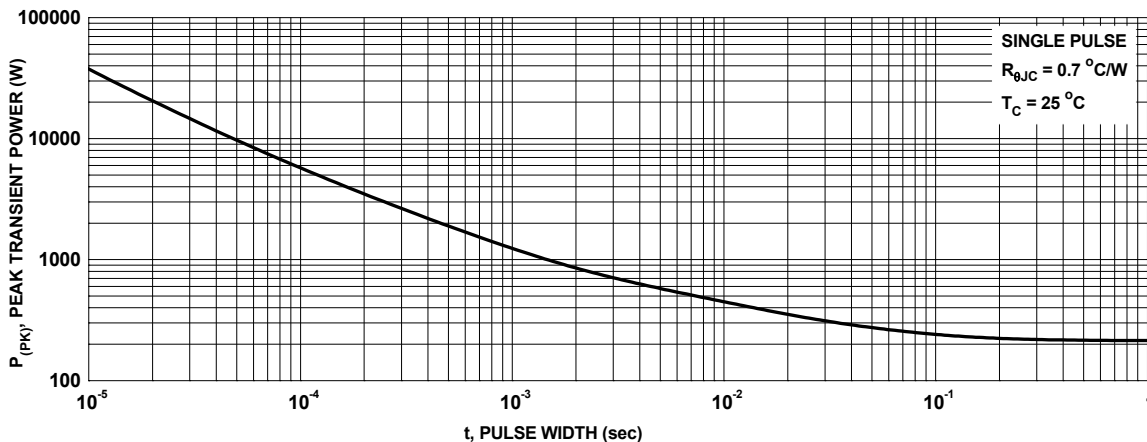
**Figure 8. Capacitance vs. Drain to Source Voltage**



**Figure 9. Unclamped Inductive Switching Capability**

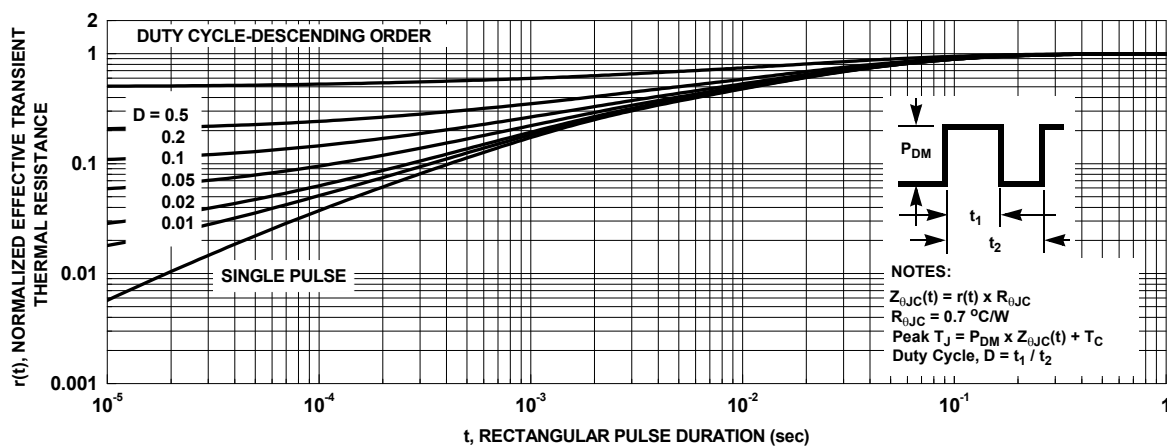


**Figure 10. Forward Bias Safe Operating Area**

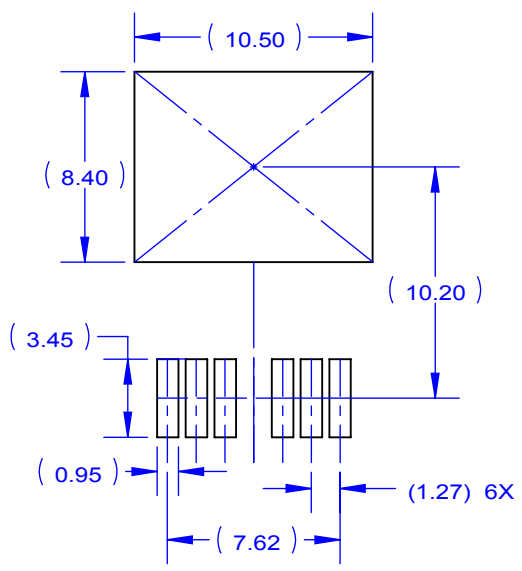
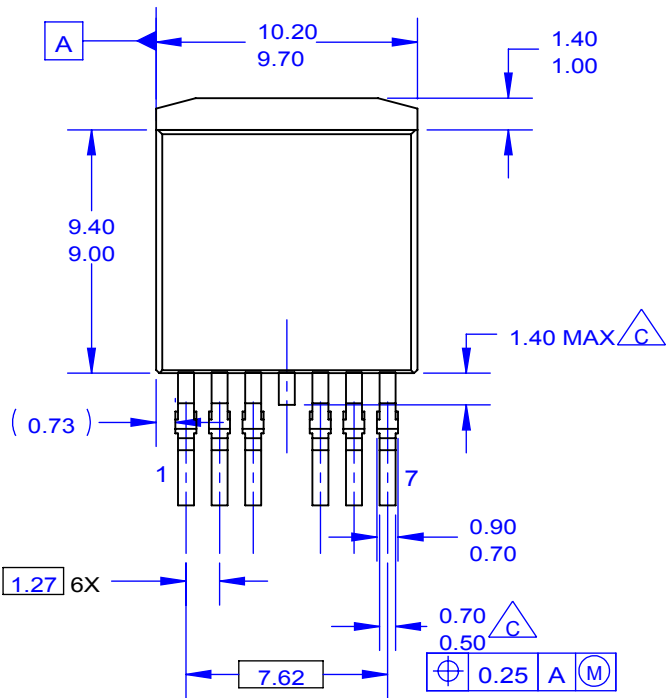


**Figure 11. Single Pulse Maximum Power Dissipation**

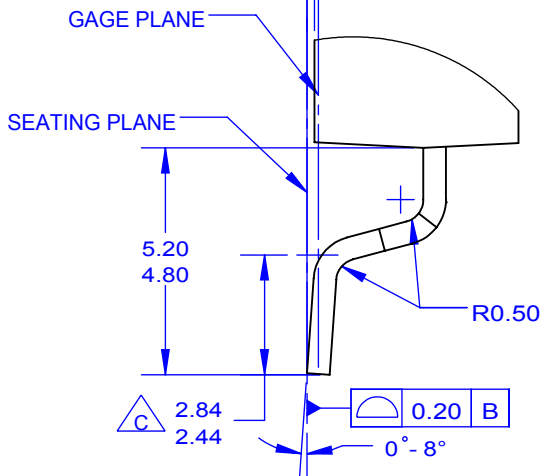
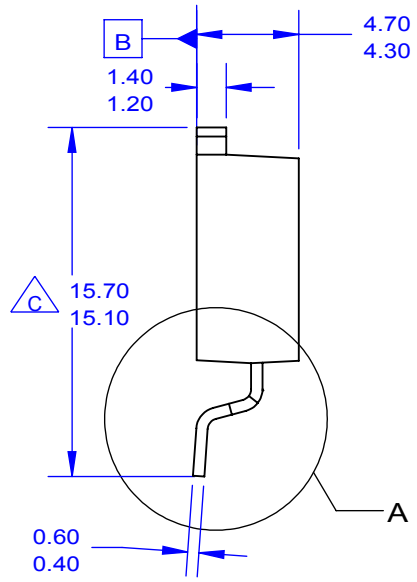
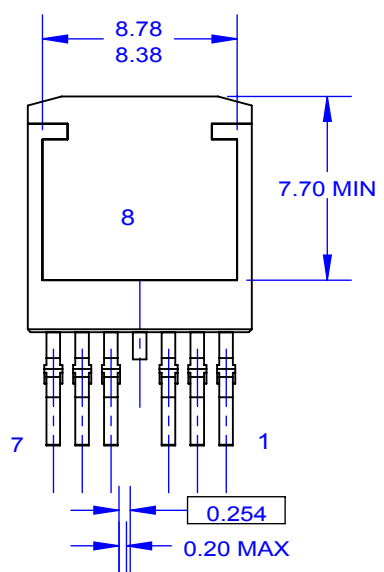
**Typical Characteristics**  $T_J = 25\text{ }^\circ\text{C}$  unless otherwise noted.



**Figure 12. Junction-to-Case Transient Thermal Response Curve**



LAND PATTERN RECOMMENDATION



DETAIL A  
SCALE 2:1

NOTES:

- A. PACKAGE CONFORMS TO JEDEC TO-263 VARIATION CB EXCEPT WHERE NOTED.
- B. ALL DIMENSIONS ARE IN MILLIMETERS.
- C. OUT OF JEDEC STANDARD VALUE.
- D. DIMENSION AND TOLERANCE AS PER ASME Y14.5-1994.
- E. DIMENSIONS ARE EXCLUSIVE OF BURRS, MOLD FLASH AND TIE BAR PROTRUSIONS.
- F. LAND PATTERN RECOMMENDATION PER IPC TO127P1524X465-8N.
- G. DRAWING FILE NAME: TO263A07REV5.

ON Semiconductor and  are trademarks of Semiconductor Components Industries, LLC dba ON Semiconductor or its subsidiaries in the United States and/or other countries. ON Semiconductor owns the rights to a number of patents, trademarks, copyrights, trade secrets, and other intellectual property. A listing of ON Semiconductor's product/patent coverage may be accessed at [www.onsemi.com/site/pdf/Patent-Marking.pdf](http://www.onsemi.com/site/pdf/Patent-Marking.pdf). ON Semiconductor reserves the right to make changes without further notice to any products herein. ON Semiconductor makes no warranty, representation or guarantee regarding the suitability of its products for any particular purpose, nor does ON Semiconductor assume any liability arising out of the application or use of any product or circuit, and specifically disclaims any and all liability, including without limitation special, consequential or incidental damages. Buyer is responsible for its products and applications using ON Semiconductor products, including compliance with all laws, regulations and safety requirements or standards, regardless of any support or applications information provided by ON Semiconductor. "Typical" parameters which may be provided in ON Semiconductor data sheets and/or specifications can and do vary in different applications and actual performance may vary over time. All operating parameters, including "Typicals" must be validated for each customer application by customer's technical experts. ON Semiconductor does not convey any license under its patent rights nor the rights of others. ON Semiconductor products are not designed, intended, or authorized for use as a critical component in life support systems or any FDA Class 3 medical devices or medical devices with a same or similar classification in a foreign jurisdiction or any devices intended for implantation in the human body. Should Buyer purchase or use ON Semiconductor products for any such unintended or unauthorized application, Buyer shall indemnify and hold ON Semiconductor and its officers, employees, subsidiaries, affiliates, and distributors harmless against all claims, costs, damages, and expenses, and reasonable attorney fees arising out of, directly or indirectly, any claim of personal injury or death associated with such unintended or unauthorized use, even if such claim alleges that ON Semiconductor was negligent regarding the design or manufacture of the part. ON Semiconductor is an Equal Opportunity/Affirmative Action Employer. This literature is subject to all applicable copyright laws and is not for resale in any manner.

## PUBLICATION ORDERING INFORMATION

### LITERATURE FULFILLMENT:

Literature Distribution Center for ON Semiconductor  
19521 E. 32nd Pkwy, Aurora, Colorado 80011 USA  
**Phone:** 303-675-2175 or 800-344-3860 Toll Free USA/Canada  
**Fax:** 303-675-2176 or 800-344-3867 Toll Free USA/Canada  
**Email:** [orderlit@onsemi.com](mailto:orderlit@onsemi.com)

**N. American Technical Support:** 800-282-9855 Toll Free  
USA/Canada  
**Europe, Middle East and Africa Technical Support:**  
Phone: 421 33 790 2910  
**Japan Customer Focus Center**  
Phone: 81-3-5817-1050

**ON Semiconductor Website:** [www.onsemi.com](http://www.onsemi.com)  
**Order Literature:** <http://www.onsemi.com/orderlit>  
For additional information, please contact your local  
Sales Representative