

### DST1040S

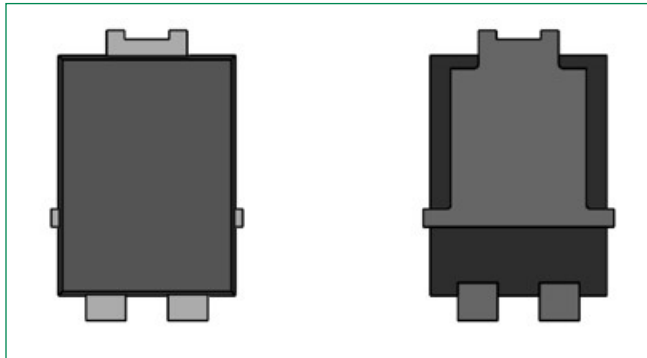

#### Pin out

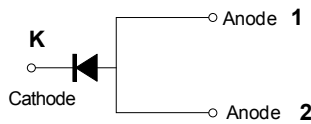

#### Description

Littelfuse DST series Ultra Low  $V_F$  Schottky Barrier Rectifier is designed to meet the general requirements of commercial and industry applications by providing high temperature, low leakage and lower  $V_F$  products.

It is suitable for high frequency switching mode power supply, free-wheeling diodes and polarity protection diodes.

#### Features

- Ultra low forward voltage drop
- High frequency operation
- MSL: Level 1 - unlimited
- High junction temperature capability
- Trench MOS Schottky technology
- Single die in TO-277B Package
- Pb-free E3 means 2nd level interconnect is Pb-free and the terminal finish material is tin(Sn) (IPC/ JEDEC J-STD-609A.01)

#### Applications

- Switching mode power supply
- DC/DC converters
- Free-Wheeling diodes
- Polarity Protection Diodes

#### Maximum Ratings

Parameters	Symbol	Test Conditions	Max	Unit
Peak Inverse Voltage	$V_{RWM}$	-	40	V
Average Forward Current (per device) *	$I_{F(AV)}$	50% duty cycle @ $T_M = 121^\circ\text{C}$ rectangular wave form	10	A
Peak One Cycle Non-Repetitive Surge Current (per leg)	$I_{FSM}$	8.3 ms, half Sine pulse	150	A

\* Mounted on 30 mm x 30 mm pad areas aluminum PCB

#### Electrical Characteristics

Parameters	Symbol	Test Conditions	Typ	Max	Unit
Forward Voltage Drop (per leg) *	$V_{F1}$	@5A, Pulse, $T_J = 25^\circ\text{C}$	0.43	-	V
		@10A, Pulse, $T_J = 25^\circ\text{C}$	0.49	0.57	
	$V_{F2}$	@5A, Pulse, $T_J = 125^\circ\text{C}$	0.33	-	
		@10A, Pulse, $T_J = 125^\circ\text{C}$	0.41	-	
Reverse Current (per leg) *	$I_{R1}$	@ $V_R = \text{rated } V_R, T_J = 25^\circ\text{C}$	0.017	0.80	mA
	$I_{R2}$	@ $V_R = \text{rated } V_R, T_J = 125^\circ\text{C}$	15	100	
Junction Capacitance (per leg)	$C_T$	@ $V_R = 5V, T_C = 25^\circ\text{C}, f_{SIG} = 1\text{MHz}$	639	-	pF

\* Pulse Width < 300 $\mu\text{s}$ , Duty Cycle < 2%

**Thermal-Mechanical Specifications**

Parameters	Symbol	Test Conditions	Max	Unit
Junction Temperature	$T_J$		-55 to +150	°C
Storage Temperature	$T_{stg}$		-55 to +150	°C
Typical Thermal Resistance	$R_{thJM}$	DC operation	4	°C/W
Approximate Weight	wt		0.08	g
Case Style		TO-277B		

 Mounted on 30 mm x 30 mm aluminum PCB; thermal resistance  $R_{thJM}$  - junction to mount

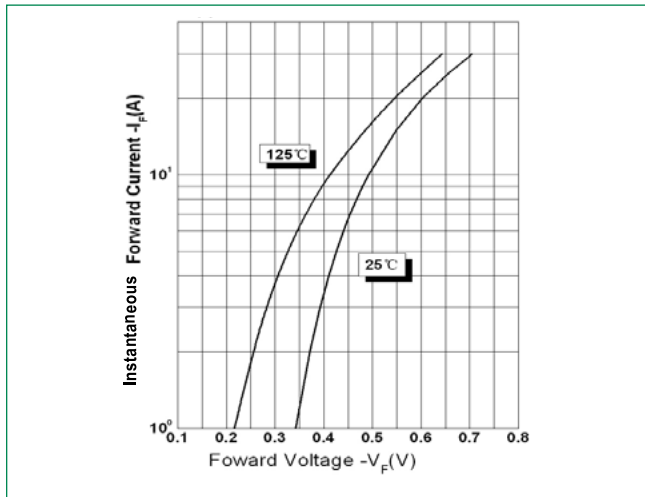
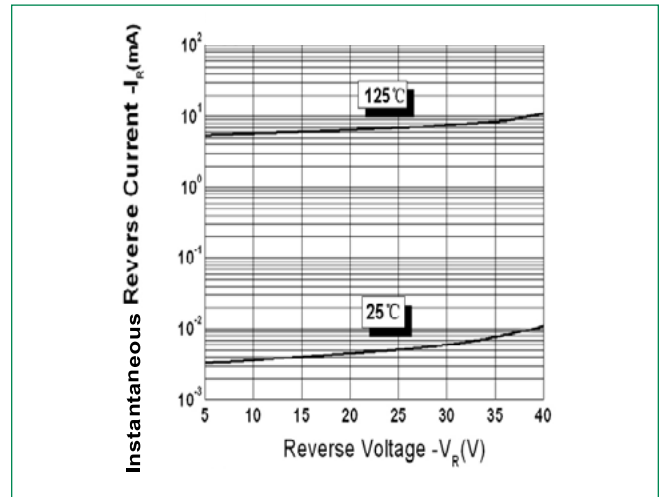
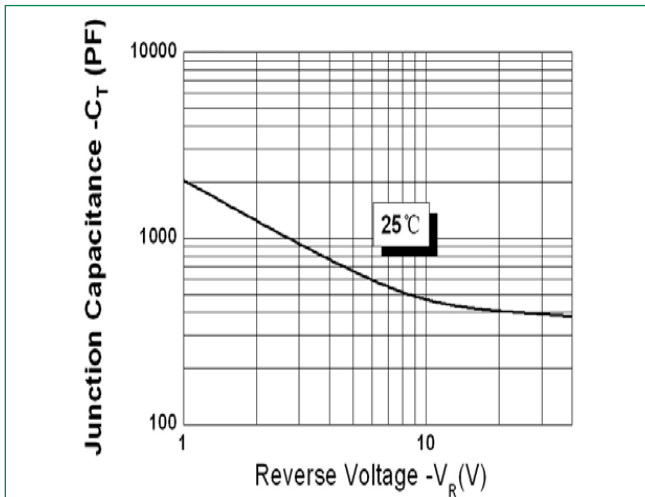
**Figure 1: Typical Forward Characteristics**

**Figure 2: Typical Reverse Characteristics**

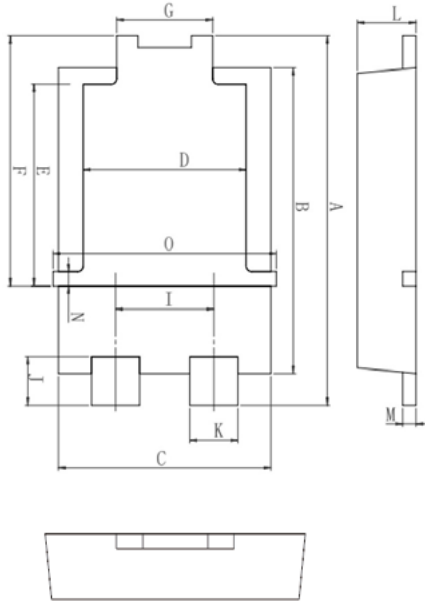
**Figure 3: Typical Junction Capacitance**

**Dimensions-TO-277B**

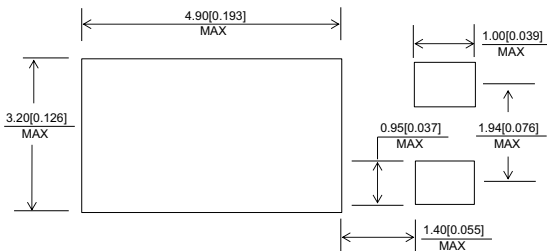

Symbol	Millimeters		
	Min	Typ	Max
A	6.30	6.50	6.70
B	5.28	5.38	5.48
C	3.88	3.98	4.08
D	2.90	3.05	3.20
E	3.40	3.55	3.70
F	4.20	4.40	4.60
G	1.70	1.80	1.90
I	1.74	1.84	1.94
J	0.65	0.85	1.05
K	0.85	0.90	0.95
L	0.95	1.10	1.25
M	0.20	0.25	0.30
N	0.25	0.40	0.55
O	4.00	4.05	4.25

**Mounting Pad Layout**



**Part Numbering and Marking System**



- DST = Device Type
- 10 = Forward Current (10A)
- 40 = Reverse Voltage (40V)
- S = Package Type
- LF = Littelfuse
- YY = Year
- WW = Week
- L = Lot Number

**Packing Options**

Part Number	Marking	Packing Mode	M.O.Q
DST1040S	DST1040S	5000pcs / Reel	5000

**Carrier Tape & Reel Specification**

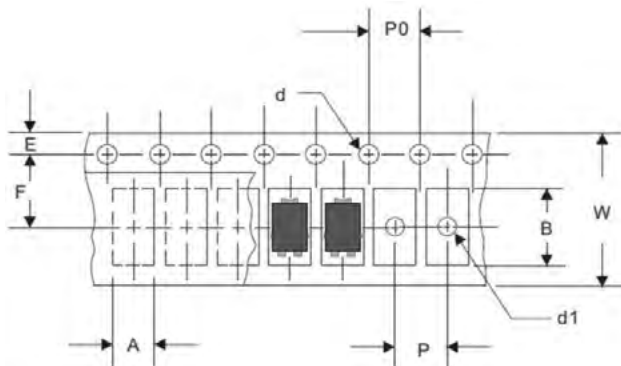

Symbol	Millimeters	
	Min	Max
A	4.28	4.48
B	6.80	7.00
d	1.40	1.60
d1	-	1.50
E	1.65	1.85
F	5.40	5.60
P	7.90	8.10
P0	3.90	4.10
W	11.70	12.30

# Mouser Electronics

Authorized Distributor

Click to View Pricing, Inventory, Delivery & Lifecycle Information:

[Littelfuse:](#)

[DST1040S](#)