

Open Air Resistor Metal Element Current Sense

OAR & OAR-TP Series

- Power ratings of 1, 3, & 5W @ 85°C
- Superior surge performance
- Hot spot isolated from PCB material
- Resistance wire TCR $\pm 20\text{ppm}/^\circ\text{C}$
- Tolerances to 1%



 All Pb-free parts comply with EU Directive 2011/65/EU amended by (EU) 2015/863 (RoHS3)

Electrical Data

Part Number	Power Rating @ 85°C (watts)	Resistance Range (mΩ)	Tolerance (±%)	Wire TCR (±ppm/°C)	Inductance (nH)
OAR-1 (TP)	1.0	3, 5, 6, 8, 10, 12, 15, 20, 25, 30, 35, 40, 50, 60, 70, 80, 100	1, 2 ¹ , 5	<R005: 180, ≥R005 & <R025: 20, ≥R025: 30	<10
OAR-3 (TP)	3.0	2.5, 3, 4, 5, 6, 7, 10, 15, 20, 25, 30, 40, 45, 50, 60, 70, 100		<R004: 180, ≥R004 & <R040: 20, ≥R040: 30	
OAR-5 (TP)	5.0	3, 4, 5, 6, 6.2, 10, 12, 15, 20, 25, 30, 40, 50		<R005: 180, ≥R005 & <R025: 20, ≥R025: 30	

Notes:

¹ ±2% tolerance may be available on request, but ±1% and ±5% are preferred.
Please contact factory for resistance values not listed

Environmental Data

Load Life (1000 hours @ 25°C)	$\Delta R/R < 1\%$
Moisture (no load for 1000 hours)	$\Delta R/R < 1\%$
Temperature Cycling (-40°C to +125°C for 1000 cycles)	$\Delta R/R < 1\%$
Operating Temperature	-40°C to +125°C

General Note

TT Electronics reserves the right to make changes in product specification without notice or liability.
All information is subject to TT Electronics' own data and is considered accurate at time of going to print.

Open Air Resistor Metal Element Current Sense

OAR & OAR-TP Series



Physical Data

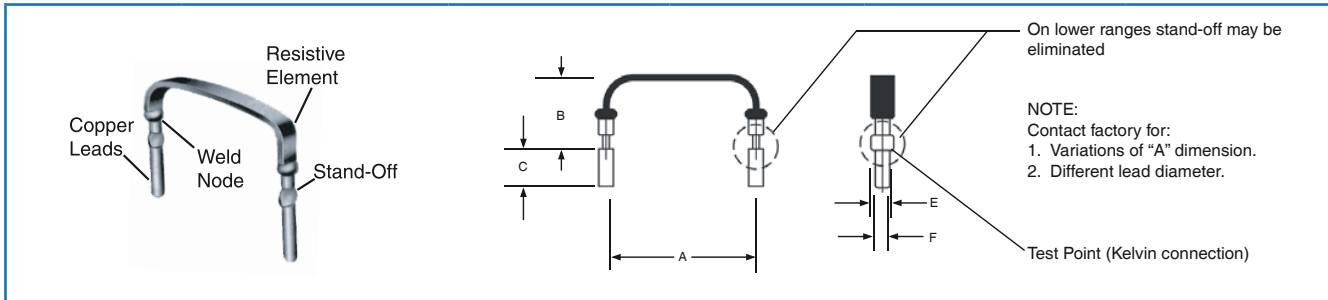

Type	A	B ¹ max	C	E	F
OAR1	0.45 +0.04/-0.02 (11.43 +1.02/-0.51)	0.32 (8.12)	0.125 ±0.03 (3.18 ±0.76)	0.065 +0.01/-0.005 (1.65 +0.25/-0.13)	0.04 ±0.002 (1.02 ±0.05)
OAR1TP	0.197 +0.04/-0.03 (5.0 +1.0/-0.8)	0.45 (11.4)			
OAR3	0.60 +0.04/-0.02 (15.24 +1.02/-0.51)	0.92 (23.4)			
OAR3TP <R005	0.275 +0.04/-0.03 (7.0 +1.0/-0.8)	1.12 (28.5)			
OAR3TP ≥R005	0.197 +0.04/-0.03 (5.0 +1.0/-0.8)				
OAR5	0.80 +0.04/-0.02 (20.32 +1.02/-0.51)	0.88 (22.4)			
OAR5TP	0.275 +0.04/-0.03 (7.0 +1.0/-0.8)	1.14 (29)			

Note 1: Nominal height varies with ohmic value.

Thermal Image Data

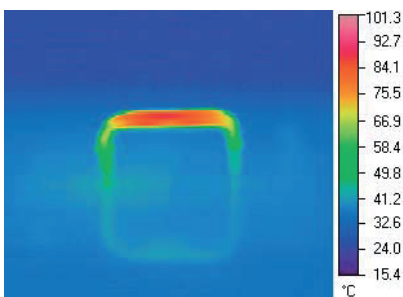

OAR-1 5 mΩ @ 1 Watt

Hot Spot: 87°C
Solder Joint: 45°C

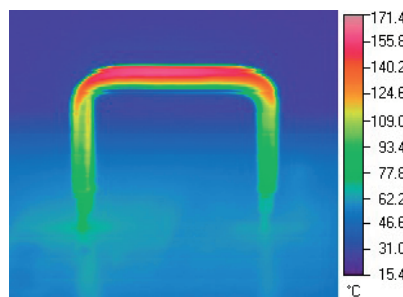

OAR-3 5 mΩ @ 3 Watt

Hot Spot: 160°C
Solder Joint: 70°C

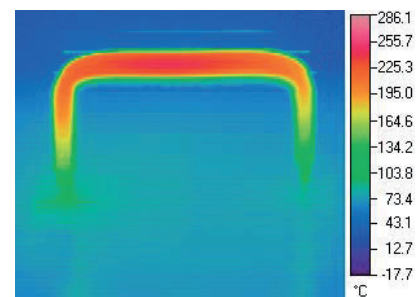

OAR-5 5 mΩ @ 5 Watt

Hot Spot: 230°C
Solder Joint: 96°C

The thermal images (not simulations) above are of the OAR products at their respective power rating. Notice the solder joint temperature is much lower than the hotspot. The unique construction of the OAR isolates the temperature of the hotspot from the circuit board material preventing damage to the circuit board. Additionally, the thermal energy is dissipated to the air instead of being conducted into the circuit board potentially causing a nearby power component to exceed its rating.

The standard test circuit board consists of a four layer FR4 material with 2 ounce (70µm) outer layers and 1 ounce (35µm) inner layers, which is typical of many industry designs. The test conditions were in ambient temperature conditions, approximately 22 °C with no forced air. Contact TT electronics for more details or for other thermal image test data for specific resistance values and power levels.

General Note

TT Electronics reserves the right to make changes in product specification without notice or liability. All information is subject to TT Electronics' own data and is considered accurate at time of going to print.

Power Derating

The typical power derating curves are based on conservative design concepts that extend from film based products. The OAR is a solid metal alloy construction that can withstand comparably greater operating power levels than conservative design models permit. Typically the resistive alloys can withstand temperatures in excess of 300°C. Therefore, system thermal design considerations are a more significant design parameter due to the heat limitations of solder joints and/or circuit board substrate materials.

Pulse/Surge Chart @ 50 msec duration

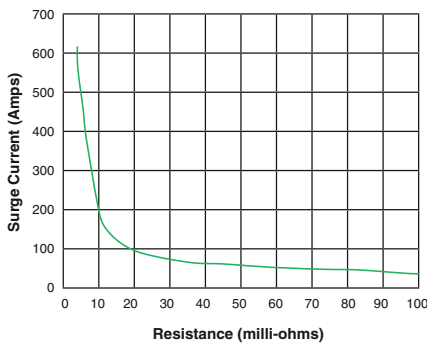

OAR-1(TP)

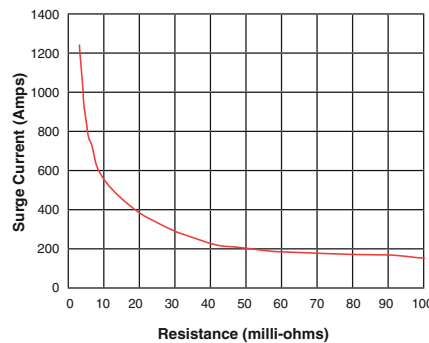

OAR-3(TP)

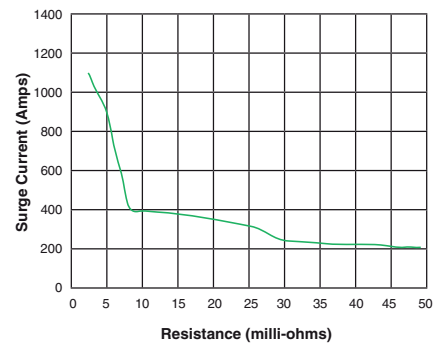

OAR-5(TP)

The Surge current charts are approximations of the capabilities of the OAR product and should not be used to the exclusion of actual testing. The relative high surge currents depicted in the charts are as a result of the robust all metal welded construction and the heat carrying capability of metal. Additionally the OAR resistive wire provides large relative cross section for current flow as compared to other resistor technologies, such as thin film, thick film, or metal strip.

General Note

TT Electronics reserves the right to make changes in product specification without notice or liability. All information is subject to TT Electronics' own data and is considered accurate at time of going to print.

Open Air Resistor Metal Element Current Sense

OAR & OAR-TP Series



Ordering Data

This product has two valid part numbers:

European (Welwyn) Part Number: OAR3-R01JI (OAR3, 10 milliohms $\pm 5\%$, Pb-free)

O	A	R	3			-	R	0	1	J	I
1		2		3			4		5		

1 Type	2 Pitch	3 Value	4 Tolerance	5 Packing
OAR1	Omit for standard	3-5 characters	F = $\pm 1\%$	I = Bulk
OAR3	TP = Tight Pitch	See Electrical Data	¹ G = $\pm 2\%$	
OAR5		R = ohms	J = $\pm 5\%$	

Note 1 - $\pm 2\%$ tolerance may be available on request, but $\pm 1\%$ and $\pm 5\%$ are preferred.

USA (IRC) Part Number: OAR3R010JLF (OAR3, 10 milliohms $\pm 5\%$, Pb-free)

O	A	R	3			R	0	1	0	J	L	F
1		2		3			4		5			

1 Type	2 Pitch	3 Value	4 Tolerance	5 Termination
OAR1	Omit for standard	4/5 characters	F = $\pm 1\%$	Omit for SnPb
OAR3	TP = Tight Pitch	See Electrical Data	¹ G = $\pm 2\%$	LF = Pb-free
OAR5		R = ohms	J = $\pm 5\%$	

Note 1 - $\pm 2\%$ tolerance may be available on request, but $\pm 1\%$ and $\pm 5\%$ are preferred.

General Note

TT Electronics reserves the right to make changes in product specification without notice or liability.
All information is subject to TT Electronics' own data and is considered accurate at time of going to print.

BI Technologies IRC Welwyn

www.ttelectronics.com/resistors