

RMCF / RMCP Series

General Purpose Thick Film Standard Power and High-Power Chip Resistor

Stackpole Electronics, Inc.

Resistive Product Solutions

Features:

- RMCF – standard power ratings
- RMCP – high power ratings
- Nickel barrier terminations standard
- Power derating from 100% at 70 °C to zero at +155 °C
- AEC-Q200 Compliant (except RMCP0201)
- RoHS compliant and halogen free



Electrical Specifications - RMCF							
Type / Code	Power Rating (W) @ 70°C	Maximum Working Voltage (1)	Maximum Overload Voltage	Max. Jumper Current (Amp)	Resistance Temperature Coefficient	Ohmic Range (Ω) and Tolerance (2)	
						1%	5%
RMCF01005	0.03	15	30	0.5	± 300 ppm/°C	10 - 97.6	
					± 200 ppm/°C	100 - 1 M	
RMCF0201	0.05	25	50	0.5	± 400 ppm/°C	1 - 9.76	
					± 200 ppm/°C	10 - 10 M	
RMCF0402	0.063	50	100	1	± 200 ppm/°C	1 - 9.76 (4)	
					± 100 ppm/°C	10 - 1 M	
					± 200 ppm/°C	1.02 M - 10 M	1.1 M - 20 M
RMCF0603	0.1	75	150	1	± 500 ppm/°C	0.1 - 0.499	
					± 400 ppm/°C	0.5 - 0.976	
					± 200 ppm/°C	1 - 9.76	1 - 20 M
					± 100 ppm/°C	10 - 1 M	-
RMCF0805	0.125	150	300	2	± 200 ppm/°C	0.1 - 9.76	0.1 - 20 M
					± 100 ppm/°C	10 - 1 M	-
					± 200 ppm/°C	1.02 M - 10 M	-
RMCF1206	0.25	200	400	2	± 200 ppm/°C	0.1 - 9.76	0.1 - 20 M
					± 100 ppm/°C	10 - 1 M	-
					± 200 ppm/°C	1.02 M - 10 M	-
RMCF1210	0.33 (3)	200	400	3	± 200 ppm/°C	0.1 - 0.976	
					± 400 ppm/°C	1 - 9.76	
					± 200 ppm/°C	-	10 - 20 M
					± 100 ppm/°C	10 - 10 M	-
RMCF2010	0.75	200	400	3	± 200 ppm/°C	0.1 - 0.976	
					± 400 ppm/°C	1 - 9.76	
					± 200 ppm/°C	-	10 - 10 M
					± 100 ppm/°C	10 - 10 M	-
RMCF2512	1	200	400	3	± 200 ppm/°C	0.1 - 0.976	
					± 400 ppm/°C	1 - 9.76	
					± 200 ppm/°C	-	10 - 10 M
					± 100 ppm/°C	10 - 10 M	-

Notes: (1) Lesser of $\sqrt{P \cdot R}$ or maximum working voltage
 (2) Contact factory for extended ohmic values
 (3) Power rating is 0.5 W for ohmic values 1 K Ω and below
 (4) Contact factory for lower ohmic values

RMCF / RMCP Series

General Purpose Thick Film Standard Power and High-Power Chip Resistor

Stackpole Electronics, Inc.

Resistive Product Solutions

Electrical Specifications - RMCP

Type / Code	Power Rating (W) @ 70°C	Maximum Working Voltage ⁽¹⁾	Maximum Overload Voltage	Max. Jumper Current (Amp)	Resistance Temperature Coefficient	Ohmic Range (Ω) and Tolerance ⁽²⁾
						1%, 5%
RMCP0201	0.063	25	50	1	-200 / +400 ppm/°C	1 - 9.76
					± 200 ppm/°C	10 - 1 M
RMCP0402	0.125	50	100	1.5	± 200 ppm/°C	1 - 9.76
					± 100 ppm/°C	10 - 1 M
RMCP0603	0.25	75	150	2	± 200 ppm/°C	1 - 9.76
					± 100 ppm/°C	10 - 1 M
RMCP0805	0.33	150	300	2.5	± 200 ppm/°C	1 - 9.76
					± 100 ppm/°C	10 - 1 M
RMCP1206	0.33	200	400	3.5	± 200 ppm/°C	1 - 9.76
					± 100 ppm/°C	10 - 1 M
RMCP1210	0.5	200	400	5	± 200 ppm/°C	1 - 9.76
					± 100 ppm/°C	10 - 1 M
RMCP2010	1	200	400	6	± 200 ppm/°C	1 - 9.76
					± 100 ppm/°C	10 - 1 M
RMCP2512	2	250	500	7	± 200 ppm/°C	1 - 9.76
					± 100 ppm/°C	10 - 1 M

Notes: (1) Lesser of $\sqrt{P \cdot R}$ or maximum working voltage
 (2) Contact factory for extended ohmic values

Electrical Specifications - Jumper

Type / Code	Jumper Rated Current (amps)	Max. Overload Current (amps)*	Jumper Resistance Value (Ω)
RMCF0201	0.5	1	0.05 max.
RMCF0402	1	3	
RMCF0603	1	3	
RMCF0805	1	3	
RMCF1206	2	10	
RMCF1210	2	10	
RMCF2010	2	10	
RMCF2512	2	10	

* < 1 second and 1 time

Mechanical Specifications

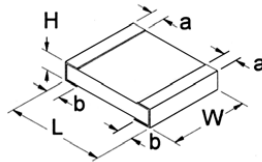

Type / Code	Average Unit Weight (mg)	L Body Length	W Body Width	H Body Height	a Top Termination	b Bottom Termination	Unit
RMCF01005	0.07	0.016 ± 0.0008 0.40 ± 0.02	0.008 ± 0.0008 0.20 ± 0.02	0.005 ± 0.0008 0.13 ± 0.02	0.004 ± 0.0012 0.10 ± 0.03	0.004 ± 0.0012 0.10 ± 0.03	inches mm
RMCF0201 RMCP0201	0.16	0.024 ± 0.0012 0.60 ± 0.03	0.012 ± 0.0012 0.30 ± 0.03	0.009 ± 0.0012 0.23 ± 0.03	0.006 ± 0.002 0.15 ± 0.05	0.006 ± 0.002 0.15 ± 0.05	inches mm
RMCF0402 RMCP0402	0.57 0.62	0.039 ± 0.004 1.00 ± 0.10	0.020 ± 0.002 0.50 ± 0.05	0.012 ± 0.002 0.30 ± 0.05	0.008 ± 0.004 0.20 ± 0.10	0.010 ± 0.006 0.25 ± 0.15	inches mm
RMCF0603 RMCP0603	1.88 2.04	0.061 ± 0.006 1.55 ± 0.15	0.031 ± 0.006 0.80 ± 0.15	0.018 ± 0.004 0.45 ± 0.10	0.012 ± 0.008 0.30 ± 0.20	0.012 ± 0.008 0.30 ± 0.20	inches mm
RMCF0805 RMCP0805	5.00 4.37	0.079 ± 0.008 2.00 ± 0.20	0.049 ± 0.004 1.25 ± 0.10	0.020 ± 0.006 0.50 ± 0.15	0.014 ± 0.010 0.35 ± 0.25	0.014 ± 0.010 0.35 ± 0.25	inches mm
RMCF1206 RMCP1206	8.86 8.95	0.126 ± 0.010 3.20 ± 0.25	0.063 ± 0.006 1.60 ± 0.15	0.022 ± 0.006 0.55 ± 0.15	0.020 ± 0.012 0.50 ± 0.30	0.020 ± 0.012 0.50 ± 0.30	inches mm

Rev Date: 05/19/2020

This specification may be changed at any time without prior notice
 Please confirm technical specifications before you order and/or use.

Mechanical Specifications (cont.)

Type / Code	Average Unit Weight (mg)	L Body Length	W Body Width	H Body Height	a Top Termination	b Bottom Termination	Unit
RMCF1210	15.55	0.126 ± 0.010	0.098 ± 0.010	0.022 ± 0.006	0.020 ± 0.012	0.020 ± 0.012	inches
RMCP1210	15.96	3.20 ± 0.25	2.50 ± 0.25	0.55 ± 0.15	0.50 ± 0.30	0.50 ± 0.30	mm
RMCF2010	23.56	0.197 ± 0.008	0.098 ± 0.008	0.022 ± 0.006	0.024 ± 0.012	0.024 ± 0.014	inches
RMCP2010	24.24	5.00 ± 0.20	2.50 ± 0.20	0.55 ± 0.15	0.60 ± 0.30	0.60 ± 0.35	mm
RMCF2512	40.02	0.248 ± 0.008	0.126 ± 0.010	0.022 ± 0.006	0.024 ± 0.012	0.024 ± 0.014	inches
RMCP2512	39.45	6.30 ± 0.20	3.20 ± 0.25	0.55 ± 0.15	0.60 ± 0.30	0.60 ± 0.35	mm

Performance Characteristics

Test	Test Specifications	Test Conditions (JIS-C 5202)
Short Time Overload	± (2% + 0.1 Ω)	2.5 X rated voltage for 5 seconds
	Jumper: Max 0.05 Ω after test	0201 = 1 A 0402 / 0603 / 0805 = 2.5 A 1206 / 1210 / 2010 / 2512 = 5 A
Dielectric Withstanding Voltage	No flashover or breakdown	100 VAC, 1 minute
Resistance to Soldering Heat	± 1%	260 °C ± 5 °C, for 10 seconds ± 0.5 seconds (Solder Bath)
Solderability	95% coverage, minimum	235 °C ± 5 °C, for 2 seconds ± 0.5 seconds (Colophonium flux)
Temperature Cycle	± (1% + 0.05 Ω) Jumper (< 0.05 Ω)	-65 °C: 30 minutes 25 °C: 2 to 3 minutes 155 °C: 30 minutes 25 °C: 2 to 3 minutes (5 Cycles)
Endurance (Damp load)	± (3% + 0.1 Ω) Jumper (<0.05 Ω)	40 °C ± 2 °C, 90% RH, Rated Load 90 minutes On, 30 minutes Off for 1000 hours -0 hour / +48 hours
Load Life (Endurance)	Values < 1 Ω: ± (3% + 0.1 Ω) Jumper: Max. 0.1 Ω after test	70 ± 2 °C, RCWV or max. working voltage whichever is less for 1000 hours with 1.5 hours "ON" and 0.5 hour "OFF"
Voltage Coefficient	± 100 (ppm/V)	1/10 rated voltage for 3 seconds max. then rated voltage for 3 seconds max.
Robustness of Termination	± (1% + 0.05 Ω)	Bend of 3 mm for 5 ± 1 seconds
Resistance to Solvent	1%: ± (0.5% + 0.05 Ω) 5%: ± (0.5% + 0.05 Ω) Jumper: Max. 0.05 Ω after test	The tested resistor should be immersed into isopropyl alcohol of 20 ~ 25 °C for 60 seconds. Then the resistor is left in the room for 48 hours.
Damp Heat with Load	1%: ± (1% + 0.05 Ω) 5%: ± (2% + 0.05 Ω) Values < 1 Ω: ± (3% + 0.1 Ω) Jumper: Max. 0.1 Ω after test	40 ± 2 °C, 90 ~ 95% R.H. RCWV or max. working voltage whichever is less for 1000 hours with 1.5 hours "ON" and 0.5 hours "OFF"

Operating Temperature Range: -55 °C to +125 °C (01005 size)
-55 °C to +155 °C (all others)

Power Derating Curve:

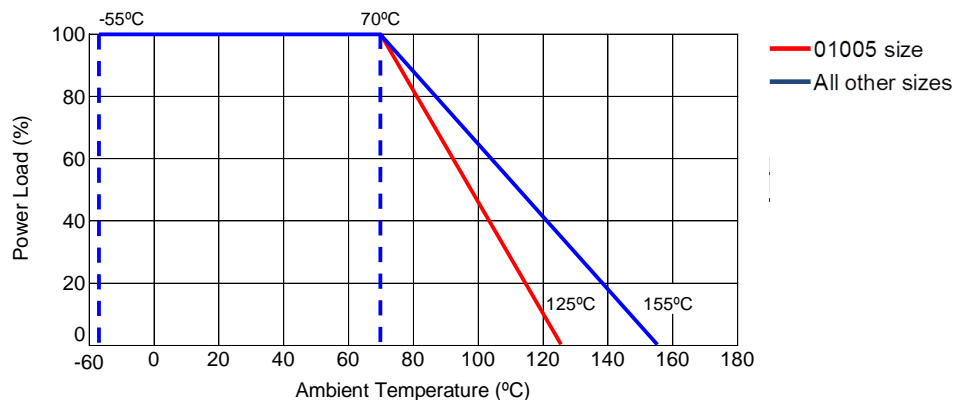

Repetitive Pulse Information

(This information is for reference only and is not guaranteed performance.)

If repetitive pulses are applied to resistors, pulse wave form must be less than “Pulse limiting voltage”, “Pulse limiting current” or “Pulse limiting wattage” calculated by the formula below.

$$\begin{aligned} V_p &= K \sqrt{P \times R \times T / t} \\ I_p &= K \sqrt{P / R \times T / t} \\ P_p &= K^2 \times P \times T / t \end{aligned}$$

Where: V_p : Pulse limiting voltage (V)
 I_p : Pulse limiting current (A)
 P_p : Pulse limiting wattage (W)
 P : Power rating (W)
 R : Nominal resistance (ohm)
 T : Repetitive period (sec)
 t : Pulse duration (sec)
 K : Coefficient by resistors type (refer to below matrix)
 $[V_r$: Rated Voltage (V), I_r : Rated Current (A)]

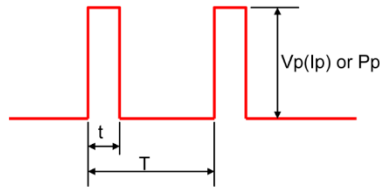

RMCF Coefficient (K) Matrix

Resistor Type	K
$R < 10 \Omega$	0.50
$10 \Omega \leq R < 100 \Omega$	0.45
$100 \Omega \leq R < 1 \text{ K } \Omega$	0.35
$1 \text{ K } \Omega \leq R < 10 \text{ K } \Omega$	0.25
$10 \text{ K } \Omega \leq R$	0.20

Waveform Transformation to Square Wave

1. Discharge curve wave with time constant “t” → Square wave

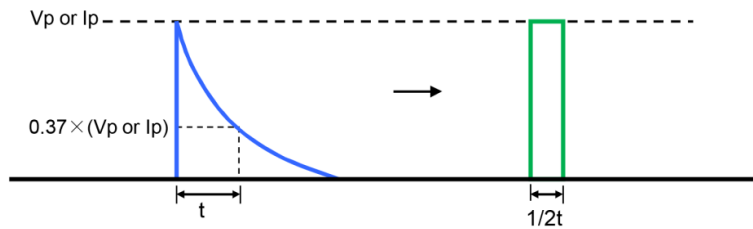

2. Damping oscillation wave with time constant of envelope “t” → Square wave

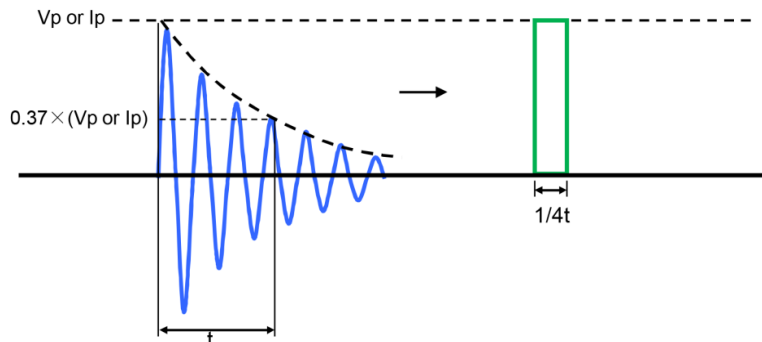

RMCF / RMCP Series

General Purpose Thick Film Standard Power and High-Power Chip Resistor

Stackpole Electronics, Inc.

Resistive Product Solutions

3. Half-wave rectification wave → Square wave

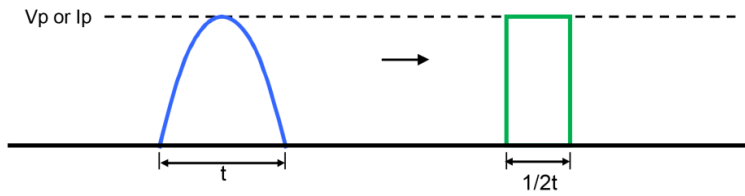

4. Triangular wave → Square wave

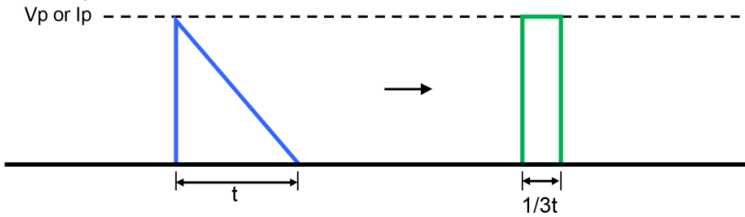

5. Special wave → Square wave

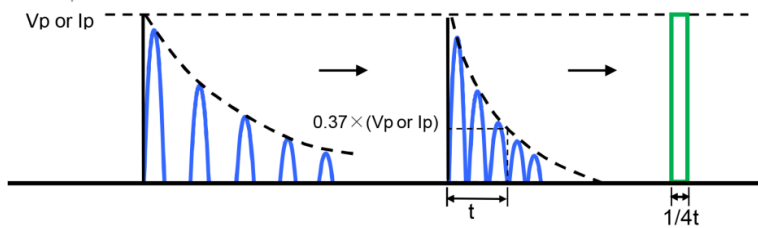

Recommended Pad Layout

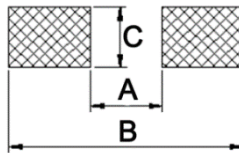

Size	A	B	C	Unit
01005	0.008	0.020	0.008	inches
	0.20	0.50	0.20	mm
0201	0.012	0.039	0.016	inches
	0.30	1.00	0.40	mm
0402	0.020	0.059	0.024	inches
	0.50	1.50	0.60	mm
0603	0.031	0.083	0.035	inches
	0.80	2.10	0.90	mm
0805	0.047	0.118	0.051	inches
	1.20	3.00	1.30	mm
1206	0.087	0.165	0.063	inches
	2.20	4.20	1.60	mm
1210	0.087	0.165	0.110	inches
	2.20	4.20	2.80	mm
2010	0.138	0.240	0.110	inches
	3.50	6.10	2.80	mm
2512	0.193	0.315	0.138	inches
	4.90	8.00	3.50	mm

RMCF / RMCP Series

General Purpose Thick Film Standard Power
and High-Power Chip Resistor

Stackpole Electronics, Inc.

Resistive Product Solutions

Packaging (EIA Standard RS-481)

Packaging Specifications

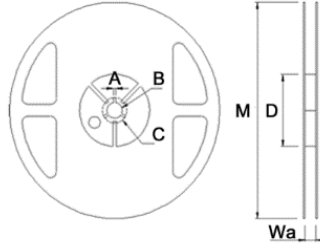

Reel Type	Wa	M	A	B	C	D	Unit
7" reel for 8 mm tape	0.354 ± 0.020	7.008 ± 0.079	0.079 ± 0.020	0.531 ± 0.020	0.827 ± 0.020	2.362 ± 0.039	inches
	9.00 ± 0.50	178.00 ± 2.00	2.00 ± 0.50	13.50 ± 0.50	21.00 ± 0.50	60.00 ± 1.00	mm
10" reel for 8 mm tape	0.394 ± 0.020	10.000 ± 0.079	0.079 ± 0.020	0.531 ± 0.020	0.827 ± 0.020	3.937 ± 0.039	inches
	10.00 ± 0.50	254.00 ± 2.00	2.00 ± 0.50	13.50 ± 0.50	21.00 ± 0.50	100.00 ± 1.00	mm

Taping Specifications - 01005, 0201, 0402

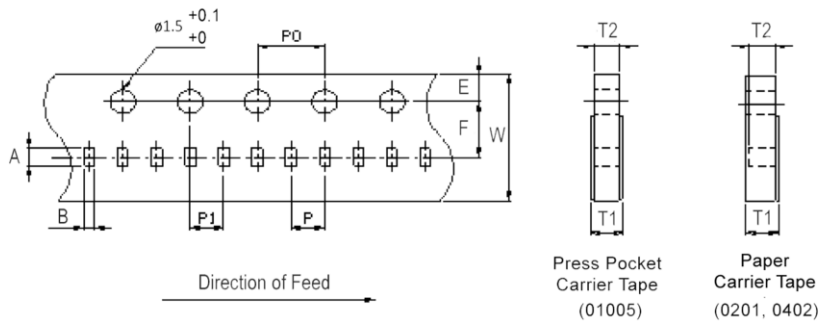

Press Pocket
Carrier Tape
(01005)

Paper
Carrier Tape
(0201, 0402)

Size	7" Reel Quantity	Typical Full Reel Weight (g)	Tape Width	A	B	W	E	F	Unit
01005	10000	127.3 ± 12.0	0.315	0.018 ± 0.001	0.010 ± 0.001	0.315 ± 0.012	0.069 ± 0.004	0.138 ± 0.002	inches
			8.00	0.45 ± 0.02	0.25 ± 0.02	8.00 ± 0.30	1.75 ± 0.10	3.50 ± 0.05	mm
0201	10000	97.2 ± 9.0	0.315	0.027 ± 0.002	0.015 ± 0.001	0.315 ± 0.004	0.069 ± 0.004	0.138 ± 0.002	inches
			8.00	0.68 ± 0.05	0.38 ± 0.03	8.00 ± 0.10	1.75 ± 0.10	3.50 ± 0.05	mm
0402	10000	94.5 ± 9.0	0.315	0.045 ± 0.002	0.026 ± 0.002	0.315 ± 0.008	0.069 ± 0.004	0.138 ± 0.002	inches
			8.00	1.15 ± 0.05	0.65 ± 0.05	8.00 ± 0.20	1.75 ± 0.10	3.50 ± 0.05	mm

Size	T1	T2	P	P0	P1	Unit
01005	0.012 ± 0.001	0.007 ± 0.001	0.079 ± 0.002	0.157 ± 0.002	0.079 ± 0.002	inches
	0.31 ± 0.03	0.17 ± 0.03	2.00 ± 0.05	4.00 ± 0.05	2.00 ± 0.05	mm
0201	0.017 ± 0.004	0.011 ± 0.001	0.079 ± 0.002	0.157 ± 0.002	0.079 ± 0.002	inches
	0.42 ± 0.10	0.28 ± 0.02	2.00 ± 0.05	4.00 ± 0.05	2.00 ± 0.05	mm
0402	0.016 ± 0.008	0.016 ± 0.002	0.079 ± 0.004	0.157 ± 0.002	0.079 ± 0.002	inches
	0.40 ± 0.20	0.40 ± 0.05	2.00 ± 0.10	4.00 ± 0.05	2.00 ± 0.05	mm

RMCF / RMCP Series

General Purpose Thick Film Standard Power
and High-Power Chip Resistor

Stackpole Electronics, Inc.

Resistive Product Solutions

Taping Specifications - 0603, 0805, 1206, 1210

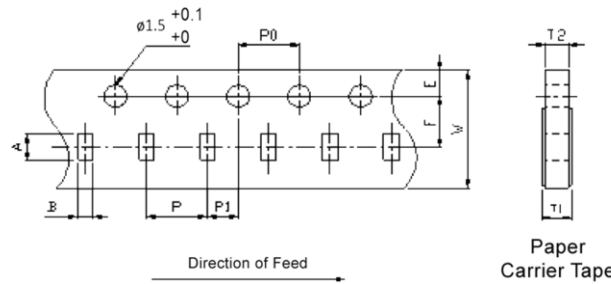

Size	7" Reel Quantity ⁽¹⁾	Typical Full Reel Weight (g)	Tape Width	A	B	W	E	F	Unit
0603	5000	118.3 ± 11.0	0.315	0.071 ± 0.004	0.039 ± 0.004	0.315 ± 0.008	0.069 ± 0.004	0.138 ± 0.002	inches
			8.00	1.80 ± 0.10	1.00 ± 0.10	8.00 ± 0.20	1.75 ± 0.10	3.50 ± 0.05	mm
0806	5000	139.2 ± 13.0	0.315	0.091 ± 0.004	0.061 ± 0.004	0.315 ± 0.008	0.069 ± 0.004	0.138 ± 0.002	inches
			8.00	2.30 ± 0.10	1.55 ± 0.10	8.00 ± 0.20	1.75 ± 0.10	3.50 ± 0.05	mm
1206	5000	151.4 ± 15.0	0.315	0.138 ± 0.008	0.075 ± 0.008	0.315 ± 0.008	0.069 ± 0.004	0.138 ± 0.002	inches
			8.00	3.50 ± 0.20	1.90 ± 0.20	8.00 ± 0.20	1.75 ± 0.10	3.50 ± 0.05	mm
1210	4000	175.7 ± 17.0	0.315	0.138 ± 0.008	0.110 ± 0.008	0.315 ± 0.008	0.069 ± 0.004	0.138 ± 0.002	inches
			8.00	3.50 ± 0.20	2.80 ± 0.20	8.00 ± 0.20	1.75 ± 0.10	3.50 ± 0.05	mm

Taping Specifications - 0603, 0805, 1206, 1210 (cont.)

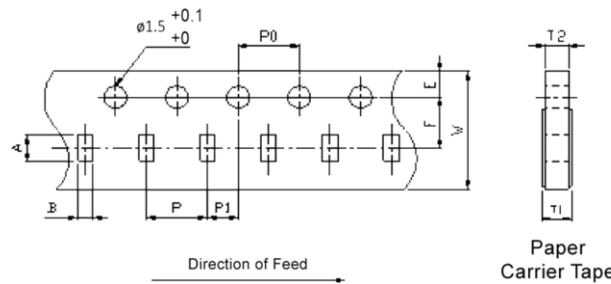

Size	T1	T2	P	P0	P1	Unit
0603	0.024 ± 0.008	0.024 ± 0.004	0.157 ± 0.004	0.157 ± 0.002	0.079 ± 0.002	inches
	0.60 ± 0.20	0.60 ± 0.10	4.00 ± 0.10	4.00 ± 0.05	2.00 ± 0.05	mm
0805	0.030 ± 0.008	0.030 ± 0.004	0.157 ± 0.004	0.157 ± 0.002	0.079 ± 0.002	inches
	0.75 ± 0.20	0.75 ± 0.10	4.00 ± 0.10	4.00 ± 0.05	2.00 ± 0.05	mm
1206	0.030 ± 0.008	0.030 ± 0.004	0.157 ± 0.004	0.157 ± 0.002	0.079 ± 0.002	inches
	0.75 ± 0.20	0.75 ± 0.10	4.00 ± 0.10	4.00 ± 0.05	2.00 ± 0.05	mm
1210	0.030 ± 0.008	0.030 ± 0.004	0.157 ± 0.004	0.157 ± 0.002	0.079 ± 0.002	inches
	0.75 ± 0.20	0.75 ± 0.10	4.00 ± 0.10	4.00 ± 0.05	2.00 ± 0.05	mm

RMCF / RMCP Series

General Purpose Thick Film Standard Power
and High-Power Chip Resistor

Stackpole Electronics, Inc.

Resistive Product Solutions

Taping Specifications (2010, 2512)

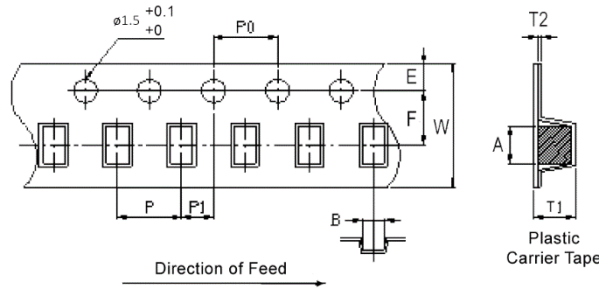

Size	7" Reel Quantity	Typical Full Reel Weight (g)	Tape Width	A	B	W	E	F	Unit
2010	4000	183.1 ± 18.0	0.472 12.00	0.217 ± 0.008 5.50 ± 0.20	0.110 ± 0.008 2.80 ± 0.20	0.472 ± 0.008 12.00 ± 0.20	0.069 ± 0.004 1.75 ± 0.10	0.217 ± 0.002 5.50 ± 0.05	inches mm
2512	4000	255.3 ± 25.0	0.472 12.00	0.264 ± 0.008 6.70 ± 0.20	0.134 ± 0.008 3.40 ± 0.20	0.472 ± 0.008 12.00 ± 0.20	0.069 ± 0.004 1.75 ± 0.10	0.217 ± 0.002 5.50 ± 0.05	inches mm

Size	T1	T2	P	P0	P1	Unit
2010	0.043 ± 0.006	0.009 ± 0.006	0.157 ± 0.004	0.157 ± 0.002	0.079 ± 0.002	inches
	1.10 ± 0.15	0.23 ± 0.15	4.00 ± 0.10	4.00 ± 0.05	2.00 ± 0.05	mm
2512	0.043 ± 0.006	0.009 ± 0.006	0.157 ± 0.004	0.157 ± 0.002	0.079 ± 0.002	inches
	1.10 ± 0.15	0.23 ± 0.15	4.00 ± 0.10	4.00 ± 0.05	2.00 ± 0.05	mm

Note: Plastic carrier tape used for 2010 and 2512 sizes.

Single Pulse Power

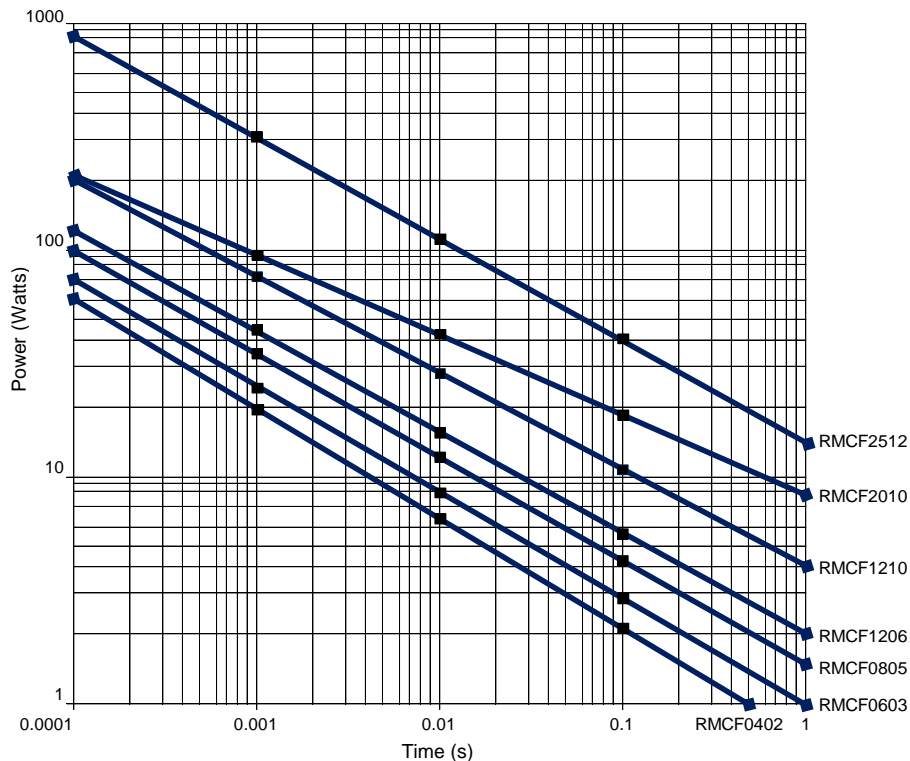

Size	Time (s)					Unit
	0.0001	0.001	0.01	0.1	1	
0402	60	18	6.3	2.2	0.7	Watts

RMCF / RMCP Series

General Purpose Thick Film Standard Power
and High-Power Chip Resistor

Stackpole Electronics, Inc.

Resistive Product Solutions

Single Pulse Power (cont.)						
Size	Time (s)					Unit
	0.0001	0.001	0.01	0.1	1	
0603	70	21.5	7.6	2.8	1	Watts
0805	94	34	12	4.4	1.6	Watts
1206	120	43	15	5.6	2	Watts
1210	240	86	31	11	4	Watts
2010	210	96	41	18	8	Watts
2512	800	300	110	42	16	Watts

The data provided are for reference only. They are typical performance for this product but are not guaranteed. The actual pulse handling of each individual resistor may vary depending on a variety of factors including resistance tolerance and resistance value. Stackpole Electronics, Inc. assumes no liability for the use of this information. Customers should validate the performance of these products in their applications. Contact Stackpole marketing to discuss specific pulse application requirements.

Temperature Measurement of Resistor Surface

Description: The resistor surface generated temperature variation after applied rated voltage.

Products and power:

Size	0201	0402	0603	0805	1206	1210	2010	2512
R-V	15 K	40.2 K	57.6 K	180 K	182 K	100 K	100 K	75 K
Rated Power	1/20 W	1/16 W	1/10 W	1/8 W	1/4 W	1/2 W	3/4 W	1 W
Maximum Rated Voltage	25 V	50 V	75 V	150 V	200 V	200 V	200 V	200 V

Test method: Measure component surface temperature directly after the temperature stabilizes.

Test result: As per table below:

Heat Rise

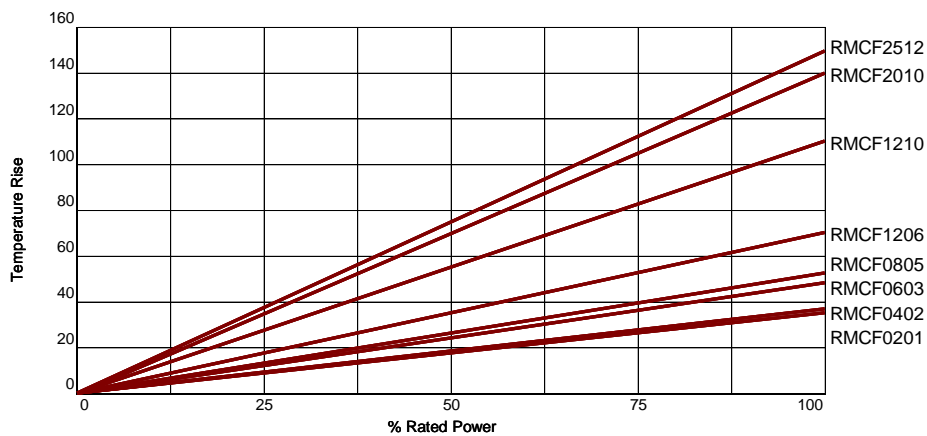

Size	0201	0402	0603	0805	1206	1210	2010	2512
Surface Temperature	36 °C	37 °C	46.2 °C	50.4 °C	70.6 °C	110.6 °C	141 °C	150.4 °C

RMCF / RMCP Series

General Purpose Thick Film Standard Power
and High-Power Chip Resistor

Stackpole Electronics, Inc.

Resistive Product Solutions

Part Marking Specifications



1% Marking

The nominal resistance is marked on the surface of the overcoating with the use of 4 digit markings.
0201 and 0402 are not marked.



5% Marking

The nominal resistance is marked on the surface of the overcoating with the use of 3 digit markings.
0201 and 0402 are not marked.

For shared E24/E96 values, 1% tolerance product may be marked with three digit marking instead of the standard four digit marking for all other E96 values. All E24 values available in 1% tolerance are also marked with three digit marking.

Mark Instructions for 0603 1% Chip Resistors (per EIA-J)

A two-digit number is assigned to each standard R-Value (E96) as shown in the chart below. This is followed by one alpha character which is used as a multiplier. Each letter "Y" – "F" represents a specific multiplier as follows:

Y = 0.1	X = 1	A = 10	B = 100
C = 1000	D(d) = 10000	E = 100000	F = 1000000

EXAMPLE:

Chip Marking	Explanation	Value
01B	01 means 10.0 and B = 100	$10.0 \times 100 = 1 \text{ K ohm}$
25C	25 means 17.8 and C = 1,000	$17.8 \times 1,000 = 17.8 \text{ K ohm}$
93D	93 means 90.9 and D = 10,000	$90.9 \times 10,000 = 909 \text{ K ohm}$

E96

1%	#	1%	#	1%	#	1%	#	1%	#	1%	#
10.0	01	14.7	17	21.5	33	31.6	49	46.4	65	68.1	81
10.2	02	15.0	18	22.1	34	32.4	50	47.5	66	69.8	82
10.5	03	15.4	19	22.6	35	33.2	51	48.7	67	71.5	83
10.7	04	15.8	20	23.2	36	34.0	52	49.9	68	73.2	84
11.0	05	16.2	21	23.7	37	34.8	53	51.1	69	75.0	85
11.3	06	16.5	22	24.3	38	35.7	54	52.3	70	76.8	86
11.5	07	16.9	23	24.9	39	36.5	55	53.6	71	78.7	87
11.8	08	17.4	24	25.5	40	37.4	56	54.9	72	80.6	88
12.1	09	17.8	25	26.1	41	38.3	57	56.2	73	82.5	89
12.4	10	18.2	26	26.7	42	39.2	58	57.6	74	84.5	90
12.7	11	18.7	27	27.4	43	40.2	59	59.0	75	86.6	91
13.0	12	19.1	28	28.0	44	41.2	60	60.4	76	88.7	92
13.3	13	19.6	29	28.7	45	42.2	61	61.9	77	90.9	93
13.7	14	20.0	30	29.4	46	43.2	62	63.4	78	93.1	94
14.0	15	20.5	31	30.1	47	44.2	63	64.9	79	95.3	95
14.3	16	21.0	32	30.9	48	45.3	64	66.5	80	97.6	96

RoHS Compliance

Stackpole Electronics has joined the worldwide effort to reduce the amount of lead in electronic components and to meet the various regulatory requirements now prevalent, such as the European Union's directive regarding "Restrictions on Hazardous Substances" (RoHS 3). As part of this ongoing program, we periodically update this document with the status regarding the availability of our compliant components. All our standard part numbers are compliant to EU Directive 2011/65/EU of the European Parliament as amended by Directive (EU) 2015/863/EU as regards the list of restricted substances.

RoHS Compliance Status						
Standard Product Series	Description	Package / Termination Type	Standard Series RoHS Compliant	Lead-Free Termination Composition	Lead-Free Mfg. Effective Date (Std Product Series)	Lead-Free Effective Date Code (YY/WW)
RMCF	General Purpose Thick Film Surface Mount Chip Resistor	SMD	YES ⁽¹⁾	100% Matte Sn over Ni	Jan-04 (Japan) Jan-05 (Taiwan, China)	04/01 05/01
RMCP	General Purpose High Power Thick Film Chip Resistor	SMD	YES ⁽¹⁾	100% Matte Sn over Ni	Always	Always

Note (1): RoHS Compliant by means of exemption 7c-I.

"Conflict Metals" Commitment

We at Stackpole Electronics, Inc. are joined with our industry in opposing the use of metals mined in the "conflict region" of the eastern Democratic Republic of the Congo (DRC) in our products. Recognizing that the supply chain for metals used in the electronics industry is very complex, we work closely with our own suppliers to verify to the extent possible that the materials and products we supply do not contain metals sourced from this conflict region. As such, we are in compliance with the requirements of Dodd-Frank Act regarding Conflict Minerals.

Compliance to "REACH"

We certify that all passive components supplied by Stackpole Electronics, Inc. are SVHC (Substances of Very High Concern) free and compliant with the requirements of EU Directive 1907/2006/EC, "The Registration, Evaluation, Authorization and Restriction of Chemicals", otherwise referred to as REACH. Contact us for complete list of REACH Substance Candidate List.

Environmental Policy

It is the policy of Stackpole Electronics, Inc. (SEI) to protect the environment in all localities in which we operate. We continually strive to improve our effect on the environment. We observe all applicable laws and regulations regarding the protection of our environment and all requests related to the environment to which we have agreed. We are committed to the prevention of all forms of pollution.

RMCF / RMCP Series

General Purpose Thick Film Standard Power and High-Power Chip Resistor

Stackpole Electronics, Inc.

Resistive Product Solutions

How to Order - RMCF

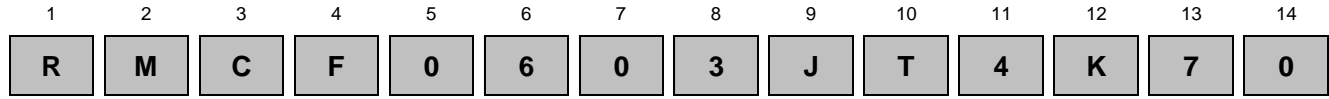

Product Series		Size		Tolerance			Packaging				Resistance Value
Code	Description	Size	Power Rating	Code	Tol	Value	Code	Description	Size	Quantity	
RMCF	Thick Film Chip Resistors	01005	0.03 W	F	1%	E96, E24	T	7" Reel - Paper Tape	01005	10000	Four characters with the multiplier used as the decimal holder. 0.1 ohm = R100 4.70 ohm = 4R70 10.0 Kohm = 10K0 1 Mohm = 1M00 Zero ohm jumper = 0R00
		0201	0.05 W	J	5%	E24			0201, 0402	10000	
		0402	0.063 W	Z	Jumper				0603, 0805, 1206	5000	
		0603	0.1 W						1210	4000	
		0805	0.125 W						2010, 2512	4000	
		1206	0.25 W				G	10" Reel - Paper Tape	0603, 0805, 1206	10000	
		1210	0.33 W(*)								
		2010	0.75 W								
		2512	1 W								

(*) Power rating is 0.5 W for ohmic values below 1 K Ω

How to Order - RMCP

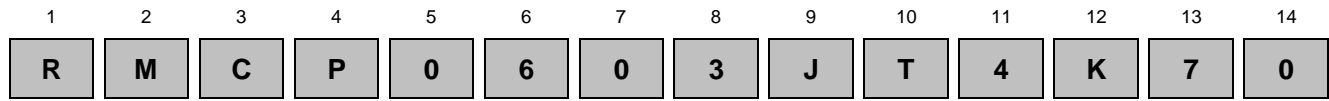

Product Series		Size		Tolerance			Packaging				Resistance Value
Code	Description	Size	Power Rating	Code	Tol	Value	Code	Description	Size	Quantity	
RMCP	High Power	0201	0.063 W	F	1%	E96, E24	T	7" Reel Paper Tape	0201, 0402	10000	Four characters with the multiplier used as the decimal 1 ohm = 1R00 10 Kohm = 10K0 1 Mohm = 1M00
		0402	0.125 W	J	5%	E24			0603, 0805	5000	
		0603	0.25 W	Z	Jumper				1206, 1210	4000	
		0805	0.33 W						2010, 2512	4000	
		1206	0.33 W						G	10" Reel Paper Tape	
		1210	0.5 W				1206, 1210	8000			
		2010	1 W								
		2512	2 W								