

Chip beads  
For general signal line  
MMZ series



# MMZ1608 type



## FEATURES

- Noise reduction solution for general signal line.
- Various frequency characteristics with 8 materials of different features for countermeasures against everything from general signals to high-speed signals.
- Operating temperature range: -55 to +125°C

## APPLICATION

- Noise removal for mobile devices such as smartphones and tablet terminals, and various modules.
- Noise removal for PCs and recorders, household appliances such as STBs, smart grids, and industrial equipment.

## PART NUMBER CONSTRUCTION

MMZ	1608	S	121	A	T	A00
Series name	LxWxT dimensions 1.6x0.8x0.6 mm 1.6x0.8x0.8 mm	Material name	Impedance ( $\Omega$ ) at 100MHz	Characteristic type	Packaging style	Internal code

## CHARACTERISTICS SPECIFICATION TABLE

Impedance [100MHz] ( $\Omega$ )	DC resistance ( $\Omega$ )max.	Rated current (mA)max.	Thickness T (mm)	Part No.	
120	$\pm 25\%$	0.15	600	0.6	<a href="#">MMZ1608B121CTAH0</a>
220	$\pm 25\%$	0.25	500	0.6	<a href="#">MMZ1608B221CTAH0</a>
300	$\pm 25\%$	0.25	500	0.6	<a href="#">MMZ1608B301CTAH0</a>
470	$\pm 25\%$	0.30	500	0.6	<a href="#">MMZ1608B471CTAH0</a>
600	$\pm 25\%$	0.40	500	0.6	<a href="#">MMZ1608B601CTAH0</a>
1000	$\pm 25\%$	0.60	300	0.8	<a href="#">MMZ1608B102CTA00</a>
15	$\pm 25\%$	0.05	1500	0.8	<a href="#">MMZ1608R150ATA00</a>
30	$\pm 25\%$	0.05	1500	0.8	<a href="#">MMZ1608R300ATA00</a>
60	$\pm 25\%$	0.10	800	0.8	<a href="#">MMZ1608R600ATA00</a>
120	$\pm 25\%$	0.18	500	0.8	<a href="#">MMZ1608R121ATA00</a>
300	$\pm 25\%$	0.25	500	0.8	<a href="#">MMZ1608R301ATA00</a>
470	$\pm 25\%$	0.30	500	0.8	<a href="#">MMZ1608R471ATA00</a>
600	$\pm 25\%$	0.40	500	0.8	<a href="#">MMZ1608R601ATA00</a>
1000	$\pm 25\%$	0.50	400	0.8	<a href="#">MMZ1608R102ATA00</a>

### Measurement equipment

Measurement item	Product No.	Manufacturer
Impedance	E4991A+16192A	Keysight Technologies
DC resistance	Type-7556	Yokogawa

\* Equivalent measurement equipment may be used.

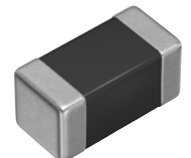

# MMZ1608 type

## CHARACTERISTICS SPECIFICATION TABLE

Impedance [100MHz] ( $\Omega$ )		DC resistance ( $\Omega$ )max.	Rated current (mA)max.	Thickness T (mm)	Part No.
	Tolerance				
40	±25%	0.10	600	0.8	<a href="#">MMZ1608S400ATA00</a>
80	±25%	0.15	500	0.8	<a href="#">MMZ1608S800ATA00</a>
120	±25%	0.15	500	0.8	<a href="#">MMZ1608S121ATA00</a>
180	±25%	0.20	500	0.8	<a href="#">MMZ1608S181ATA00</a>
220	±25%	0.20	500	0.8	<a href="#">MMZ1608S221ATA00</a>
300	±25%	0.30	500	0.8	<a href="#">MMZ1608S301ATA00</a>
470	±25%	0.30	500	0.8	<a href="#">MMZ1608S471ATA00</a>
600	±25%	0.35	500	0.8	<a href="#">MMZ1608S601ATA00</a>
1000	±25%	0.50	400	0.8	<a href="#">MMZ1608S102ATA00</a>
2000	±25%	0.90	200	0.8	<a href="#">MMZ1608S202ATA00</a>
15	±25%	0.05	1500	0.8	<a href="#">MMZ1608Y150BTA00</a>
30	±25%	0.05	1500	0.8	<a href="#">MMZ1608Y300BTA00</a>
60	±25%	0.15	500	0.8	<a href="#">MMZ1608Y600BTA00</a>
120	±25%	0.20	500	0.8	<a href="#">MMZ1608Y121BTA00</a>
220	±25%	0.30	500	0.8	<a href="#">MMZ1608Y221BTA00</a>
300	±25%	0.30	500	0.8	<a href="#">MMZ1608Y301BTA00</a>
470	±25%	0.35	500	0.8	<a href="#">MMZ1608Y471BTA00</a>
600	±25%	0.40	500	0.8	<a href="#">MMZ1608Y601BTA00</a>
750	±25%	0.45	500	0.8	<a href="#">MMZ1608Y751BTA00</a>
1000	±25%	0.50	400	0.8	<a href="#">MMZ1608Y102BTA00</a>
1500	±25%	0.60	300	0.8	<a href="#">MMZ1608Y152BTA00</a>
1800	±25%	0.80	200	0.8	<a href="#">MMZ1608A182BTA00</a>
2200	±25%	0.80	200	0.8	<a href="#">MMZ1608A222BTA00</a>
2500	±25%	0.80	200	0.8	<a href="#">MMZ1608A252BTA00</a>
120	±25%	0.30	500	0.8	<a href="#">MMZ1608Q121BTA00</a>
220	±25%	0.40	500	0.8	<a href="#">MMZ1608Q221BTA00</a>
330	±25%	0.50	400	0.8	<a href="#">MMZ1608Q331BTA00</a>
470	±25%	0.70	300	0.8	<a href="#">MMZ1608Q471BTA00</a>
600	±25%	0.80	200	0.8	<a href="#">MMZ1608Q601BTA00</a>
1000	±25%	1.00	200	0.8	<a href="#">MMZ1608Q102BTA00</a>
5	±2 $\Omega$	0.05	700	0.8	<a href="#">MMZ1608D050CTA00</a>
10	±5 $\Omega$	0.10	500	0.6	<a href="#">MMZ1608D100CTA00</a>
22	±25%	0.20	500	0.6	<a href="#">MMZ1608D220CTA00</a>
50	±25%	0.25	500	0.6	<a href="#">MMZ1608D500CTA00</a>
80	±25%	0.30	500	0.6	<a href="#">MMZ1608D800CTA00</a>
80	±25%	0.30	500	0.8	<a href="#">MMZ1608D800BTA00</a>
120	±25%	0.30	400	0.6	<a href="#">MMZ1608D121CTA00</a>
120	±25%	0.30	400	0.8	<a href="#">MMZ1608D121BTA00</a>
240	±25%	0.60	300	0.8	<a href="#">MMZ1608D241CTA00</a>
300	±25%	0.70	300	0.8	<a href="#">MMZ1608D301BTA00</a>
3typ.		0.05	700	0.8	<a href="#">MMZ1608F030BTA00</a>
47	±25%	0.40	500	0.8	<a href="#">MMZ1608F470BTA00</a>
75	±25%	0.55	300	0.8	<a href="#">MMZ1608F750BTA00</a>
120	±25%	0.75	200	0.8	<a href="#">MMZ1608F121BTA00</a>

### Measurement equipment

Measurement item	Product No.	Manufacturer
Impedance	E4991A+16192A	Keysight Technologies
DC resistance	Type-7556	Yokogawa

\* Equivalent measurement equipment may be used.

# MMZ1608 type

## Z VS. FREQUENCY CHARACTERISTICS (BY SERIES)

**MMZ1608B series**

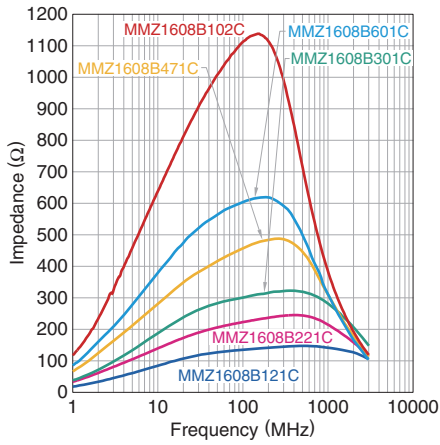

**MMZ1608R series**

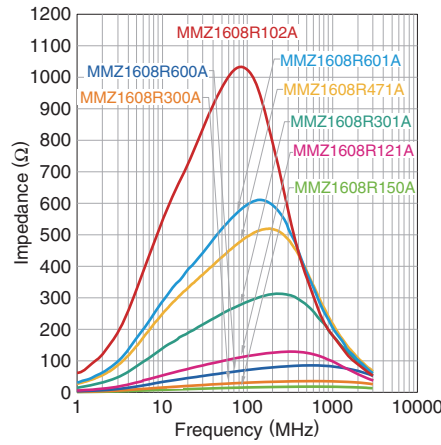

**MMZ1608S series**

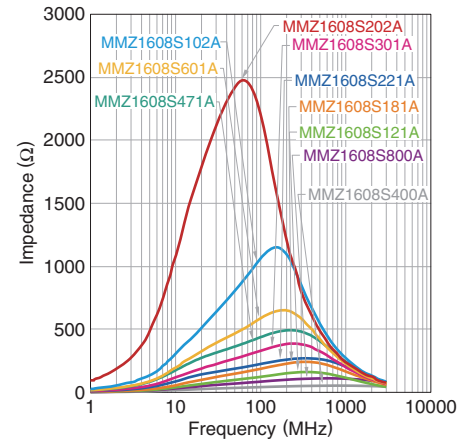

**MMZ1608Y series**

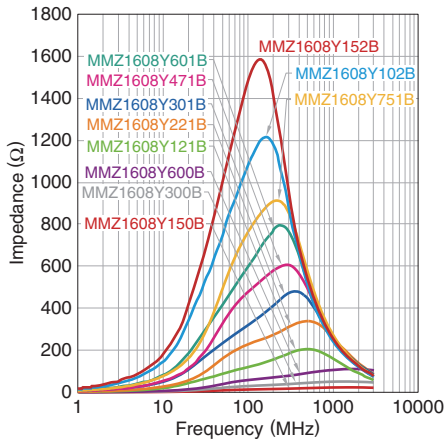

**MMZ1608A series**

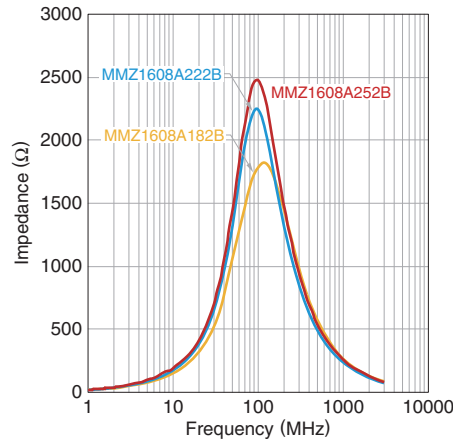

**MMZ1608Q series**

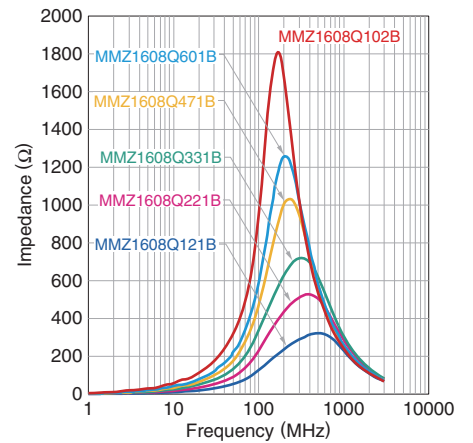

**MMZ1608D series**

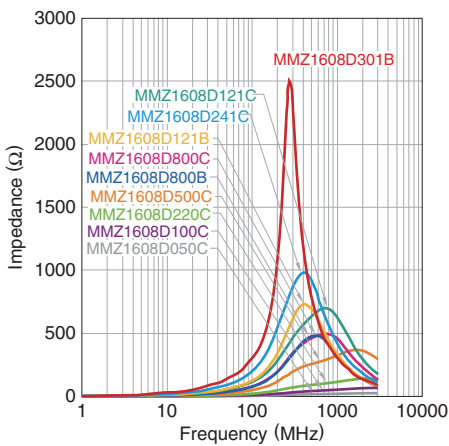

**MMZ1608F series**

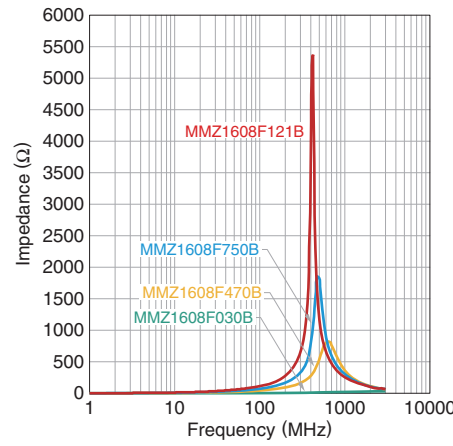

⚠ Please be sure to request delivery specifications that provide further details on the features and specifications of the products for proper and safe use. Please note that the contents may change without any prior notice due to reasons such as upgrading.

# MMZ1608 type

## Z, X, R VS. FREQUENCY CHARACTERISTICS

MMZ1608B121CTAH0

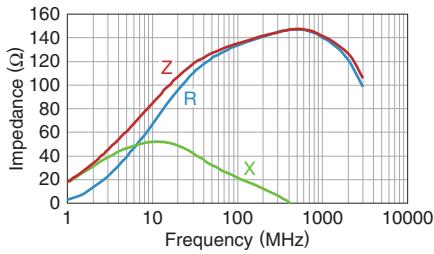

MMZ1608B221CTAH0

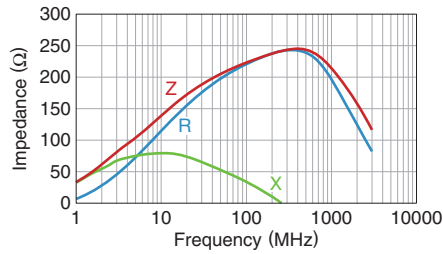

MMZ1608B301CTAH0

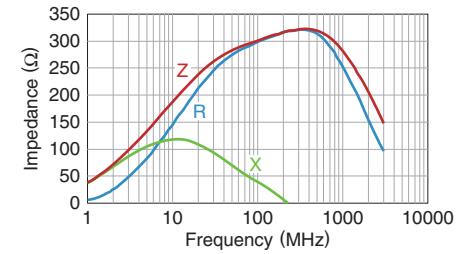

MMZ1608B471CTAH0

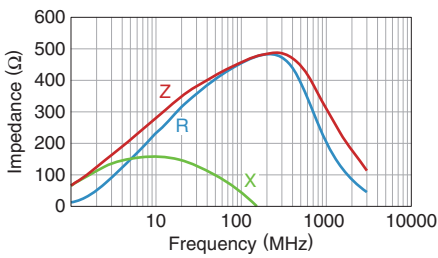

MMZ1608B601CTAH0

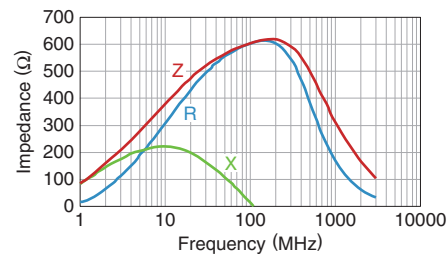

MMZ1608B102CTA00

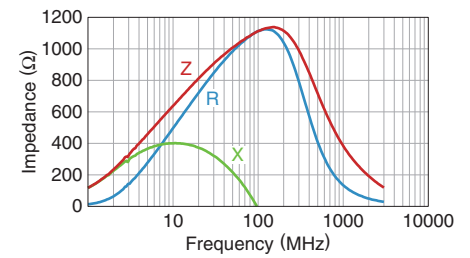

MMZ1608R150ATA00

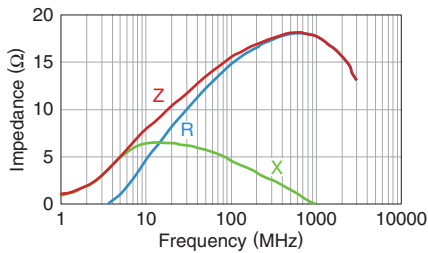

MMZ1608R300ATA00

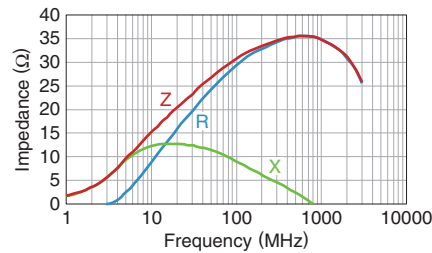

MMZ1608R600ATA00

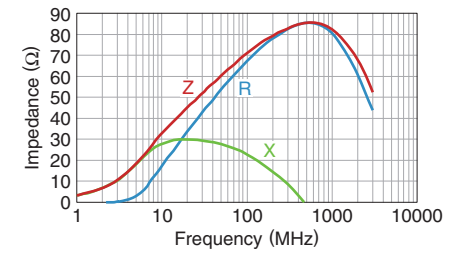

MMZ1608R121ATA00

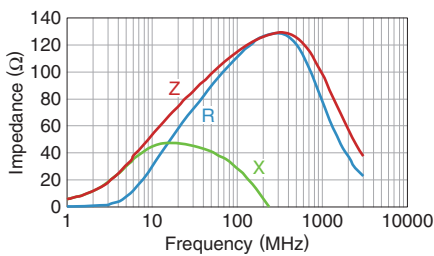

MMZ1608R301ATA00

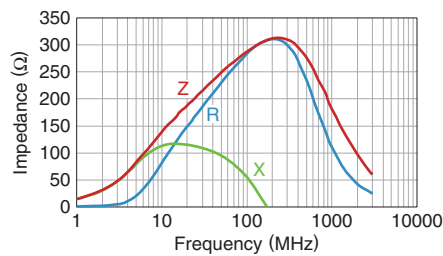

MMZ1608R471ATA00

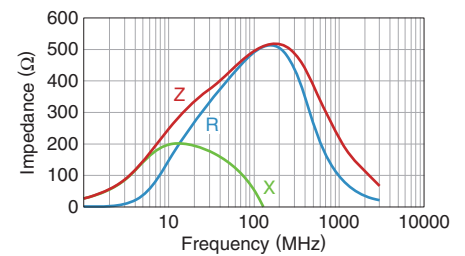

MMZ1608R601ATA00

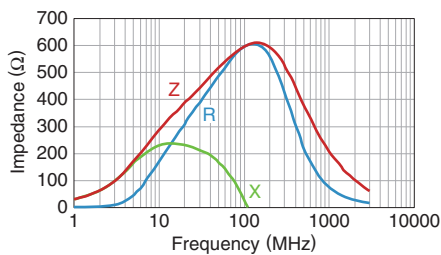

MMZ1608R102ATA00

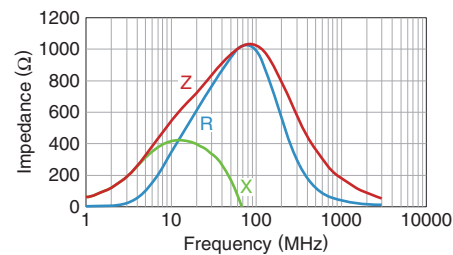

MMZ1608S400ATA00

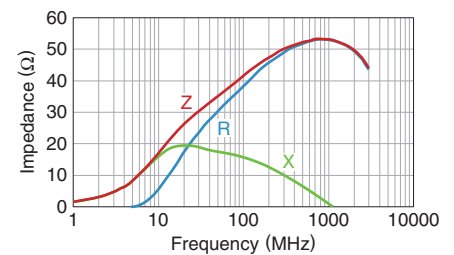

⚠ Please be sure to request delivery specifications that provide further details on the features and specifications of the products for proper and safe use. (4/9)  
Please note that the contents may change without any prior notice due to reasons such as upgrading.

20200717

beads\_commercial\_signal\_mmz1608\_en

# MMZ1608 type

## Z, X, R VS. FREQUENCY CHARACTERISTICS

MMZ1608S800ATA00

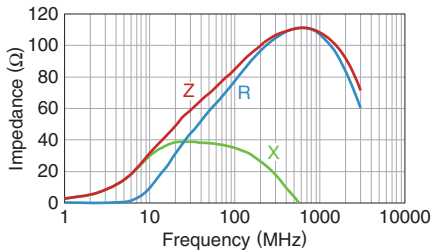

MMZ1608S121ATA00

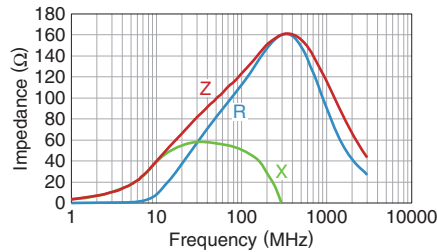

MMZ1608S181ATA00

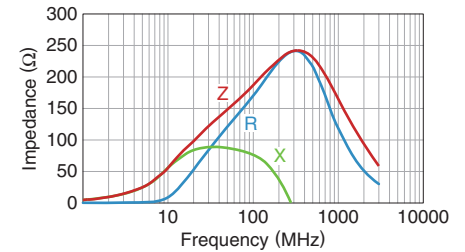

MMZ1608S221ATA00

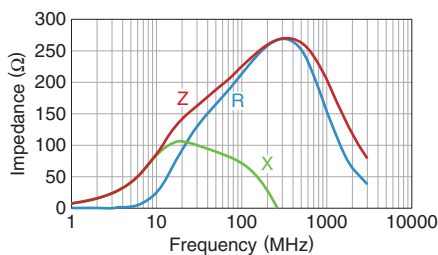

MMZ1608S301ATA00

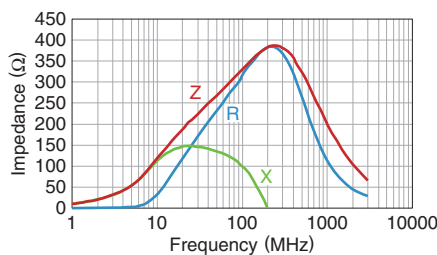

MMZ1608S471ATA00

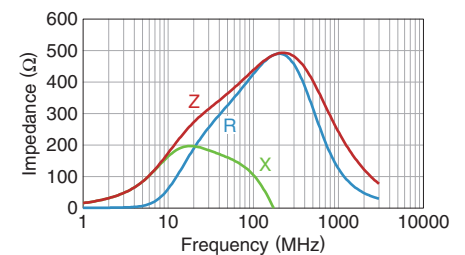

MMZ1608S601ATA00

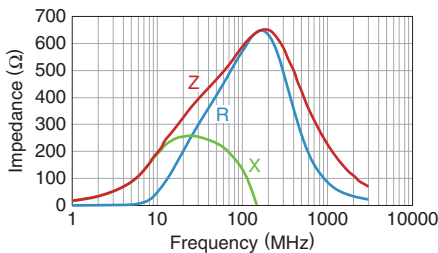

MMZ1608S102ATA00

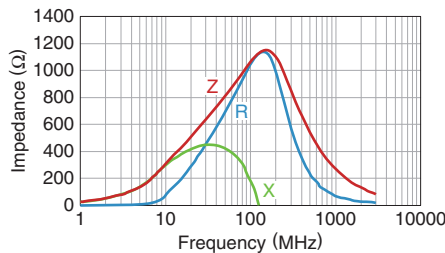

MMZ1608S202ATA00

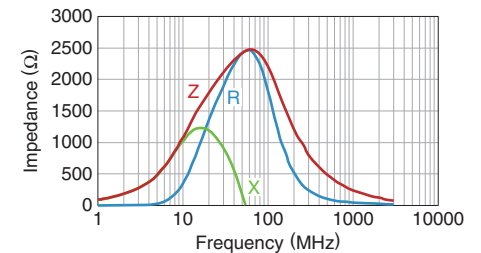

MMZ1608Y150BTA00

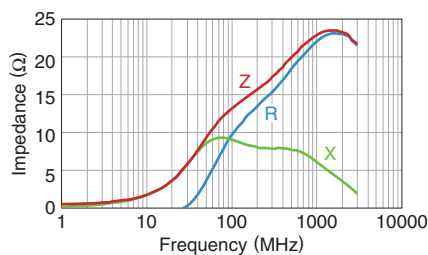

MMZ1608Y300BTA00

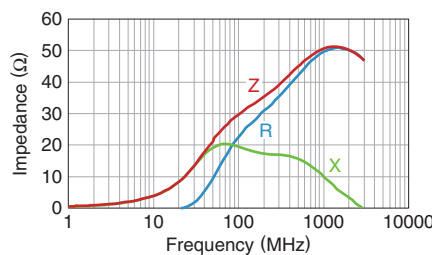

MMZ1608Y600BTA00

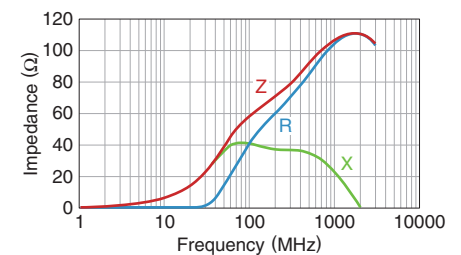

MMZ1608Y121BTA00

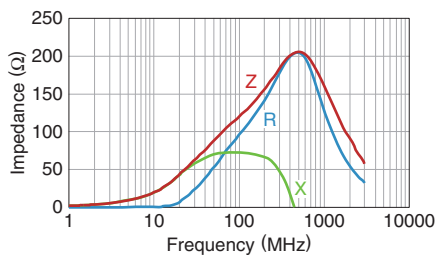

MMZ1608Y221BTA00

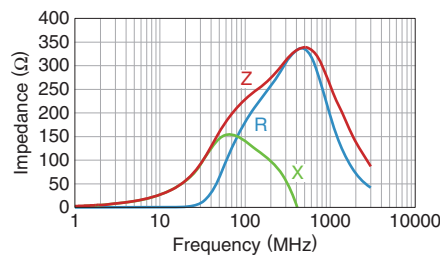

MMZ1608Y301BTA00

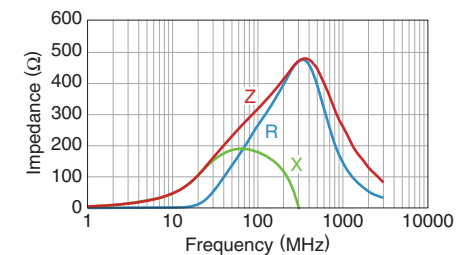

⚠ Please be sure to request delivery specifications that provide further details on the features and specifications of the products for proper and safe use. (5/9)  
Please note that the contents may change without any prior notice due to reasons such as upgrading.

20200717

beads\_commercial\_signal\_mmz1608\_en

# MMZ1608 type

## Z, X, R VS. FREQUENCY CHARACTERISTICS

MMZ1608Y471BTA00

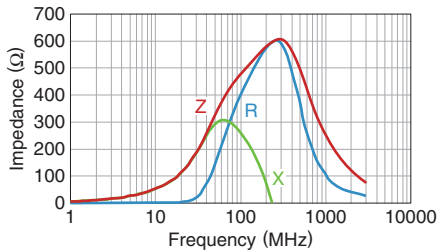

MMZ1608Y601BTA00

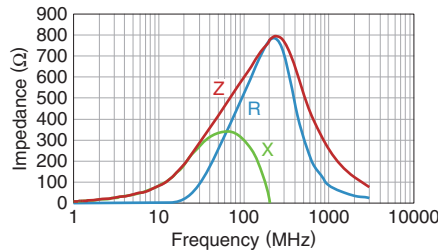

MMZ1608Y751BTA00

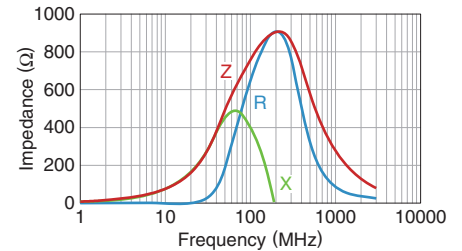

MMZ1608Y102BTA00

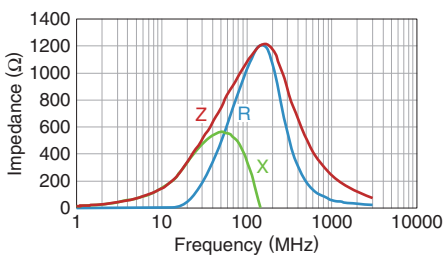

MMZ1608Y152BTA00

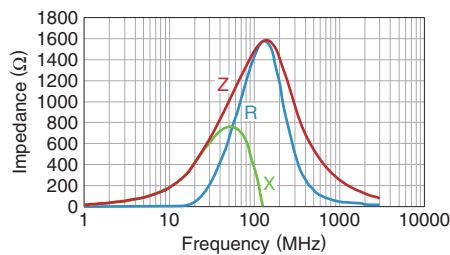

MMZ1608A182BTA00

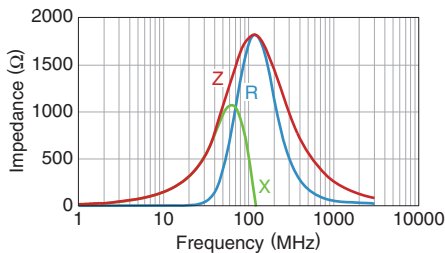

MMZ1608A222BTA00

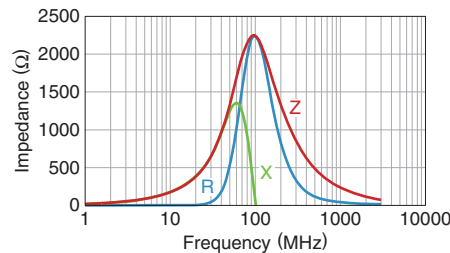

MMZ1608A252BTA00

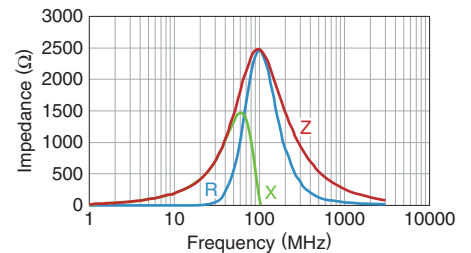

MMZ1608Q121BTA00

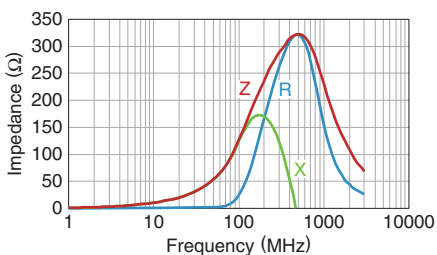

MMZ1608Q221BTA00

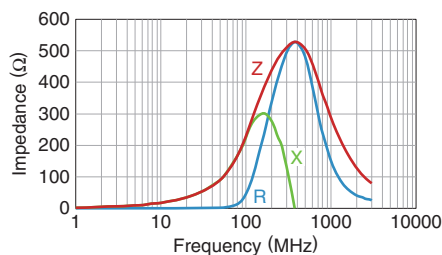

MMZ1608Q331BTA00

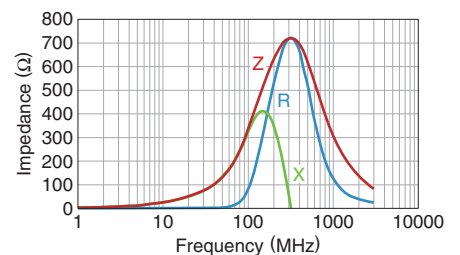

MMZ1608Q471BTA00

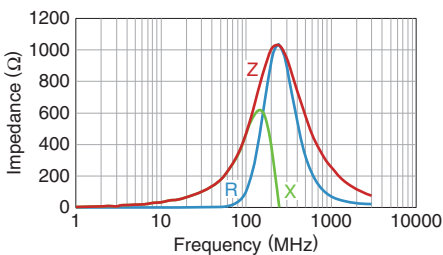

MMZ1608Q601BTA00

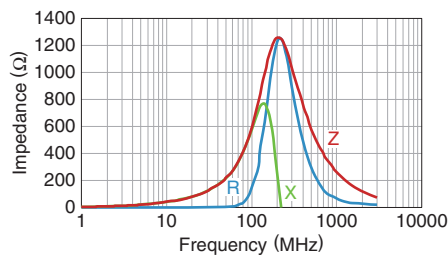

MMZ1608Q102BTA00

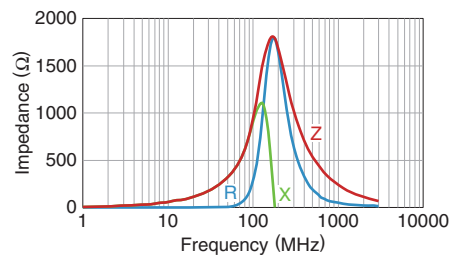

⚠ Please be sure to request delivery specifications that provide further details on the features and specifications of the products for proper and safe use. (6/9)  
Please note that the contents may change without any prior notice due to reasons such as upgrading.

20200717

beads\_commercial\_signal\_mmz1608\_en

# MMZ1608 type

## Z, X, R VS. FREQUENCY CHARACTERISTICS

**MMZ1608D050CTA00**

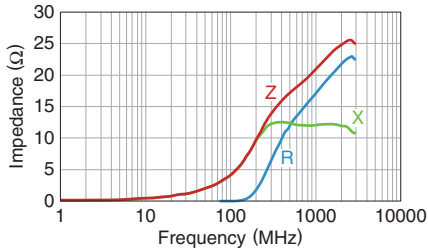

**MMZ1608D100CTA00**

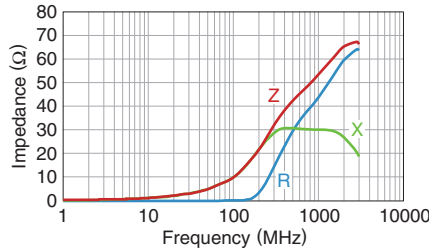

**MMZ1608D220CTA00**

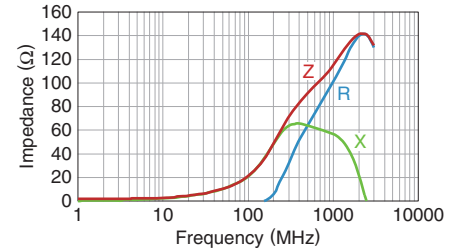

**MMZ1608D500CTA00**

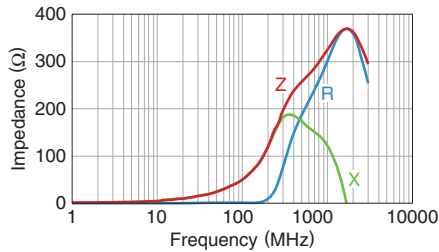

**MMZ1608D800CTA00**

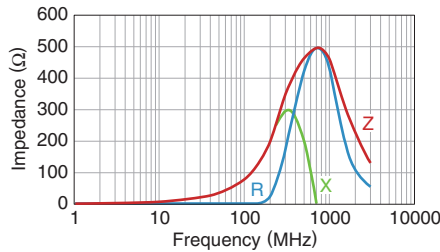

**MMZ1608D800BTA00**

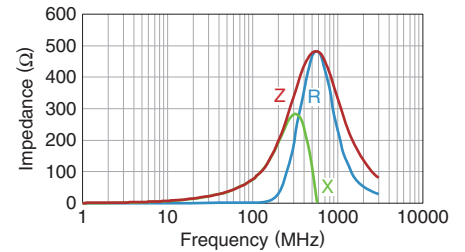

**MMZ1608D121CTA00**

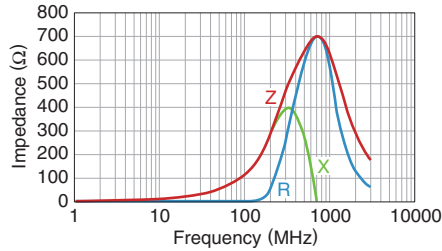

**MMZ1608D121BTA00**

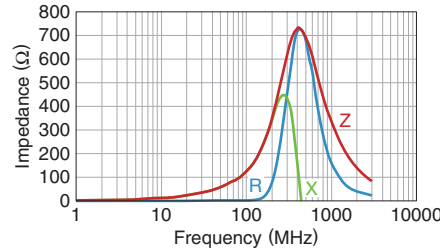

**MMZ1608D241CTA00**

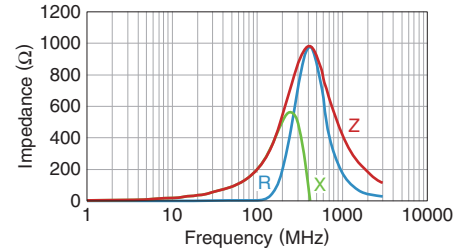

**MMZ1608D301BTA00**

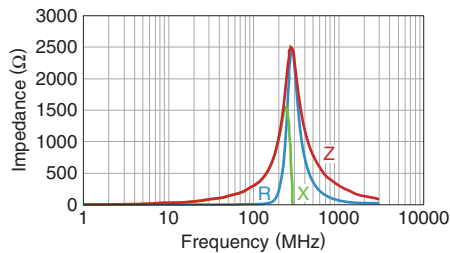

**MMZ1608F030BTA00**

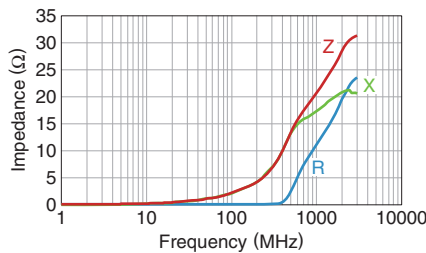

**MMZ1608F470BTA00**

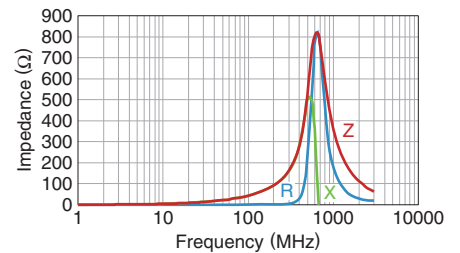

**MMZ1608F750BTA00**

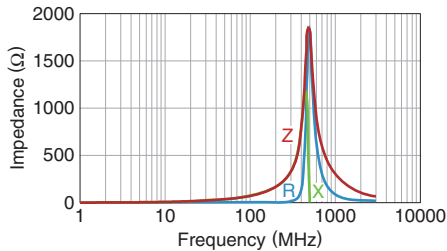

**MMZ1608F121BTA00**

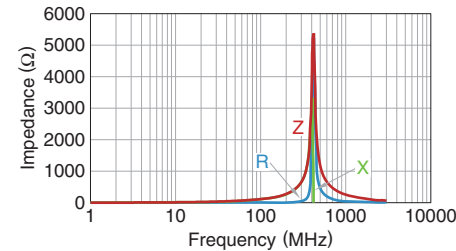

# MMZ1608 type

## SHAPE & DIMENSIONS

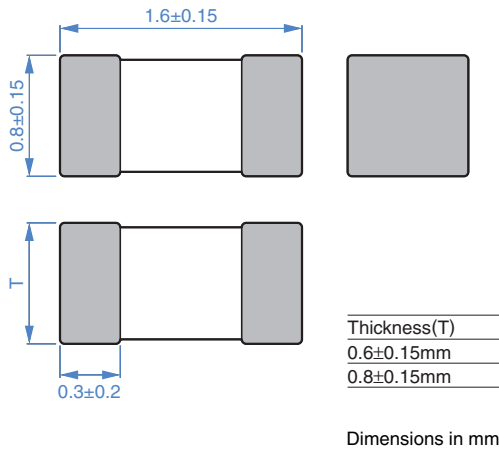

## PACKAGING STYLE

### REEL DIMENSIONS

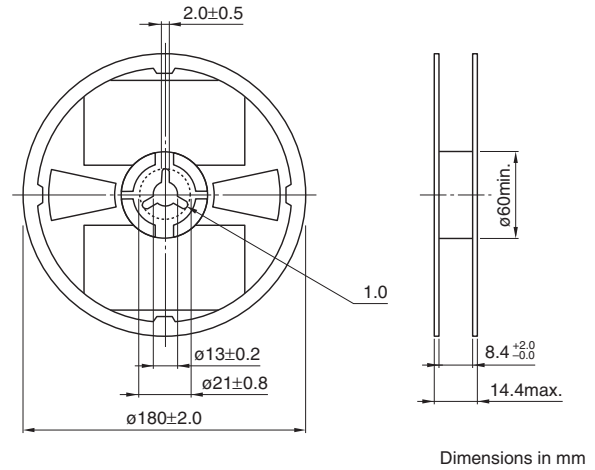

## RECOMMENDED LAND PATTERN

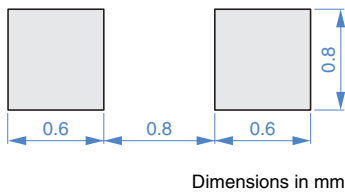

### TAPE DIMENSIONS

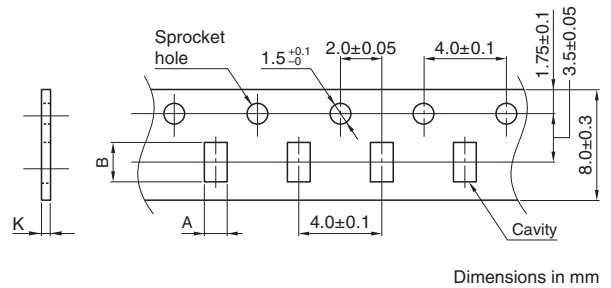

## RECOMMENDED REFLOW PROFILE

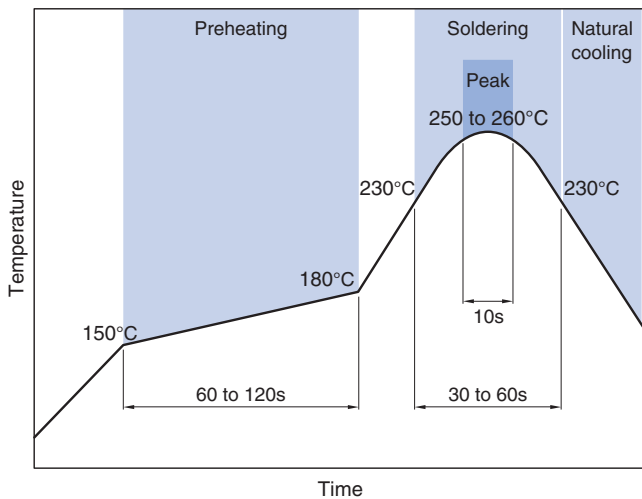

Type	A	B	K
MMZ1608	1.1±0.2	1.9±0.2	1.1max.

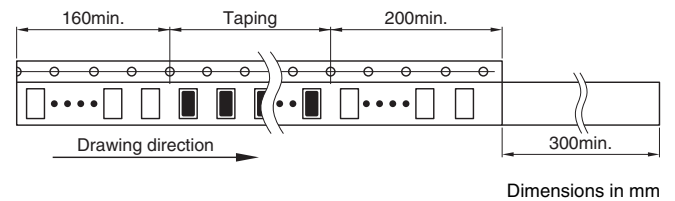

### PACKAGE QUANTITY

Package quantity	4,000 pcs/reel
------------------	----------------

## TEMPERATURE RANGE, INDIVIDUAL WEIGHT

Type	Operating temperature range	Storage temperature range*	Individual weight
t=0.6mm	-55 to +125°C	-55 to +125°C	3 mg
t=0.8mm	-55 to +125°C	-55 to +125°C	4 mg

\* The storage temperature range is for after the assembly.



## REMINDERS FOR USING THESE PRODUCTS

Before using these products, be sure to request the delivery specifications.

### SAFETY REMINDERS

Please pay sufficient attention to the warnings for safe designing when using this products.

#### REMINDERS

- The storage period is within 12 months. Be sure to follow the storage conditions (temperature: 5 to 40°C, humidity: 10 to 75% RH or less).  
If the storage period elapses, the soldering of the terminal electrodes may deteriorate.
- Do not use or store in locations where there are conditions such as gas corrosion (salt, acid, alkali, etc.).
- Before soldering, be sure to preheat components.  
The preheating temperature should be set so that the temperature difference between the solder temperature and chip temperature does not exceed 150°C.
- Soldering corrections after mounting should be within the range of the conditions determined in the specifications.  
If overheated, a short circuit, performance deterioration, or lifespan shortening may occur.
- When embedding a printed circuit board where a chip is mounted to a set, be sure that residual stress is not given to the chip due to the overall distortion of the printed circuit board and partial distortion such as at screw tightening portions.
- Self heating (temperature increase) occurs when the power is turned ON, so the tolerance should be sufficient for the set thermal design.
- Carefully lay out the coil for the circuit board design of the non-magnetic shield type.  
A malfunction may occur due to magnetic interference.
- Use a wrist band to discharge static electricity in your body through the grounding wire.
- Do not expose the products to magnets or magnetic fields.
- Do not use for a purpose outside of the contents regulated in the delivery specifications.
- The products listed on this catalog are intended for use in general electronic equipment (AV equipment, telecommunications equipment, home appliances, amusement equipment, computer equipment, personal equipment, office equipment, measurement equipment, industrial robots) under a normal operation and use condition.  
The products are not designed or warranted to meet the requirements of the applications listed below, whose performance and/or quality require a more stringent level of safety or reliability, or whose failure, malfunction or trouble could cause serious damage to society, person or property.  
If you intend to use the products in the applications listed below or if you have special requirements exceeding the range or conditions set forth in the each catalog, please contact us.

- (1) Aerospace/aviation equipment
- (2) Transportation equipment (cars, electric trains, ships, etc.)
- (3) Medical equipment
- (4) Power-generation control equipment
- (5) Atomic energy-related equipment
- (6) Seabed equipment
- (7) Transportation control equipment

- (8) Public information-processing equipment
- (9) Military equipment
- (10) Electric heating apparatus, burning equipment
- (11) Disaster prevention/crime prevention equipment
- (12) Safety equipment
- (13) Other applications that are not considered general-purpose applications

When designing your equipment even for general-purpose applications, you are kindly requested to take into consideration securing protection circuit/device or providing backup circuits in your equipment.