

## Chip Coil (Chip Inductors) DFE2HCAH□□□J0L REFERENCE SPECIFICATION

### Murata Standard Specification [AEC-Q200]

### 1.Scope

This reference specification applies to DFE2HCAH□□□J0L, Chip Coil (Chip Inductors) for Automotive Electronic based on AEC-Q200.

### 2.Part Numbering

(ex)	DF	E	2H	CA	H	1R0	M	J	0	L
	Product ID	Structure	Dimension (L×W)	Applications and Characteristics	Category	Inductance	Tolerance	Dimension (T)	Other	Packaging

### 3.Rating

- Operating Temperature Range  
 (Ambient temperature; Self-temperature rise is not included)      -40 to +110°C  
 (Product temperature; Self-temperature rise is included)      -40 to +150°C
- Storage Temperature Range.      -40 to +110°C
- It can be considered for use with DCDC converters with a maximum voltage of 40 V or less.

Customer Part Number	Murata Part Number	Inductance		DC Resistance Max. (Ω)	*3 Rated Current (A)		ESD Level (HBM)
		(μH)	Tolerance (%)		*1 Based on Inductance change	*2 Based on Temperature rise	
	DFE2HCAHR33MJ0L	0.33	±20	0.021	5.8	4.9	1kV
	DFE2HCAHR47MJ0L	0.47		0.025	5.1	4.5	
	DFE2HCAHR68MJ0L	0.68		0.031	4.4	3.6	
	DFE2HCAH1R0MJ0L	1.0		0.050	3.4	3.0	
	DFE2HCAH1R5MJ0L	1.5		0.074	2.9	2.3	
	DFE2HCAH2R2MJ0L	2.2		0.101	2.5	1.9	

- \*1: The saturation allowable DC current value is specified when the decrease of the initial Inductance value at 30%.  
 \*2: Rated current (Based on Temperature rise) is the current value at which the product temperature rises to 40°C when direct current is applied to the inductor with the product mounted on our designated board.  
 \*3: Value defined when DC current flows and Rated Current (Based on Inductance change) or when DC current flows and Rated Current (Based on Temperature rise) whichever is smaller.

### 4. Testing Conditions (Standard atmospheric conditions)

<Unless otherwise specified>

Temperature : Ordinary Temperature (15 to 35°C)  
 Humidity : Ordinary Humidity (25 to 85% (RH))

<In case of doubt>

Temperature : 20 ± 2°C  
 Humidity : 65±5% (RH)  
 Atmospheric Pressure : 86 to 106 kPa

### 5.Appearance and Dimensions

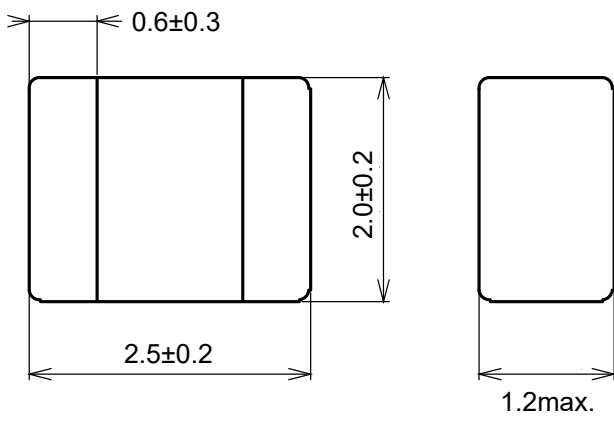

■ Unit Mass (Typical value) 0.0324g

⊗ no marking

## 6. Electrical Performance

No.	No.	Item	Specification
6.1	Inductance	Meet item 3	Measuring Equipment: KEYSIGHT 4284A or equivalent (0.5V) Measuring Frequency: 1MHz
6.2	DC Resistance		Measuring Equipment: Resistance Hitester 3541(HIOKI) or equivalent
6.3	Withstand voltage	Inductance : Meet item 3	machine: impulse testing machine applied voltage: 60-70V

## 7. Q200 Requirement

### AEC-Q200 Rev.D issued June 1. 2010

AEC-Q200			Murata Specification / Deviation				
No.	Stress	Test Method					
3	High Temperature Exposure	1000±12h at 150±2 deg C Set for 24±2hours at room temperature, then measured.	Meet Table A after testing. <u>Table A</u> <table border="1" style="margin-left: 20px;"> <tr> <td>Appearance</td> <td>No damage</td> </tr> <tr> <td>Inductance Change from an initial value</td> <td>within ± 10%</td> </tr> </table>	Appearance	No damage	Inductance Change from an initial value	within ± 10%
Appearance	No damage						
Inductance Change from an initial value	within ± 10%						
4	Temperature Cycling	1000cycles -40 deg C for 30 min and 150 deg C for 30 min with the transit period of 2min or less Measured within 24±2hours at room temperature.					
7	Biased Humidity	1000±12h at 85±2 deg C, 85%RH Measured within 24±2hours at room temperature.					
8	Operational Life	Apply 110±2 deg C 1000±12h Measured within 24±2h at room temperature.					
10	Physical Dimension	Measures using digital slide calipers and an optical microscope.	According to specification				

# Reference Only

AEC-Q200			Murata Specification / Deviation
No.	Stress	Test Method	
13	Mechanical Shock	Peak acceleration: 981 m/s <sup>2</sup> (≒100G) Duration of pulse: 6 ms 3 times in each of 6(±X, ±Y, ±Z) axes  Three successive shock shall be applied in the perpendicular direction of each surface of the specimen.	Meet Table A after testing.
14	Vibration	5G for 20 min, for 4 hours in each of 3(X, Y, Z) axes Test from 10-2000Hz	
15	Resistance to Soldering Heat	Pre-heating : 150 to 180 deg C / 90±30sec Reflow soldering method above 220 deg C, 60±30 sec Temperature condition above 255 deg C, above 30sec Peak : above 260deg C The specimen shall be subjected to the reflow process under the above condition 3 times. Test board shall be 1.6 mm thick. Base material shall be glass epoxy resin. The specimen shall be stored at standard atmospheric conditions for 1 h in prior to the measurement.	
17	ESD	Per AEC-Q200-002 1 time in each of terminals	Meet Table A after testing. ESD level: Meet Item 3 (Rating)
18	Solderability	Per J-STD-002 Condition SMD)C Method D Electrode shall be immersed in flux at room temperature and then shall be immersed in solder bath after preheat. Soldering 245±5 deg C, 5sec	New solder shall cover 90% minimum of the surface immersed.
19	Electrical characterization	Measured: inductance	No defects
21	Board Flex	Board : 40 × 100mm Thickness 1.6mm Apply pressure gradually in the direction of the arrow at a rate of about 0.5mm/s until bent depth reaches 2mm and hold for 60 sec. <div style="text-align: center;"> </div>	Meet Table A after testing.
22	Terminal Strength	A static load using a R0.5 pressing tool shall be applied to the body of the specimen in the direction of the arrow and shall be hold for 60s. Measure after removing pressure. Pressure 18N <div style="text-align: center;"> </div>	

## 8. Specification of Packaging

### 8.1 Appearance and Dimensions of plastic tape

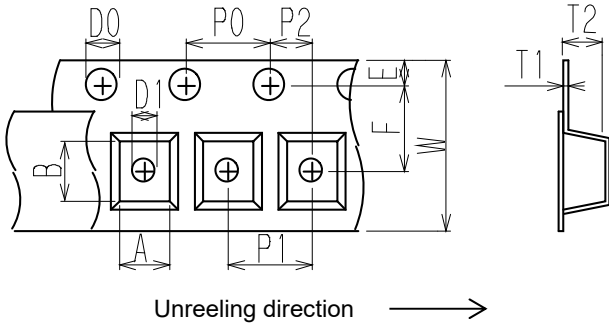

A	2.30 ±0.1	P0	4.0 ±0.1
B	2.80 ±0.1	P1	4.0 ±0.1
D0	φ 1.5 $\begin{smallmatrix} +0.1 \\ -0 \end{smallmatrix}$	P2	2.0 ±0.05
D1	φ 1.05 ±0.05	T1	0.25 ±0.05
E	1.75 ±0.1	T2	1.3 ±0.1
F	3.5 ±0.05	W	8.0 ±0.2

(in mm)

### 8.2 Specification of Taping

(1) Packing quantity (standard quantity)

3,000 pcs / reel

(2) Packing Method

Products shall be packed in the each embossed cavity of plastic tape and sealed by cover tape.

(3) Sprocket hole

The sprocket holes are to the right as the tape is pulled toward the user.

(4) Spliced point

Plastic tape and Cover tape has no spliced point.

(5) Missing components number

Missing components number within 0.1 % of the number per reel or 1 pc., whichever is greater, and are not continuous. The specified quantity per reel is kept.

### 8.3 Pull Strength

Embossed carrier tape	9.8N min.
Cover tape	10N min.

### 8.4 Peeling off force of cover tape

Speed of Peeling off	300mm/min
Peeling off force	0.1 to 0.7N (minimum value is typical)

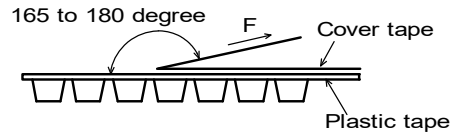

### 8.5 Dimensions of Leader-tape, Trailer and Reel

There shall be leader-tape(cover tape) and trailer-tape (empty tape) as follows.

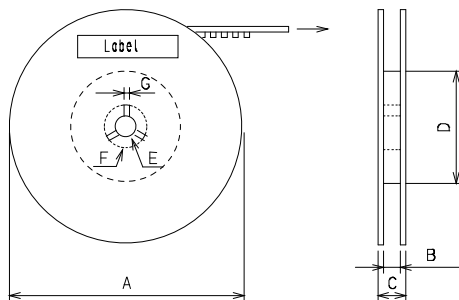
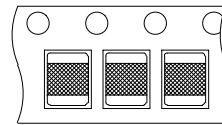
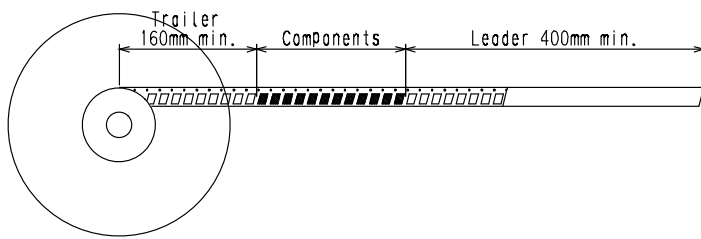

A	φ 180 $\begin{smallmatrix} +0 \\ -3 \end{smallmatrix}$
B	9 ±0.3
C	11.4 ±1
D	φ 60 ±1
E	φ 13 ±0.2
F	φ 21 ±0.8
G	2.0 ±0.5

(in mm)

### 8.6 Marking for reel

Customer part number, MURATA part number, Inspection number(\*1), RoHS marking(\*2), Quantity etc ...

\*1) <Expression of Inspection No.> LL 0000 xxx  
(1)    (2)    (3)

- (1) Factory Code
- (2) Date
  - First digit                 : Year / Last digit of year
  - Second digit                : Month / Jan. to Sep. → 1 to 9, Oct. to Dec. → O, N, D
  - Third, Fourth digit        : Day
- (3) Serial No.

\*2) « Expression of RoHS marking »        ROHS – Y (Δ)  
(1) (2)

- (1) RoHS regulation conformity
- (2) MURATA classification number

### 8.7 Marking for Outside package (corrugated paper box)

Customer name, Purchasing order number, Customer part number, MURATA part number, RoHS marking (\*2), Quantity, etc ...

### 8.8 Specification of Outer Case

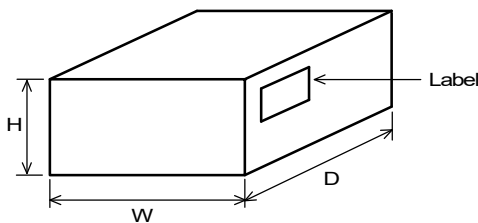

Outer Case Dimensions (mm)			Standard Reel Quantity in Outer Case (Reel)
W	D	H	
200	185	67	5

Above Outer Case size is typical. It depends on a quantity of an order.

## 9. Caution

### 9.1 Limitation of Applications

Please contact us before using our products for the applications listed below which require especially high reliability for the prevention of defects which might directly cause damage to the third party's life, body or property.

- (1) Aircraft equipment
- (6) Transportation equipment ( trains, ships, etc.)
- (2) Aerospace equipment
- (7) Traffic signal equipment
- (3) Undersea equipment
- (8) Disaster prevention / crime prevention equipment
- (4) Power plant control equipment
- (9) Data-processing equipment
- (5) Medical equipment
- (10) Applications of similar complexity and /or reliability requirements to the applications listed in the above

### 9.2 Caution(Rating)

Do not exceed maximum rated current of the product. Thermal stress may be transmitted to the product and short/open circuit of the product or falling off the product may be occurred.

### 9.3 Fail-safe

Be sure to provide an appropriate fail-safe function on your product to prevent a second damage that may be caused by the abnormal function or the failure of our product.

### 9.4 Corrosive gas

Please refrain from use since contact with environments with corrosive gases (sulfur gas [hydrogen sulfide, sulfur dioxide, etc.], chlorine, ammonia, etc.) or oils (cutting oil, silicone oil, etc.) that have come into contact with the previously stated corrosive gas environment will result in deterioration of product quality or an open from deterioration due to corrosion of product electrode, etc. We will not bear any responsibility for use under these environments.

## 10. Notice

This product is designed for solder mounting.

Please consult us in advance for applying other mounting method such as conductive adhesive.

This product employs a core with low insulation resistance, Pay strict attention when use it.

- a) Do not make any through holes and copper pattern under the coil except a copper pattern to the electrode.
- b) Design/mount any components not to contact this product.

10.1 Land pattern designing (Reflow Soldering)

Recommended land pattern for reflow soldering is as follows:

It has been designed for Electric characteristics and solderability.

Please follow the recommended patterns. Otherwise, their performance which includes electrical performance or solderability may be affected, or result to "position shift" in soldering process.

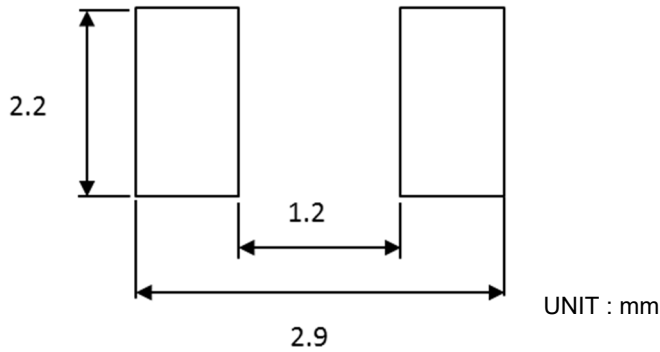

10.2 Flux, Solder

Flux	<ul style="list-style-type: none"> <li>• Use rosin-based flux.</li> <li>• Don't use highly acidic flux with halide content exceeding 0.2(wt)% (chlorine conversion value).</li> <li>• Don't use water-soluble flux.</li> </ul>
Solder	<ul style="list-style-type: none"> <li>• Use Sn-3.0Ag-0.5Cu solder</li> <li>• Standard thickness of solder paste : 100μm to 150μm</li> </ul>

Other flux (except (above) Please contact us for details, then use.

10.3 soldering conditions (Reflow)

- Pre-heating should be in such a way that the temperature difference between solder and product surface is limited to 100°C max. Cooling into solvent after soldering also should be in such a way that the temperature difference is limited to 100°C max.

Insufficient pre-heating may cause cracks on the product, resulting in the deterioration of product quality.

- Standard soldering profile profile is as follows.

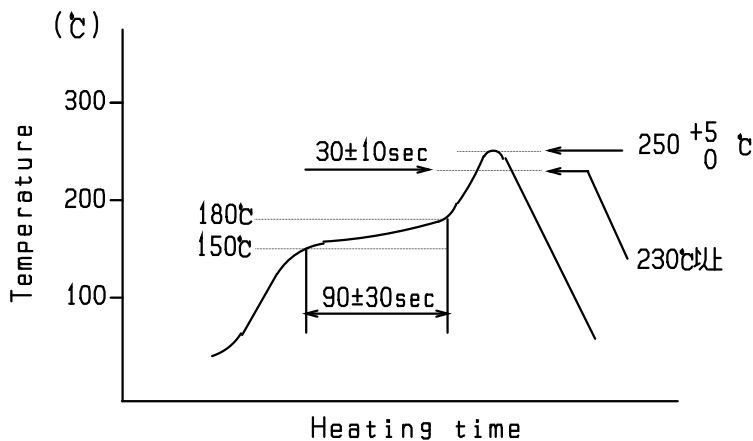

	Standard Profile
Pre-heating	150°C~180°C 、 90s±30s
Heating	above 230°C 、 20s~40s
Peak temperature	250+5/-0°C
Cycle of reflow	2 times

### 10.4 Solder Volume

- Solder shall be used not to be exceeded the upper limits as shown below.
- Accordingly increasing the solder volume, the mechanical stress to Chip is also increased. Exceeding solder volume may cause the failure of mechanical or electrical performance.

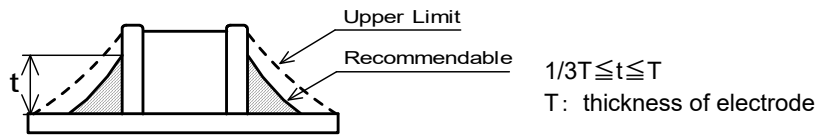

### 10.5 Product's location

The following shall be considered when designing and laying out P.C.B.'s.

- (1) P.C.B. shall be designed so that products are not subject to the mechanical stress due to warping the board.

[Products direction]

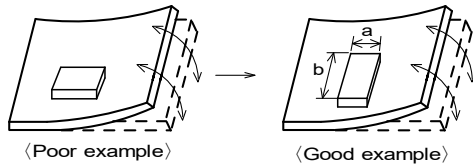

Products shall be located in the sideways direction to the mechanical stress.

- (2) Components location on P.C.B. separation.

It is effective to implement the following measures, to reduce stress in separating the board. It is best to implement all of the following three measures; however, implement as many measures as possible to reduce stress.

Contents of Measures	Stress Level
(1) Turn the mounting direction of the component parallel to the board separation surface.	A > D *1
(2) Add slits in the board separation part.	A > B
(3) Keep the mounting position of the component away from the board separation surface.	A > C

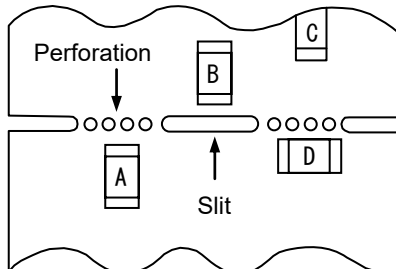

\*1 A > D is valid when stress is added vertically to the perforation as with Hand Separation. If a Cutting Disc is used, stress will be diagonal to the PCB, therefore A > D is invalid.

- (3) Mounting Components Near Screw Holes

When a component is mounted near a screw hole, it may be affected by the board deflection that occurs during the tightening of the screw. Mount the component in a position as far away from the screw holes as possible.

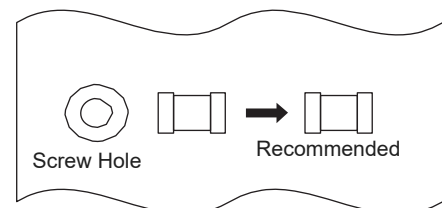

### 10.6 Resin coating

The inductance value may change and/or it may affect on the product's performance due to high cure-stress of resin to be used for coating/molding products. So please pay your careful attention when you select resin. In prior to use, please make the reliability evaluation with the product mounted in your application set.

### 10.7 Temperature rating of the circuit board and components located around

Temperature may rise up to max. 40 °C when applying the rated current to the Products. Be careful of the temperature rating of the circuit board and components located around.

### 10.8 Caution for use

There is possibility that the Impedance value change due to magnetism. Don't use a magnet or a pair of tweezers with magnetism when chip coil are handled. (The tip of the tweezers should be molded with resin or pottery.)

### 10.9 Magnetic Saturation

When the excessive current over rated current is applied, the Impedance value may change due to magnetism.

### 10.10 Handling of a substrate

After mounting products on a substrate, do not apply any stress to the product caused by bending or twisting to the substrate when cropping the substrate, inserting and removing a connector from the substrate or tightening screw to the substrate.

Excessive mechanical stress may cause cracking in the product.

**Bending**

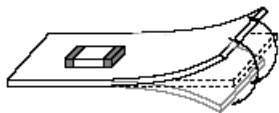

**Twisting**

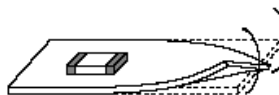

### 10.11 Storage and Handling Requirements

#### (1) Storage period

Use the products within 6 months after delivered.

Solderability should be checked if this period is exceeded.

#### (2) Storage conditions

•Products should be stored in the warehouse on the following conditions.

Temperature : -10°C to 40°C

Humidity : 15% to 85% relative humidity No rapid change on temperature and humidity

Don't keep products in corrosive gases such as sulfur, chlorine gas or acid, or it may cause oxidization of electrode, resulting in poor solderability.

•Products should be stored on the palette for the prevention of the influence from humidity, dust and so on.

•Products should be stored in the warehouse without heat shock, vibration, direct sunlight and so on.

•Avoid storing the product by itself bare (i.e.exposed directly to air).

#### (3) Handling Condition

Care should be taken when transporting or handling product to avoid excessive vibration or mechanical shock.

### 10.12 Derating

Max. current (DC, AC) as function of product temperature (derating curve)

$I_{OP}$  : Loaded Current

$I_R$  : Rated Current

Current Derating Curve

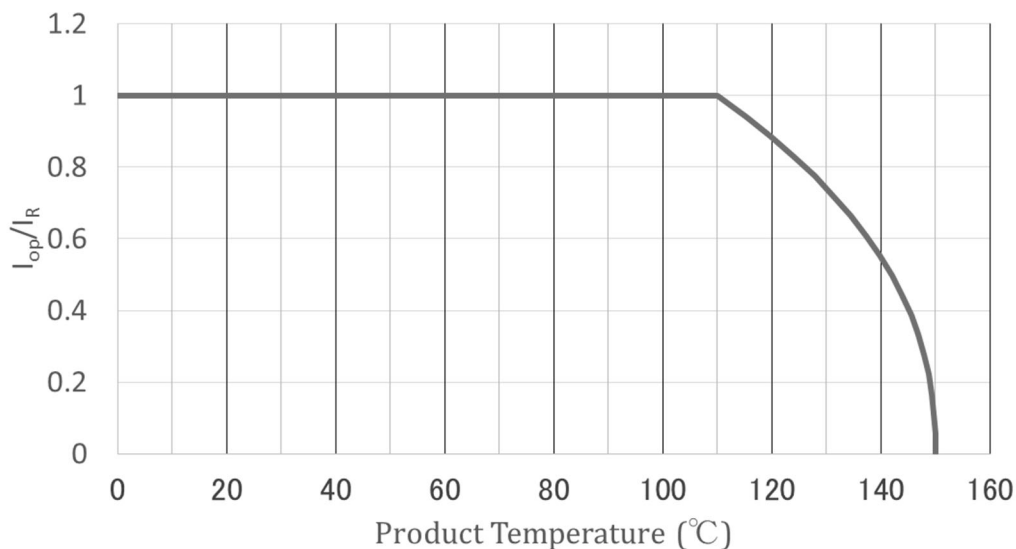



**11.  Note**

- (1) Please make sure that your product has been evaluated in view of your specifications with our product being mounted to your product.
  - (2) You are requested not to use our product deviating from the reference specifications.
  - (3) The contents of this reference specification are subject to change without advance notice.
- Please approve our product specifications or transact the approval sheet for product specifications before ordering.

# Mouser Electronics

Authorized Distributor

Click to View Pricing, Inventory, Delivery & Lifecycle Information:

[Murata:](#)

[DFE2HCAHR33MJ0L](#) [DFE2HCAHR47MJ0L](#) [DFE2HCAH1R5MJ0L](#) [DFE2HCAHR68MJ0L](#) [DFE2HCAH1R0MJ0L](#)  
[DFE2HCAH2R2MJ0L](#)