



Is Now Part of



**ON Semiconductor®**

To learn more about ON Semiconductor, please visit our website at  
[www.onsemi.com](http://www.onsemi.com)

Please note: As part of the Fairchild Semiconductor integration, some of the Fairchild orderable part numbers will need to change in order to meet ON Semiconductor's system requirements. Since the ON Semiconductor product management systems do not have the ability to manage part nomenclature that utilizes an underscore (\_), the underscore (\_) in the Fairchild part numbers will be changed to a dash (-). This document may contain device numbers with an underscore (\_). Please check the ON Semiconductor website to verify the updated device numbers. The most current and up-to-date ordering information can be found at [www.onsemi.com](http://www.onsemi.com). Please email any questions regarding the system integration to [Fairchild\\_questions@onsemi.com](mailto:Fairchild_questions@onsemi.com).

ON Semiconductor and the ON Semiconductor logo are trademarks of Semiconductor Components Industries, LLC dba ON Semiconductor or its subsidiaries in the United States and/or other countries. ON Semiconductor owns the rights to a number of patents, trademarks, copyrights, trade secrets, and other intellectual property. A listing of ON Semiconductor's product/patent coverage may be accessed at [www.onsemi.com/site/pdf/Patent-Marking.pdf](http://www.onsemi.com/site/pdf/Patent-Marking.pdf). ON Semiconductor reserves the right to make changes without further notice to any products herein. ON Semiconductor makes no warranty, representation or guarantee regarding the suitability of its products for any particular purpose, nor does ON Semiconductor assume any liability arising out of the application or use of any product or circuit, and specifically disclaims any and all liability, including without limitation special, consequential or incidental damages. Buyer is responsible for its products and applications using ON Semiconductor products, including compliance with all laws, regulations and safety requirements or standards, regardless of any support or applications information provided by ON Semiconductor. "Typical" parameters which may be provided in ON Semiconductor data sheets and/or specifications can and do vary in different applications and actual performance may vary over time. All operating parameters, including "Typicals" must be validated for each customer application by customer's technical experts. ON Semiconductor does not convey any license under its patent rights nor the rights of others. ON Semiconductor products are not designed, intended, or authorized for use as a critical component in life support systems or any FDA Class 3 medical devices or medical devices with a same or similar classification in a foreign jurisdiction or any devices intended for implantation in the human body. Should Buyer purchase or use ON Semiconductor products for any such unintended or unauthorized application, Buyer shall indemnify and hold ON Semiconductor and its officers, employees, subsidiaries, affiliates, and distributors harmless against all claims, costs, damages, and expenses, and reasonable attorney fees arising out of, directly or indirectly, any claim of personal injury or death associated with such unintended or unauthorized use, even if such claim alleges that ON Semiconductor was negligent regarding the design or manufacture of the part. ON Semiconductor is an Equal Opportunity/Affirmative Action Employer. This literature is subject to all applicable copyright laws and is not for resale in any manner.



# FPF3040 IntelliMAX™ 18 V-Rated Dual Input Single Output Power-Source-Selector Switch

## Features

- Dual-Input, Single-Output Load Switch
- Input Supply Operating Range:
  - 4~10.5 V at  $V_{IN}$
  - 4~6.5 V at  $V_{BUS}$
- Typical  $R_{ON}$ :
  - 95 m $\Omega$  at  $V_{IN}=5$  V
  - 70 m $\Omega$  at  $V_{BUS}=5$  V
- Bi-Directional Switch for  $V_{IN}$  and  $V_{BUS}$
- Slew Rate Controlled:
  - 50  $\mu$ s at  $V_{IN}$  for  $< 4.7$   $\mu$ F  $C_{OUT}$
  - 90  $\mu$ s at  $V_{BUS}$  for  $< 4.7$   $\mu$ F  $C_{OUT}$
- Maximum  $I_{SW}$ : 2 A Per Channel
- Break-Before-Make Transition
- Under-Voltage Lockout (UVLO)
- Over-Voltage Lockout (OVLO)
- Thermal Shutdown
- Logic CMOS IO Meets JESD76 Standard for GPIO Interface and Related Power Supply Requirements
- ESD Protected:
  - Human Body Model:  $>3$  kV
  - Charged Device Model:  $>1.5$  kV
  - IEC 61000-4-2 Air Discharge:  $>15$  kV
  - IEC61000-4-2 Contact Discharge:  $>8$  kV

## Description

The FPF3040 is a 18 V-rated Dual-Input Single-Output (DISO) load switch consisting of two channels of slew-rate-controlled, low-on-resistance, N-channel MOSFET switches with protection features. The slew-rate-controlled turn-on characteristic prevents inrush current and the resulting excessive voltage droop on the input power rails. The input voltage range operates from 4 V to 6.5 V at  $V_{BUS}$  and from 4 V to 10.5 V at  $V_{IN}$  to align with the needs of low-voltage portable device power rails.

$V_{IN}$  and  $V_{BUS}$  have the over-voltage protection functionality of typical 12 V and 7.5 V, respectively, to avoid unwanted damage to system.

$V_{IN}$  and  $V_{BUS}$  bi-directional switching allows reverse current from  $V_{OUT}$  to  $V_{IN}$  or  $V_{BUS}$  for On-The-Go, (OTG) Mode. The switching is controlled by logic input EN and  $V_{IN\_SEL}$  is capable of interfacing directly with low-voltage control signal General-Purpose Input / Output (GPIO).

FPF3040 is available in 1.8 mm x 2.0 mm Wafer-Level Chip-Scale Package (WLCSP), 16-bump, 0.4 mm pitch.

## Applications

- Input Power Selection Block Supporting USB and Wireless Charging
- Smartphone / Tablet PC

## Ordering Information

Part Number	Top Mark	Channel	Typical $R_{ON}$ per Channel at $5V_{IN}$	Rise Time ( $t_R$ )	Package
FPF3040UCX	QY	DISO	95 m $\Omega$ for $V_{IN}$	50 $\mu$ s for $V_{IN}$	1.8 mm x 2.0 mm Wafer-Level Chip-Scale Package (WLCSP), 16-Bump, 0.4 mm Pitch
			70 m $\Omega$ for $V_{BUS}$	90 $\mu$ s for $V_{BUS}$	

### Application Diagram

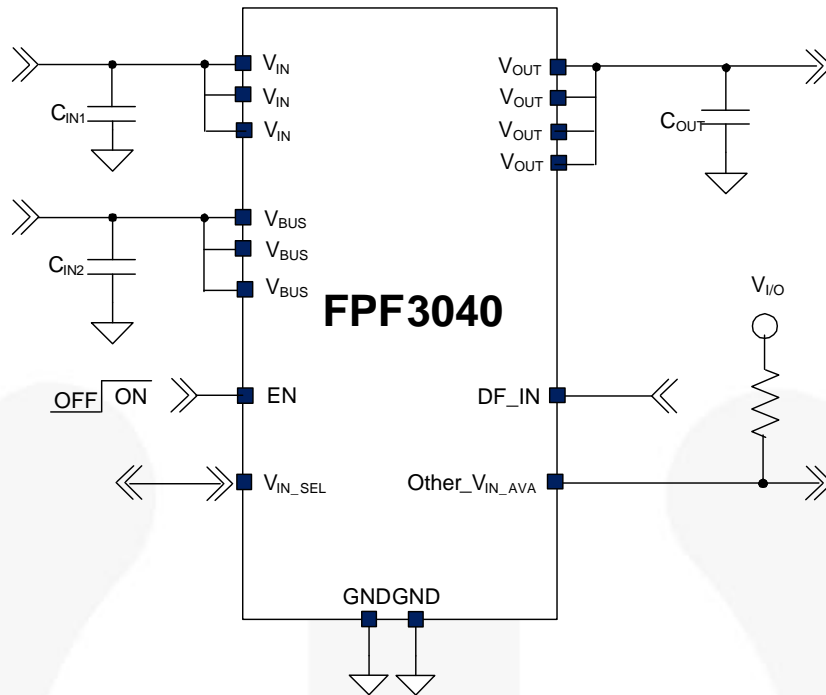

Figure 1. Typical Application

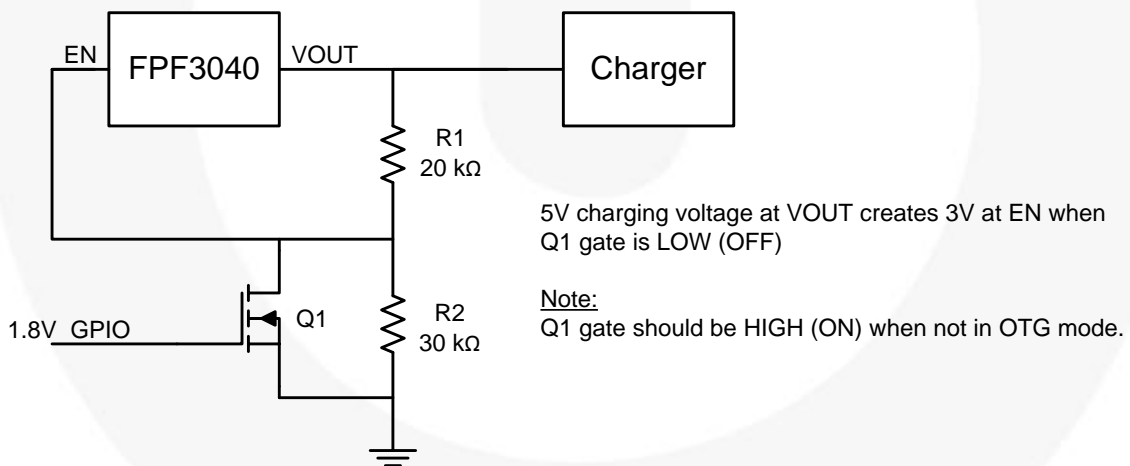

Figure 2. Example Circuit for OTG Operation with Low-Voltage GPIO

Block Diagram

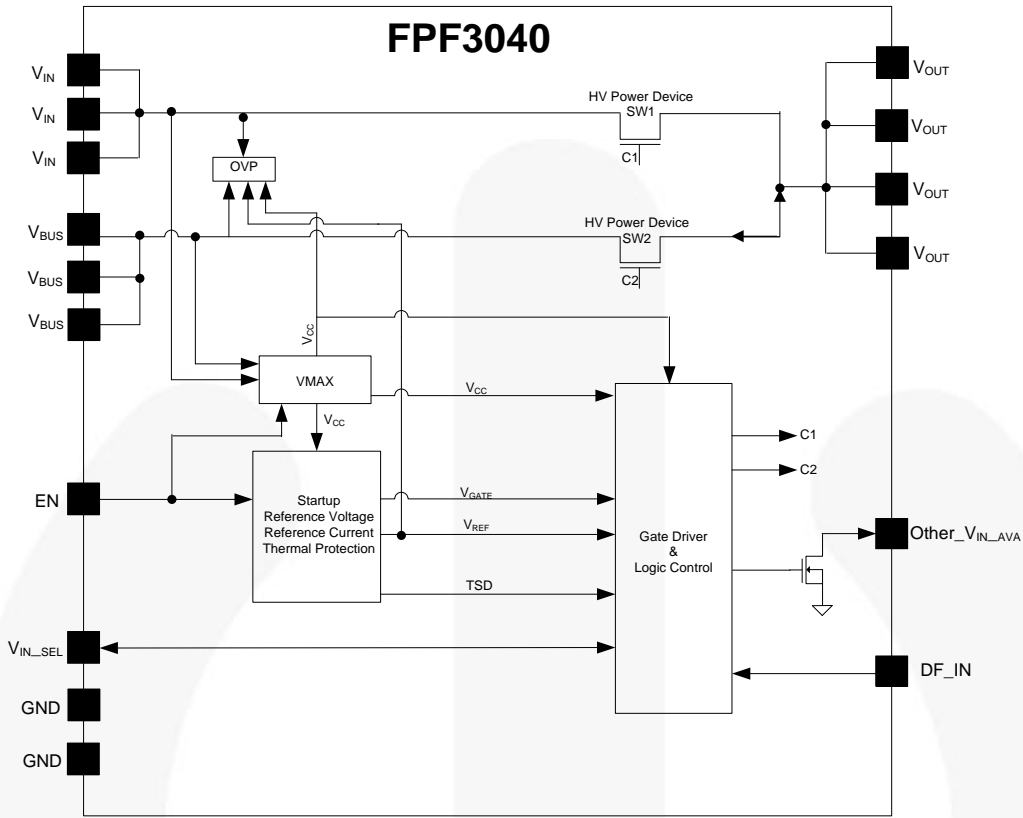

Figure 3. Functional Block Diagram



## Pin Configuration

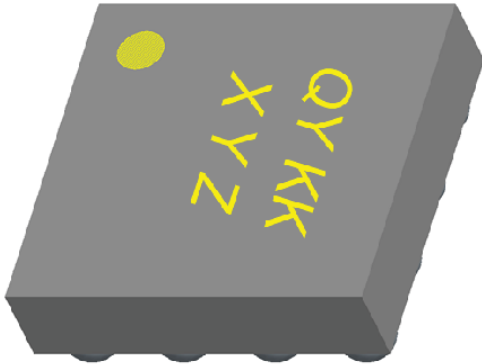

Figure 4. Pin Assignment (Top View)

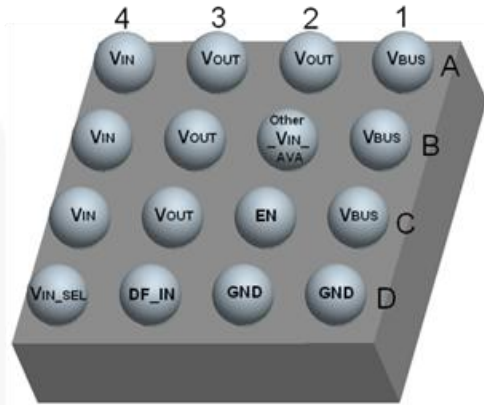

Figure 5. Pin Assignment (Bottom View)

## Pin Description

Pin #	Name	Input / Output	Description
A1, B1, C1	V <sub>BUS</sub>	Input / Output	<b>V<sub>BUS</sub> at USB:</b> Power input / output. bi-directional switch when V <sub>IN_SEL</sub> = LOW.
A4, B4, C4	V <sub>IN</sub>	Input / Output	<b>V<sub>IN</sub> Supply Input:</b> Power input / output. bi-directional switch when V <sub>IN_SEL</sub> = HIGH.
A2, A3, B3, C3	V <sub>OUT</sub>	Input / Output	<b>Switch Output:</b> Power input / output.
C2	EN	Input	<b>Enable:</b> Active HIGH. EN voltage ≥ 2.5 V can power internal circuit when V <sub>IN</sub> and V <sub>BUS</sub> are absent. 1 MΩ pull-down resistor is included.
D4	V <sub>IN_SEL</sub>	Input / Output	<b>Supply Selector &amp; Status:</b> Input power source selection input and status output. This signal is ignored during EN=LOW. Selector input during EN=HIGH: HIGH = switch V <sub>IN</sub> to V <sub>OUT</sub> / LOW = switch V <sub>BUS</sub> to V <sub>OUT</sub> . Status output during EN=LOW: HIGH = V <sub>IN</sub> is used for V <sub>OUT</sub> / LOW = V <sub>BUS</sub> is used for V <sub>OUT</sub> .
D3	DF_IN	Input	<b>Default Supply Selector during EN=LOW:</b> Input. Floating = V <sub>BUS</sub> connects to V <sub>OUT</sub> . LOW means V <sub>IN</sub> connects to V <sub>OUT</sub> . This signal is ignored during EN=HIGH. 1 μA pull-up current source is included.
B2	Other_V <sub>IN_AVA</sub>	Output	<b>Other Supply Input Status:</b> Open-drain output. HI-Z = both V <sub>IN</sub> and V <sub>BUS</sub> are valid. LOW = the other power source is not valid.
D1, D2	GND		<b>Ground</b>

**Table 1. Truth Table**

EN	V <sub>IN</sub> >UVLO	V <sub>BUS</sub> >UVLO	V <sub>IN_SEL</sub>	DF_IN	Other_V <sub>IN_AVA</sub>	V <sub>OUT</sub>	Comment
HIGH	X	X	LOW	X	HI-Z if V <sub>IN</sub> & V <sub>BUS</sub> >UVLO LOW if V <sub>IN</sub> or V <sub>BUS</sub> <UVLO	V <sub>BUS</sub>	V <sub>OUT</sub> is selected by V <sub>IN_SEL</sub> Bi-directional channel
HIGH	X	X	HIGH	X	HI-Z if V <sub>IN</sub> & V <sub>BUS</sub> >UVLO LOW if V <sub>IN</sub> or V <sub>BUS</sub> <UVLO	V <sub>IN</sub>	
LOW	YES	NO	HIGH	X	LOW	V <sub>IN</sub>	Automatic selection to valid input V <sub>IN_SEL</sub> is output.
LOW	NO	YES	LOW	X	LOW	V <sub>BUS</sub>	
LOW	YES	YES	LOW	Floating	HIGH	V <sub>BUS</sub>	V <sub>OUT</sub> is selected by DF_IN V <sub>IN_SEL</sub> is output.
LOW	YES	YES	HIGH	LOW	HIGH	V <sub>IN</sub>	
LOW	NO	NO	X	X	LOW	Floating	OFF

**Notes:**

- Internal pull-down at EN.
- 1  $\mu$ A pull-up current source at DF\_IN.

**Absolute Maximum Ratings**

Stresses exceeding the Absolute Maximum Ratings may damage the device. The device may not function or be operable above the recommended operating conditions and stressing the parts to these levels is not recommended. In addition, extended exposure to stresses above the recommended operating conditions may affect device reliability. The absolute maximum ratings are stress ratings only.

Symbol	Parameters		Min.	Max.	Unit
V <sub>PIN</sub>	V <sub>IN</sub> , V <sub>BUS</sub> to GND	Continuous	-1.4	18	V
		Pulsed, 100 ms Maximum Non-Repetitive	-2.0		
	V <sub>OUT</sub> to GND <sup>(3)</sup>		-0.3	16.0	
	EN, DF_IN, V <sub>IN_SEL</sub> , Other_V <sub>IN_AVA</sub> to GND		-0.3	6.0	
I <sub>SW</sub>	Maximum Continuous Switch Current per Channel			2	A
t <sub>PD</sub>	Total Power Dissipation at T <sub>A</sub> =25°C			2.25	W
T <sub>J</sub>	Operating Junction Temperature		-40	+150	°C
T <sub>STG</sub>	Storage Junction Temperature		-65	+150	°C
θ <sub>JA</sub>	Thermal Resistance, Junction-to-Ambient (1in. Square Pad of 2 oz. Copper)			55 <sup>(4)</sup>	°C/W
ESD	Electrostatic Discharge Capability	Human Body Model, JESD22-A114	3		kV
		Charged Device Model, JESD22-C101	1.5		
		IEC61000-4-2 System Level <sup>(5)</sup>	15		
		Contact Discharge (V <sub>IN</sub> , V <sub>BUS</sub> to GND)	8		

**Notes:**

- If external voltage of more than 10.5 V is applied to V<sub>OUT</sub>, the slew rate should be less than 1 V/ms from 10.5 V.
- Measured using 2S2P JEDEC standard PCB.
- System level ESD can be guaranteed by design.

**Recommended Operating Conditions**

The Recommended Operating Conditions table defines the conditions for actual device operation. Recommended operating conditions are specified to ensure optimal performance to the datasheet specifications. Fairchild does not recommend exceeding them or designing to Absolute Maximum Ratings.

Symbol	Parameters	Min.	Max.	Unit
V <sub>PIN</sub>	V <sub>IN</sub>	4.0	10.5	V
	V <sub>BUS</sub>	4.0	6.5	
T <sub>A</sub>	Ambient Operating Temperature	-40	+85	°C

## Electrical Characteristics

$V_{IN}$ =4 to 10.5 V,  $V_{BUS}$ =4 to 6.5 V,  $T_A$ =-40 to 85°C unless otherwise noted. Typical values are at  $V_{IN}=V_{BUS}=5$  V, EN=HIGH and  $T_A=25^\circ\text{C}$  unless otherwise noted.

Symbol	Parameters	Condition	Min.	Typ.	Max.	Unit
<b>Basic Operation</b>						
$V_{IN}$	Input Voltage		4.0		10.5	V
$V_{BUS}$			4.0		6.5	V
$I_Q$	Quiescent Current	$I_{OUT}=0$ mA, EN=HIGH, $V_{IN}$ or $V_{BUS}=5$ V		55	120	$\mu\text{A}$
		$I_{OUT}=0$ mA, EN=5 V, $V_{IN}$ and $V_{BUS}=\text{GND}$		33	70	$\mu\text{A}$
$R_{ON}$	On Resistance for $V_{IN}$	$V_{IN}=8$ V, $I_{OUT}=200$ mA, $T_A=25^\circ\text{C}$		95		m $\Omega$
		$V_{IN}=5$ V, $I_{OUT}=200$ mA, $T_A=25^\circ\text{C}$		95	150	
		$V_{IN}=5$ V, $I_{OUT}=200$ mA, $T_A=25^\circ\text{C}$ to $85^\circ\text{C}^{(6)}$			200	
	On Resistance for $V_{BUS}$	$V_{BUS}=6$ V, $I_{OUT}=200$ mA, $T_A=25^\circ\text{C}$		70		m $\Omega$
		$V_{BUS}=5$ V, $I_{OUT}=200$ mA, $T_A=25^\circ\text{C}$		70	100	
		$V_{BUS}=5$ V, $I_{OUT}=200$ mA, $T_A=25^\circ\text{C}$ to $85^\circ\text{C}^{(6)}$			140	
$V_{IH}$	Input Logic High Voltage	$V_{IN}=4$ V~10.5 V, $V_{BUS}=4$ V ~ 6.5 V	1.15			V
$V_{IL}$	Input Logic Low Voltage	$V_{IN}=4$ V~10.5 V, $V_{BUS}=4$ V ~ 6.5 V			0.52	V
$V_{EN(OTG)}$	EN Voltage in OTG Mode <sup>(6)</sup>	$V_{IN}$ & $V_{BUS}=\text{Float}$ or $V_{IN}$ & $V_{BUS} < V_{UVLO}$	2.5			V
$R_{EN\_PD}$	Pull-Down Resistance at EN		707	1000	1360	k $\Omega$
<b>Protection</b>						
$V_{UVLO}$	Under-Voltage Lockout Threshold	$V_{IN}$ or $V_{BUS}$ Rising	3.05	3.50	4.00	V
		$V_{IN}$ or $V_{BUS}$ Falling	2.55	3.00	3.55	V
$V_{UVHYS}$	Under-Voltage Lockout Hysteresis			0.5		V
$V_{OVLO}$	Over-Voltage Lockout Threshold	$V_{IN}$ Rising Threshold	10.85	12.00	13.45	V
		$V_{IN}$ Falling Threshold		11.5		V
		$V_{BUS}$ Rising Threshold	6.52	7.50	8.32	V
		$V_{BUS}$ Falling Threshold		7		V
$V_{OVHYS}$	Over-Voltage Lockout Hysteresis	$V_{IN}$		0.5		V
		$V_{BUS}$		0.5		V
$T_{SDN}$	Thermal Shutdown Threshold			150		$^\circ\text{C}$
$T_{SDNHYS}$	Thermal Shutdown Hysteresis			20		$^\circ\text{C}$
<b>Reverse Current Blocking</b>						
$I_{RCB}$	$V_{IN}$ or $V_{BUS}$ Current During RCB	$V_{OUT}=8$ V, $V_{IN}$ or $V_{BUS}=\text{GND}$			30	$\mu\text{A}$
<b>Dynamic Characteristics</b>						
$t_R$	$V_{OUT}$ Rise Time, $V_{BUS}^{(6,7)}$	$V_{IN}=V_{BUS}=5$ V, $R_L=150$ $\Omega$ , $C_L=4.7$ $\mu\text{F}$ , $T_A=25^\circ\text{C}$		90		$\mu\text{s}$
	$V_{OUT}$ Rise Time, $V_{IN}^{(6,7)}$			50		
$t_F$	$V_{OUT}$ Fall Time <sup>(6,7)</sup>			1.4		ms
$t_{TRAN}$	Transition Delay <sup>(6,7)</sup>			50	100	ms
$t_{SD}$	Selection Delay <sup>(6,7)</sup>				50	$\mu\text{s}$

### Notes:

- This parameter is guaranteed by characterization and/or design; not production tested.
- $t_{SD}/t_{TRAN}/t_R/t_F$  are defined in Figure 6.

Timing Diagram

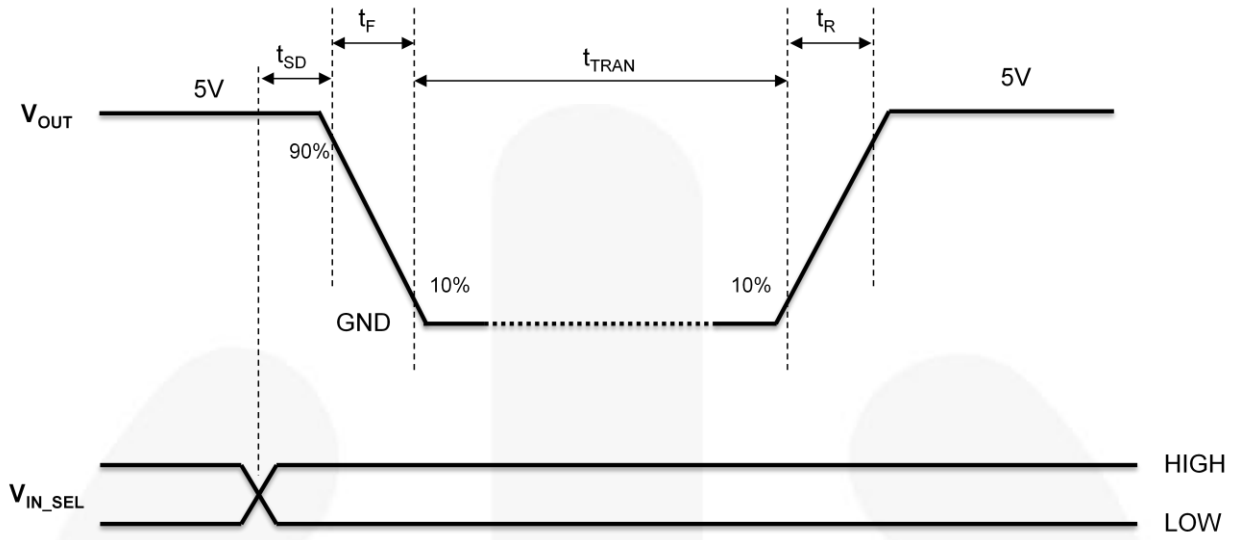

Figure 6. Transition Delay ( $V_{IN}=V_{BUS}=5\text{ V}$ )





## Typical Characteristics

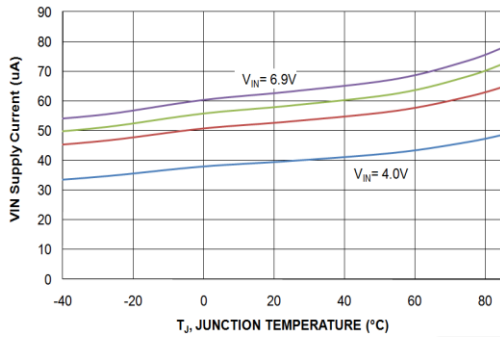

Figure 7.  $V_{IN}$  Quiescent Current ( $I_q$ ) vs. Temperature

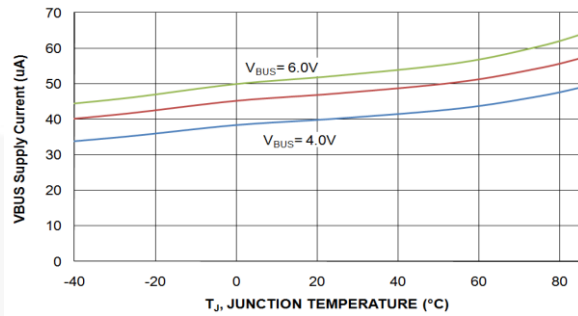

Figure 8.  $V_{BUS}$  Quiescent Current ( $I_q$ ) vs. Temperature

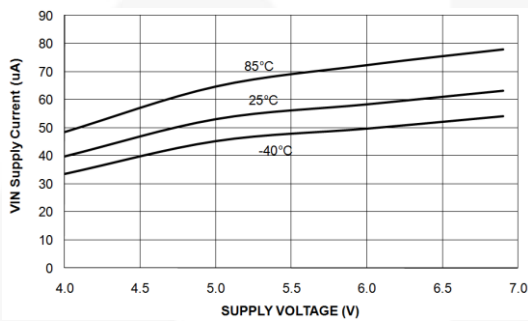

Figure 9.  $V_{IN}$  Quiescent Current vs. Supply Voltage

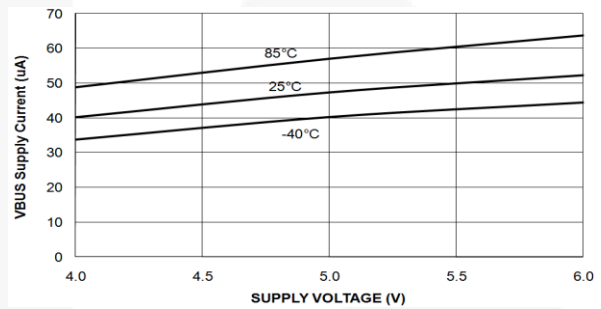

Figure 10.  $V_{BUS}$  Quiescent Current vs. Supply Voltage

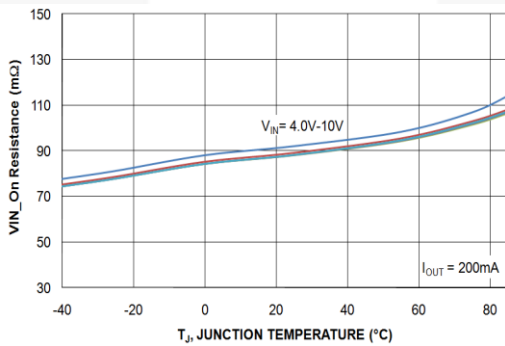

Figure 11.  $V_{IN}$  On Resistance ( $m\Omega$ ) vs. Temperature

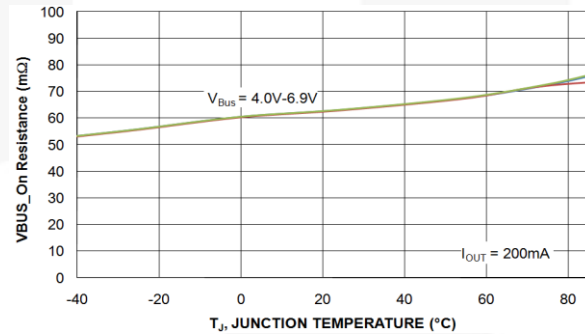

Figure 12.  $V_{BUS}$  On Resistance ( $m\Omega$ ) vs. Temperature

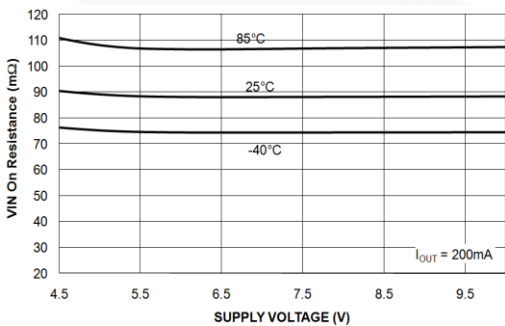

Figure 13.  $V_{IN}$  On Resistance ( $m\Omega$ ) vs. Supply Voltage

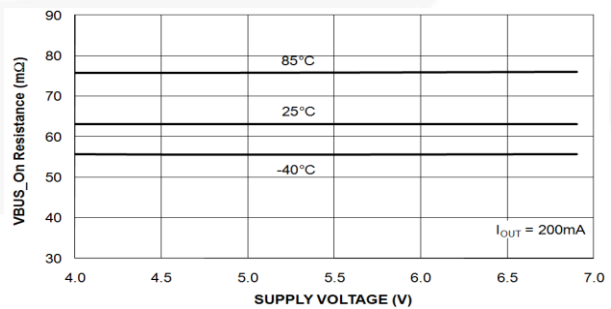

Figure 14.  $V_{BUS}$  On Resistance ( $m\Omega$ ) vs. Supply Voltage

Typical Characteristics (Continued)

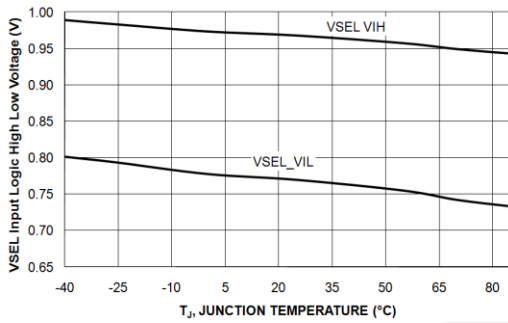

Figure 15.  $V_{IN\_SEL}$  Input Logic High & Low Voltage vs. Temperature

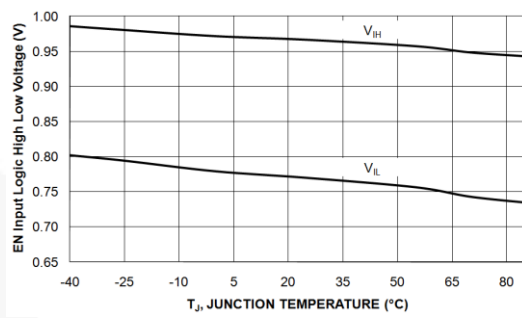

Figure 16. EN Input Logic High & Low Voltage vs. Temperature

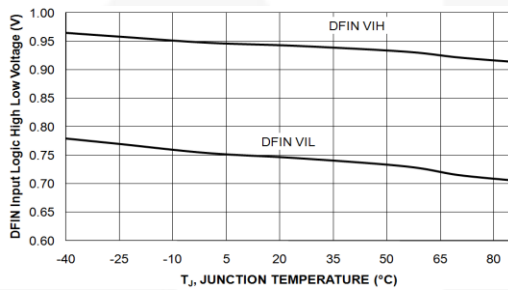

Figure 17.  $DF\_IN$  Logic High & Low Voltage vs. Temperature

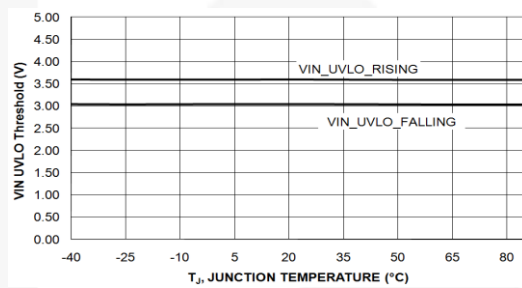

Figure 18.  $V_{IN\_VULVO}$  vs. Temperature

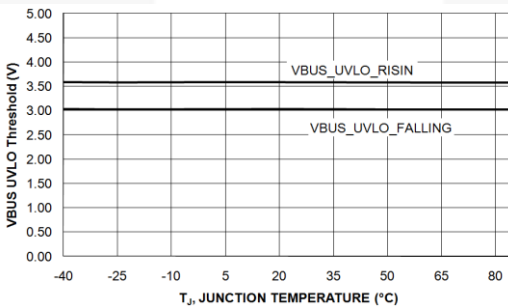

Figure 19.  $V_{BUS\_VULVO}$  vs. Temperature

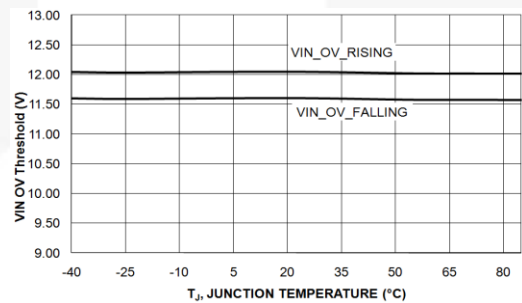

Figure 20.  $V_{IN\_VOVLO}$  vs. Temperature

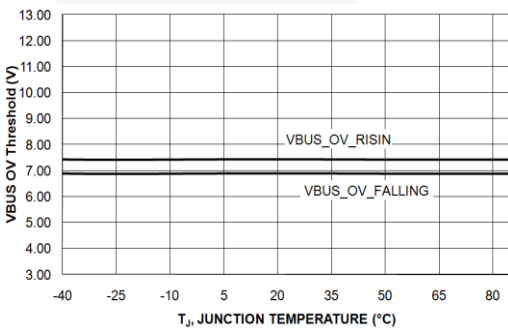

Figure 21.  $V_{BUS\_VOVLO}$  vs. Temperature

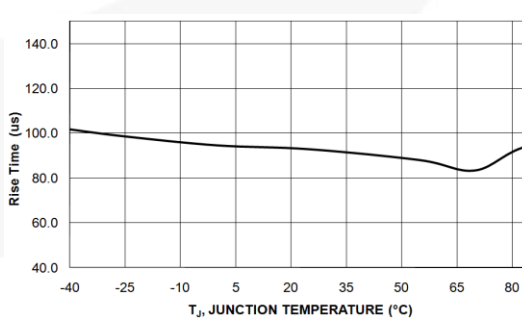

Figure 22.  $V_{OUT}$   $t_R$  vs. Temperature

Typical Characteristics (Continued)

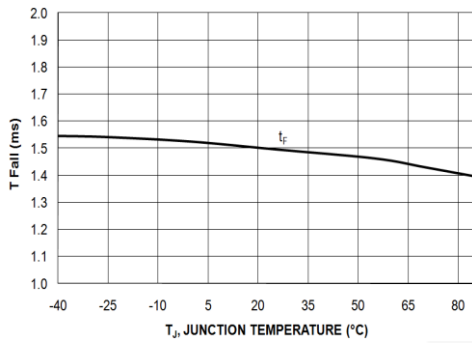

Figure 23.  $V_{OUT}$   $t_F$  vs. Temperature

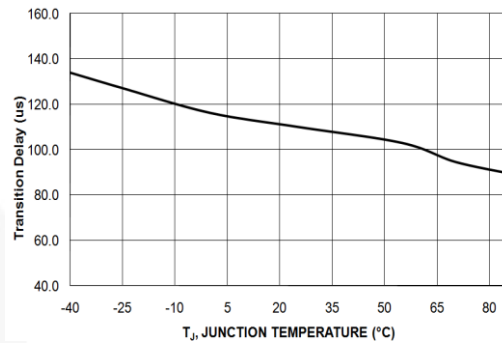

Figure 24.  $t_{TRAN}$  vs. Temperature

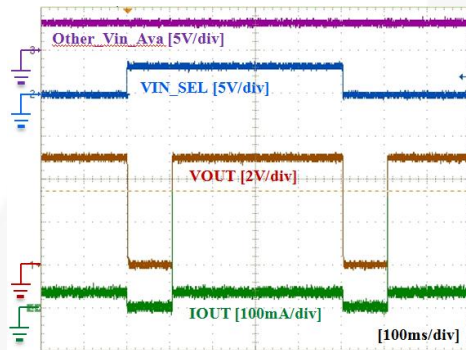

Figure 25. Power Source Transition ( $V_{IN}=V_{BUS}=5$  V,  $EN=HIGH$ ,  $V_{IN\_SEL}=LOW \rightarrow HIGH \rightarrow LOW$ ,  $C_{OUT}=4.7$   $\mu F$ ,  $R_L=150$   $\Omega$ )

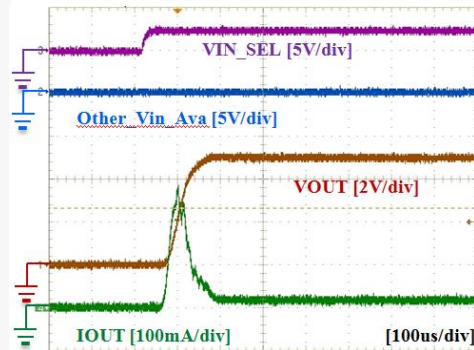

Figure 26.  $V_{IN}$  On Response ( $V_{IN}=GND \rightarrow 5$  V,  $V_{BUS}=EN=GND$ ,  $C_{OUT}=4.7$   $\mu F$ ,  $R_L=150$   $\Omega$ )

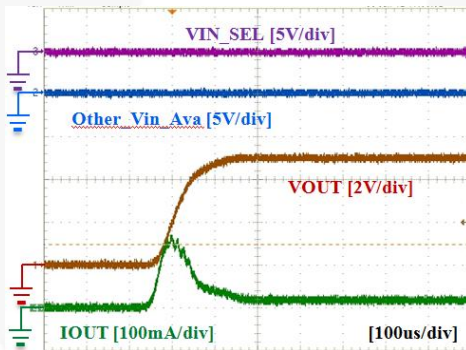

Figure 27.  $V_{BUS}$  On Response ( $V_{BUS}=GND \rightarrow 5$  V,  $V_{IN}=EN=GND$ ,  $C_{OUT}=4.7$   $\mu F$ ,  $R_L=150$   $\Omega$ )

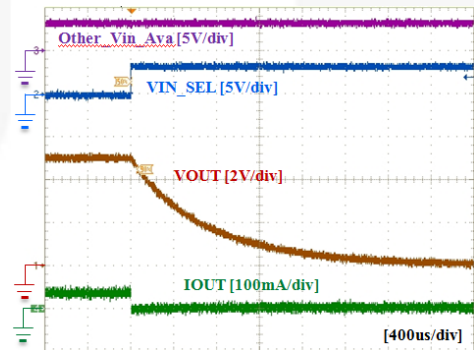

Figure 28. Off Response ( $V_{IN}=V_{BUS}=5$  V,  $EN=HIGH$ ,  $V_{IN\_SEL}=LO \rightarrow HIGH$  or  $HIGH \rightarrow LOW$ ,  $C_{OUT}=4.7$   $\mu F$ ,  $R_L=150$   $\Omega$ )

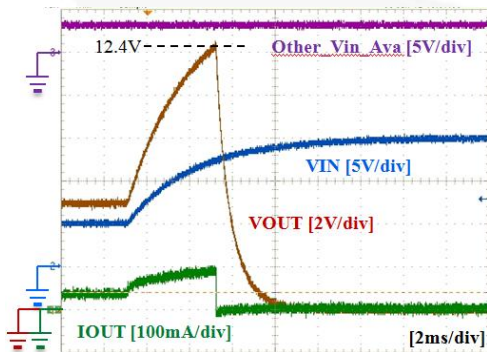

Figure 29.  $V_{IN}$  Over-Voltage Protection Response ( $V_{IN}=5$  V  $\rightarrow 15$  V,  $V_{BUS}=5$  V,  $EN=V_{IN\_SEL}=HIGH$ ,  $C_{OUT}=4.7$   $\mu F$ ,  $R_L=150$   $\Omega$ )

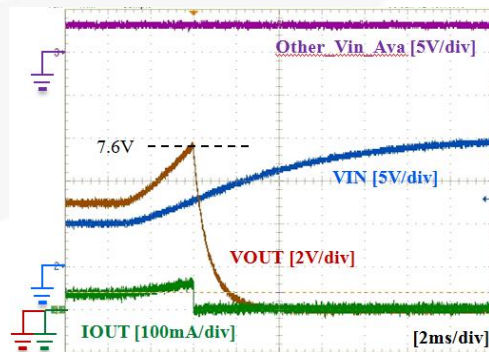

Figure 30.  $V_{BUS}$  Over-Voltage Protection Response ( $V_{BUS}=5$  V  $\rightarrow 15$  V,  $V_{IN}=5$  V,  $EN=HIGH$ ,  $V_{IN\_SEL}=LOW$ ,  $C_{OUT}=4.7$   $\mu F$ ,  $R_L=150$   $\Omega$ )

## Operation and Application Information

The FPF3040 is a 18 V, 2 A-rated, Dual-Input Single-Output (DISO) load switch with slew-rate-controlled, low-on-resistance, based-on-N-channel MOSFET. The input operating range is from 4 V to 6.5 V at  $V_{BUS}$  and from 4 V to 10.5 V at  $V_{IN}$ . The internal circuitry is powered from the highest voltage source among  $V_{IN}$ ,  $V_{BUS}$ , and  $V_{EN}$ .

### Input Power Source Selection

Input power source can be selected by  $V_{IN\_SEL}$  and  $DF\_IN$ , respectively, depending on EN state. When EN is HIGH, the input source is selected by  $V_{IN\_SEL}$  regardless of  $DF\_IN$ . If  $V_{IN\_SEL}$  is LOW,  $V_{BUS}$  is selected. If  $V_{IN\_SEL}$  is HIGH,  $V_{IN}$  is selected.

**Table 2. Input Power Selection by  $V_{IN\_SEL}$**

EN	$V_{IN}>UVLO$	$V_{BUS}>UVLO$	$V_{IN\_SEL}$	$DF\_IN$	$V_{OUT}$
HIGH	X	X	LOW	X	$V_{BUS}$
HIGH	X	X	HIGH	X	$V_{IN}$

When EN is LOW, the input source is selected by  $DF\_IN$  and the number of valid input sources. If only one input source is valid, or more than UVLO, the source is selected automatically, regardless of  $DF\_IN$ , to make a charging path in case the battery is depleted. If both  $V_{BUS}$  and  $V_{IN}$  have valid input sources, the input source is selected by  $DF\_IN$ . If  $DF\_IN$  is LOW,  $V_{IN}$  is selected. If  $DF\_IN$  is HIGH or floating,  $V_{BUS}$  is selected.  $DF\_IN$  is biased HIGH with an internal 1  $\mu$ A pull-up current source.

**Table 3. Input Power Selection by  $DF\_IN$**

EN	$V_{IN}>UVLO$	$V_{BUS}>UVLO$	$V_{IN\_SEL}$	$DF\_IN$	$V_{OUT}$
LOW	YES	NO	HIGH	X	$V_{IN}$
LOW	NO	YES	LOW	X	$V_{BUS}$
LOW	YES	YES	LOW	Floating	$V_{BUS}$
LOW	YES	YES	HIGH	LOW	$V_{IN}$
LOW	NO	NO	X	X	Floating

$V_{IN\_SEL}$  can be the status output to indicate which input power source is used during EN is LOW. If  $V_{IN}$  is used,  $V_{IN\_SEL}$  shows high. If  $V_{BUS}$  is used,  $V_{IN\_SEL}$  shows LOW. The voltage level of HIGH signal is 5.3 V if any one of

$V_{IN}$ ,  $V_{BUS}$  or EN is higher than 5.3 V. The signal is highest voltage among  $V_{IN}$ ,  $V_{BUS}$ , and  $V_{EN}$  if none of them is higher than 5.3 V.

### EN Voltage for Control Logic Power Supply

Internal control logic is powered from the highest voltage among  $V_{IN}$ ,  $V_{BUS}$ , and  $V_{EN}$ . If valid  $V_{IN}$  or  $V_{BUS}$  higher than UVLO is applied, ON/OFF control by EN should be accomplished with  $V_{IH}/V_{IL}$ . If EN powers the internal control block without valid  $V_{IN}$  and  $V_{BUS}$ , more than 2.5 V is required on the EN pin to operate properly.

### Over-Voltage Protection (OVP)

FPF3040 has over-voltage protection at both  $V_{IN}$  and  $V_{BUS}$ . If  $V_{IN}$  or  $V_{BUS}$  is higher than 12 V or 7.5 V, respectively, the power switch is off until input voltage is lower than the over-voltage trip level by hysteresis voltage of 0.5 V.

### Reverse Power Supply for OTG

FPF3040 has a bi-directional switch so reverse power is allowed for On-The-Go (OTG) operation. Even if both  $V_{IN}$  and  $V_{BUS}$  are not available, reverse power can be also supported if internal control circuitry is powered by EN.

### Reverse-Current Blocking

FPF3040 supports reverse-current blocking during EN LOW and an unselected channel.

### Thermal Shutdown

During FPF3040 thermal shutdown, the power switch is turned off if junction temperature reaches over 150°C to avoid damage.

### Wireless Charging System

FPF3040 can be used for an input power selector supporting Travel Adaptor (TA) and Wireless Charging (WC) with a single-input-based battery charger or Power Management IC (PMIC), including a charging block as shown in Figure 31. The system can recognize an input power source change between 5 V TA and 5 V WC without detection circuitry because FPF3040 has a 100 ms transition delay. OTG Mode can be supported without an additional power path, such as a MOSFET.

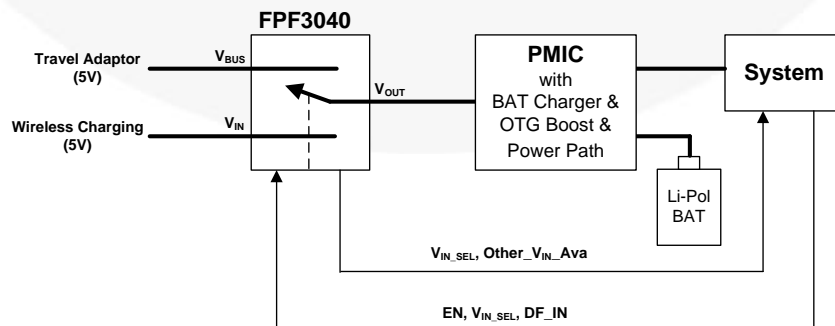

**Figure 31. Block Diagram of Input Power Selector for Wireless Charging System**

**Product Specific Package Information**

D	E	X	Y
1.96 mm ±0.03 mm	1.76 mm ±0.03 mm	0.28 mm	0.38 mm



REVISIONS			
REV	DESCRIPTION	DATE	APP'D / SITE
1	Initial drawing release.	3-31-08	L. England
2	Changed land pad solder mask to individual pad openings. Other general updates for drawing consistency.	3-31-08	L. England / FSME

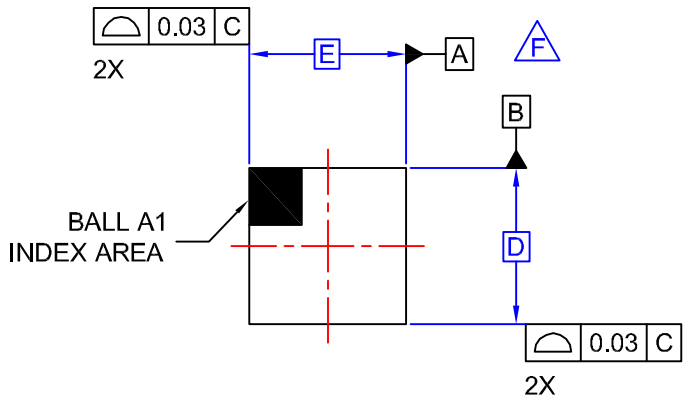

TOP VIEW

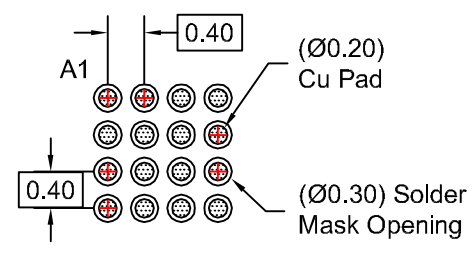

RECOMMENDED LAND PATTERN (NSMD PAD TYPE)

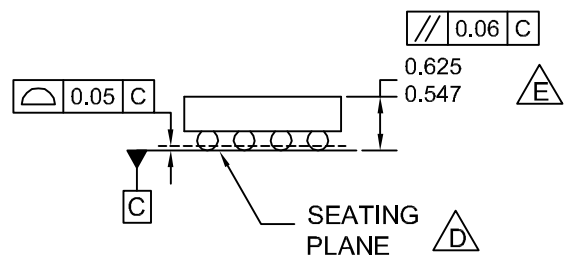

SIDE VIEWS

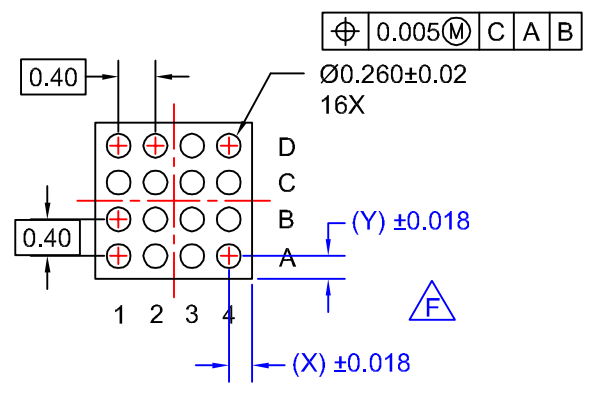
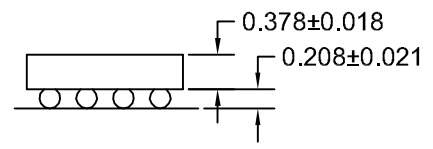

BOTTOM VIEW

NOTES:

- A. NO JEDEC REGISTRATION APPLIES.
- B. DIMENSIONS ARE IN MILLIMETERS.
- C. DIMENSIONS AND TOLERANCE PER ASME Y14.5M, 1994.
- D. DATUM C IS DEFINED BY THE SPHERICAL CROWNS OF THE BALLS.
- E. PACKAGE NOMINAL HEIGHT IS 586 MICRONS ±39 MICRONS (547-625 MICRONS).
- F. FOR DIMENSIONS D, E, X, AND Y SEE PRODUCT DATASHEET.
- G. DRAWING FILNAME: MKT-UC016Arev2.

<b>APPROVALS</b>		<b>DATE</b>			
DRAWN	L. England	10-26-09			
DFTG. CHK.	E. Shacham	10-26-09			
ENGR. CHK.					
			<b>16BALL WLCSP, 4X4 ARRAY</b> <b>0.4MM PITCH, 250UM BALL</b>		
		SCALE	SIZE	DRAWING NUMBER	REV
		N/A	N/A	MKT-UC016AA	2
			DO NOT SCALE DRAWING	SHEET 1 of 1	

ON Semiconductor and  are trademarks of Semiconductor Components Industries, LLC dba ON Semiconductor or its subsidiaries in the United States and/or other countries. ON Semiconductor owns the rights to a number of patents, trademarks, copyrights, trade secrets, and other intellectual property. A listing of ON Semiconductor's product/patent coverage may be accessed at [www.onsemi.com/site/pdf/Patent-Marking.pdf](http://www.onsemi.com/site/pdf/Patent-Marking.pdf). ON Semiconductor reserves the right to make changes without further notice to any products herein. ON Semiconductor makes no warranty, representation or guarantee regarding the suitability of its products for any particular purpose, nor does ON Semiconductor assume any liability arising out of the application or use of any product or circuit, and specifically disclaims any and all liability, including without limitation special, consequential or incidental damages. Buyer is responsible for its products and applications using ON Semiconductor products, including compliance with all laws, regulations and safety requirements or standards, regardless of any support or applications information provided by ON Semiconductor. "Typical" parameters which may be provided in ON Semiconductor data sheets and/or specifications can and do vary in different applications and actual performance may vary over time. All operating parameters, including "Typicals" must be validated for each customer application by customer's technical experts. ON Semiconductor does not convey any license under its patent rights nor the rights of others. ON Semiconductor products are not designed, intended, or authorized for use as a critical component in life support systems or any FDA Class 3 medical devices or medical devices with a same or similar classification in a foreign jurisdiction or any devices intended for implantation in the human body. Should Buyer purchase or use ON Semiconductor products for any such unintended or unauthorized application, Buyer shall indemnify and hold ON Semiconductor and its officers, employees, subsidiaries, affiliates, and distributors harmless against all claims, costs, damages, and expenses, and reasonable attorney fees arising out of, directly or indirectly, any claim of personal injury or death associated with such unintended or unauthorized use, even if such claim alleges that ON Semiconductor was negligent regarding the design or manufacture of the part. ON Semiconductor is an Equal Opportunity/Affirmative Action Employer. This literature is subject to all applicable copyright laws and is not for resale in any manner.

## PUBLICATION ORDERING INFORMATION

### LITERATURE FULFILLMENT:

Literature Distribution Center for ON Semiconductor  
19521 E. 32nd Pkwy, Aurora, Colorado 80011 USA  
**Phone:** 303-675-2175 or 800-344-3860 Toll Free USA/Canada  
**Fax:** 303-675-2176 or 800-344-3867 Toll Free USA/Canada  
**Email:** [orderlit@onsemi.com](mailto:orderlit@onsemi.com)

**N. American Technical Support:** 800-282-9855 Toll Free  
USA/Canada  
**Europe, Middle East and Africa Technical Support:**  
Phone: 421 33 790 2910  
**Japan Customer Focus Center**  
Phone: 81-3-5817-1050

**ON Semiconductor Website:** [www.onsemi.com](http://www.onsemi.com)  
**Order Literature:** <http://www.onsemi.com/orderlit>  
For additional information, please contact your local  
Sales Representative