

# Programmable Shunt Regulator

## KA431S, KA431SA, KA431SL

### Description

The KA431S / KA431SA / KA431SL are three-terminal adjustable regulator series with a guaranteed thermal stability over the operating temperature range. The output voltage can be set to any value between  $V_{REF}$  (approximately 2.5 V) and 36 V with two external resistors. These devices have a typical dynamic output impedance of 0.2  $\Omega$ . Active output circuitry provides a sharp turn-on characteristic, making these devices excellent replacement for zener diodes in many applications.

### Features

- Programmable Output Voltage to 36 V
- Low Dynamic Output Impedance 0.2  $\Omega$  (Typical)
- Sink Current Capability: 1.0 to 100 mA
- Equivalent Full-Range Temperature Coefficient of 50 ppm/ $^{\circ}C$  (Typical)
- Temperature Compensated for Operation Over Full Rated Operating Temperature Range
- Low Output Noise Voltage
- Fast Turn-on Response
- These Devices are Pb-Free and Halogen Free

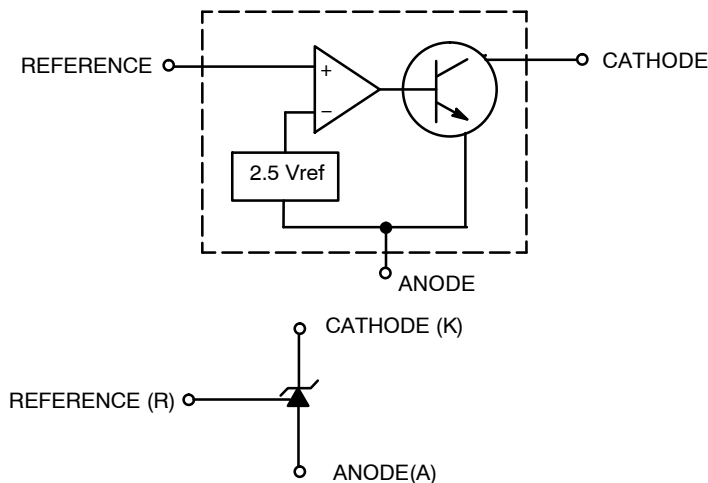
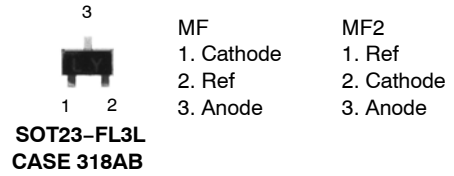

Figure 1. Block Diagram



### DEVICE MARKING INFORMATION

See general marking information in the device marking section on page 2 of this data sheet.

### ORDERING INFORMATION

See detailed ordering and shipping information on page 6 of this data sheet.

# KA431S, KA431SA, KA431SL

## MARKING INFORMATION



Figure 2. Top Mark (per package)

### ABSOLUTE MAXIMUM RATINGS

$T_A = 25^\circ\text{C}$  unless otherwise noted

| Symbol          | Parameter  | Value       | Unit                      |
|-----------------|--|-------------|---------------------------|
| $V_{KA}$        | Cathode Voltage  | 37          | V                         |
| $I_{KA}$        | Cathode Current Range (Continuous)                                     | -100 ~ +150 | mA                        |
| $I_{REF}$       | Reference Input Current Range  | -0.05 ~ +10 | mA                        |
| $R_{\theta JA}$ | Thermal Resistance Junction-Air (Note 1) (Note 2)<br>MF Suffix Package | 350         | $^\circ\text{C}/\text{W}$ |
| $I_{REF}$       | Power Dissipation (Note 3) (Note 4)<br>MF Suffix Package               | 350         | mW                        |
| $T_J$           | Junction Temperature   | 150         | $^\circ\text{C}$          |
| $T_{OPR}$       | Operating Temperature Range  | -25 ~ +85   | $^\circ\text{C}$          |
| $T_{STG}$       | Storage Temperature Range  | -65 ~ +150  | $^\circ\text{C}$          |

Stresses exceeding those listed in the Maximum Ratings table may damage the device. If any of these limits are exceeded, device functionality should not be assumed, damage may occur and reliability may be affected.

- Thermal resistance test board:  
Size: 1.6 mm x 76.2 mm x 114.3 mm (1S0P)  
JEDEC Standard: JESD51-3, JESD51-7
- Assume no ambient airflow.
- $T_{JMAX} = 150^\circ\text{C}$ ; Ratings apply to ambient temperature at  $25^\circ\text{C}$ .
- Power dissipation calculation:  $P_D = (T_J - T_A) / R_{\theta JA}$ .

### RECOMMENDED OPERATING RANGES

| Symbol   | Parameter       | Min.      | Max. | Unit |
|----------|-----------------|-----------|------|------|
| $V_{KA}$ | Cathode Voltage | $V_{REF}$ | 36   | V    |
| $I_{KA}$ | Cathode Current | 1         | 100  | mA   |

Functional operation above the stresses listed in the Recommended Operating Ranges is not implied. Extended exposure to stresses beyond the Recommended Operating Ranges limits may affect device reliability.

# KA431S, KA431SA, KA431SL

## ELECTRICAL CHARACTERISTICS (Note 5)

Values are at  $T_A = 25^\circ\text{C}$  unless otherwise noted

| Symbol                         | Parameter   | Conditions  | KA431S  |       |       | KA431SA |       |       | KA431SL |       |       | Unit          |      |
|--------------------------------|---|---|---|-------|-------|---------|-------|-------|---------|-------|-------|---------------|------|
|                                |   |   | Min.  | Typ.  | Max.  | Min.    | Typ.  | Max.  | Min.    | Typ.  | Max.  |               |      |
| $V_{REF}$                      | Reference Input Voltage   | $V_{KA} = V_{REF}, I_{KA} = 10 \text{ mA}$  | 2.450   | 2.500 | 2.550 | 2.470   | 2.495 | 2.520 | 2.482   | 2.495 | 2.508 | V             |      |
| $\Delta V_{REF}/\Delta T$      | Deviation of Reference Input Voltage Over-Temperature                       | $V_{KA} = V_{REF}, I_{KA} = 10 \text{ mA}, T_{MIN} \leq T_A \leq T_{MAX}$               | -   | 4.5   | 17.0  | -       | 4.5   | 17.0  | -       | 4.5   | 17.0  | mV            |      |
| $\Delta V_{REF}/\Delta V_{KA}$ | Ratio of Change in Reference Input Voltage to the Change in Cathode Voltage | $I_{KA} = 10 \text{ mA}$  | $\Delta V_{KA} = 10 \text{ V} - V_{REF}$      | -     | -1.0  | -2.7    | -     | -1.0  | -2.7    | -     | -1.0  | -2.7          | mV/V |
|                                |   |   | $\Delta V_{KA} = 36 \text{ V} - 10 \text{ V}$ | -     | -0.5  | -2.0    | -     | -0.5  | -2.0    | -     | -0.5  | -2.0          |      |
| $I_{REF}$                      | Reference Input Current   | $I_{KA} = 10 \text{ mA}, R1 = 10 \text{ k}\Omega, R2 = \infty$                          | -   | 1.5   | 4.0   | -       | 1.5   | 4.0   | -       | 1.5   | 4.0   | $\mu\text{A}$ |      |
| $\Delta I_{REF}/\Delta T$      | Deviation of Reference Input Current Over Full Temperature Range            | $I_{KA} = 10 \text{ mA}, R1 = 10 \text{ k}\Omega, R2 = \infty, T_A = \text{Full Range}$ | -   | 0.4   | 1.2   | -       | 0.4   | 1.2   | -       | 0.4   | 1.2   | $\mu\text{A}$ |      |
| $I_{KA(MIN)}$                  | Minimum Cathode Current for Regulation                                      | $V_{KA} = V_{REF}$  | -   | 0.45  | 1.00  | -       | 0.45  | 1.00  | -       | 0.45  | 1.00  | mA            |      |
| $I_{KA(OFF)}$                  | Off-Stage Cathode Current   | $V_{KA} = 36 \text{ V}, V_{REF} = 0$  | -   | 0.05  | 1.00  | -       | 0.05  | 1.00  | -       | 0.05  | 1.00  | $\mu\text{A}$ |      |
| $Z_{KA}$                       | Dynamic Impedance   | $V_{KA} = V_{REF}, I_{KA} = 1 \text{ to } 100 \text{ mA}, f \geq 1.0 \text{ kHz}$       | -   | 0.15  | 0.50  | -       | 0.15  | 0.50  | -       | 0.15  | 0.50  | $\Omega$      |      |

Product parametric performance is indicated in the Electrical Characteristics for the listed test conditions, unless otherwise noted. Product performance may not be indicated by the Electrical Characteristics if operated under different conditions.

5.  $T_{MIN} = -25^\circ\text{C}, T_{MAX} = +85^\circ\text{C}$

## TEST CIRCUITS

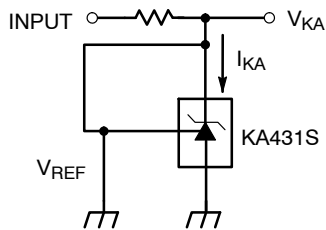

Figure 3. Test Circuit for  $V_{KA} = V_{REF}$

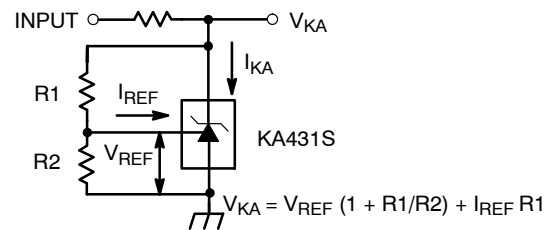

Figure 4. Test Circuit for  $V_{KA} \geq V_{REF}$

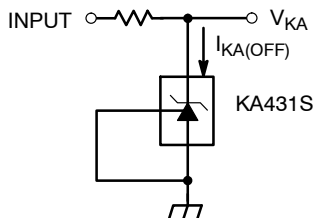

Figure 5. Test Circuit for  $I_{KA(OFF)}$

# KA431S, KA431SA, KA431SL

## TYPICAL APPLICATIONS

$$V_o = \left(1 + \frac{R_1}{R_2}\right) V_{ref}$$

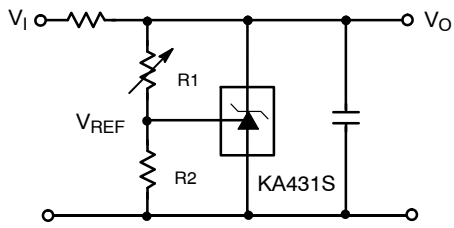

Figure 6. Shunt Regulator

$$V_o = \left(1 + \frac{R_1}{R_2}\right) V_{ref}$$

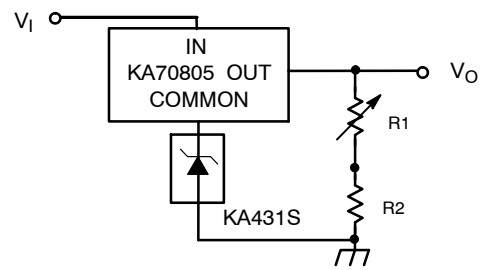

Figure 7. Output Control for Three-Terminal Fixed Regulator

$$V_o = \left(1 + \frac{R_1}{R_2}\right) V_{ref}$$

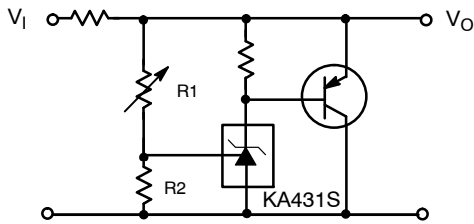

Figure 8. High Current Shunt Regulator

$$I_o = \frac{V_{REF}}{R_{CL}}$$

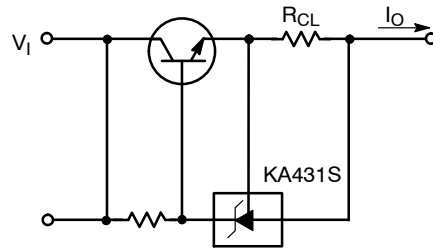

Figure 9. Current limit or Current Source

$$I_o = \frac{V_{REF}}{R_s}$$

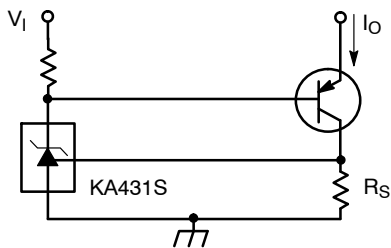

Figure 10. Constant-Current Sink

TYPICAL CHARACTERISTICS

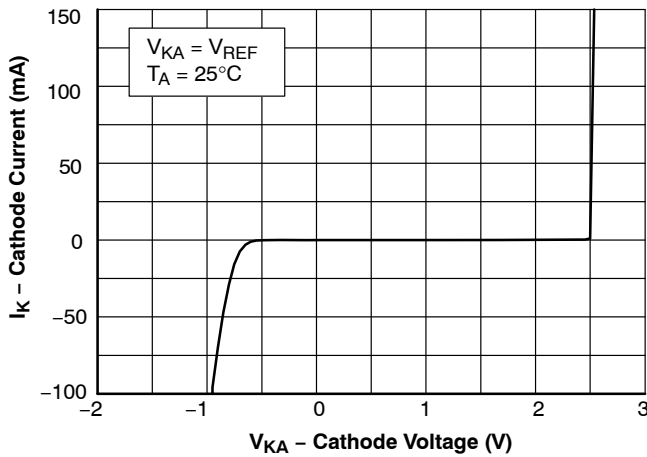

Figure 11. Cathode Current vs. Cathode Voltage

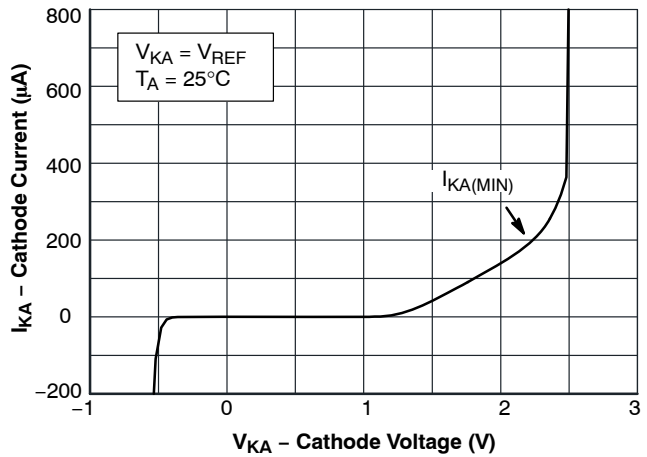

Figure 12. Cathode Current vs. Cathode Voltage

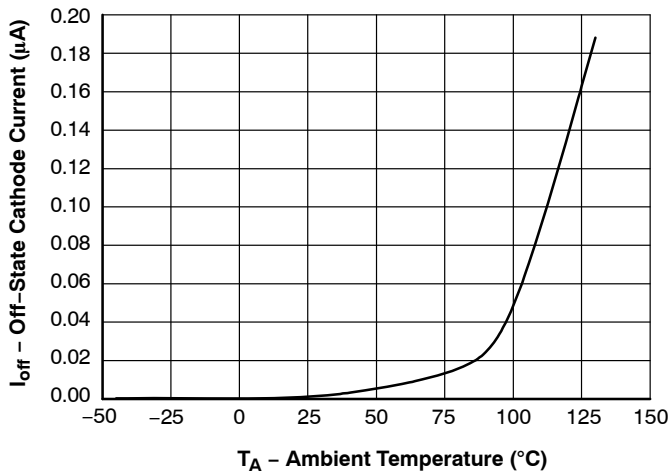

Figure 13. OFF-State Cathode Current vs. Ambient Temperature

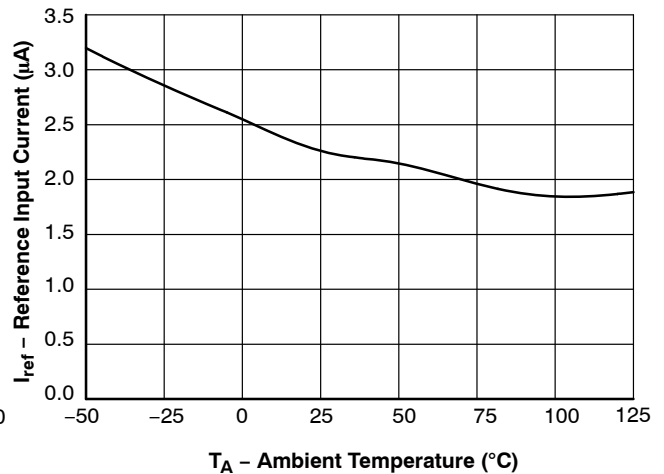

Figure 14. Reference Input Current vs. Ambient Temperature

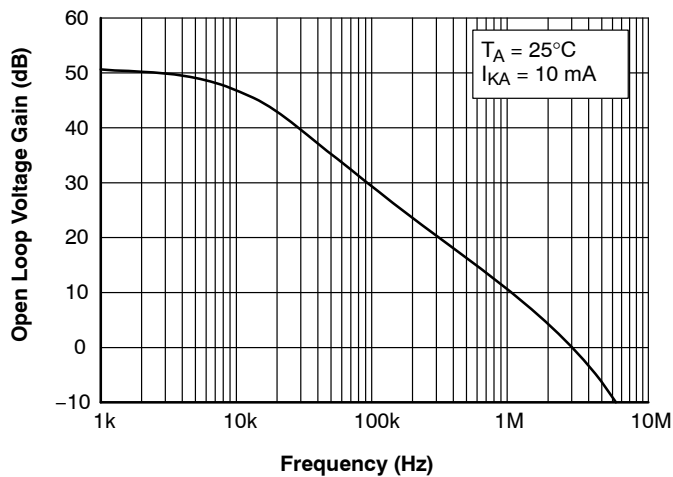

Figure 15. Frequency vs. Small Signal Voltage Amplification

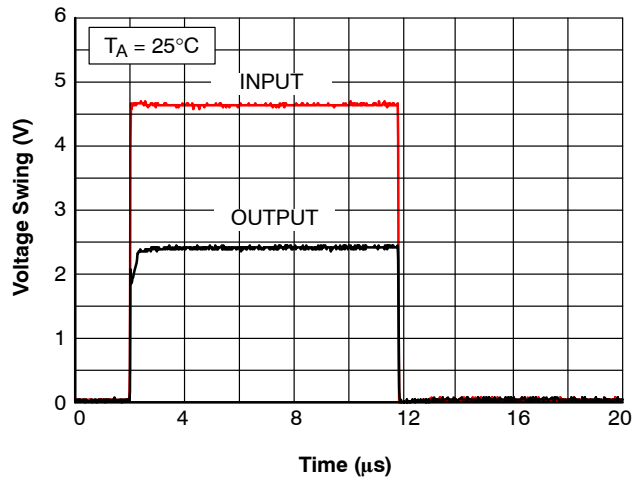

Figure 16. Pulse Response

# KA431S, KA431SA, KA431SL

## TYPICAL CHARACTERISTICS (Continued)

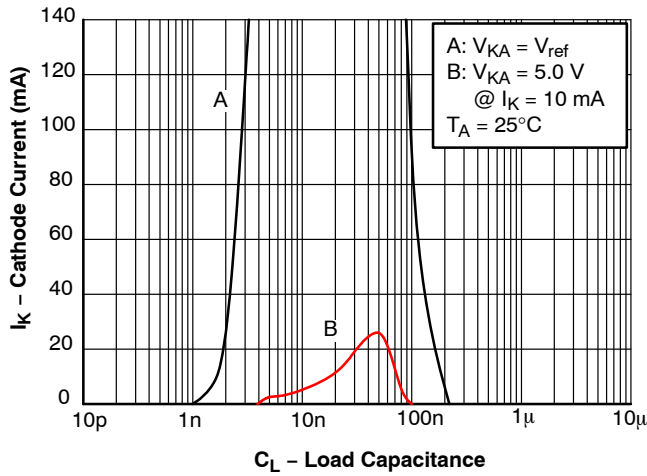

Figure 17. Stability Boundary Conditions

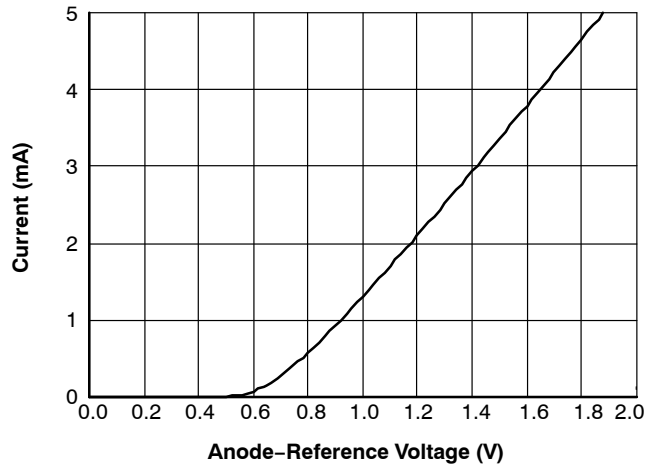

Figure 18. Anode-Reference Diode Curve

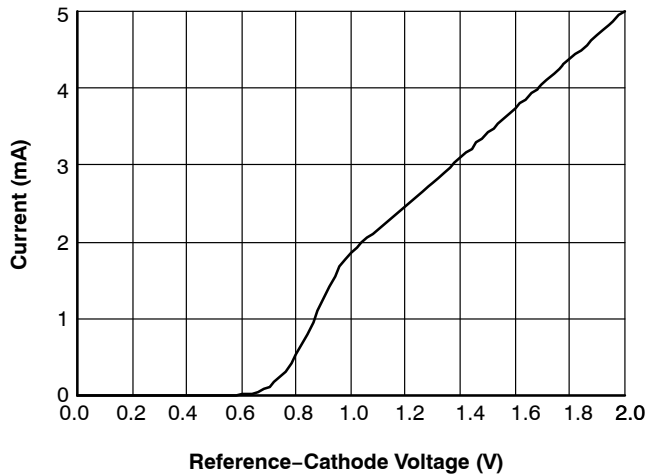

Figure 19. Reference-Cathode Diode Curve

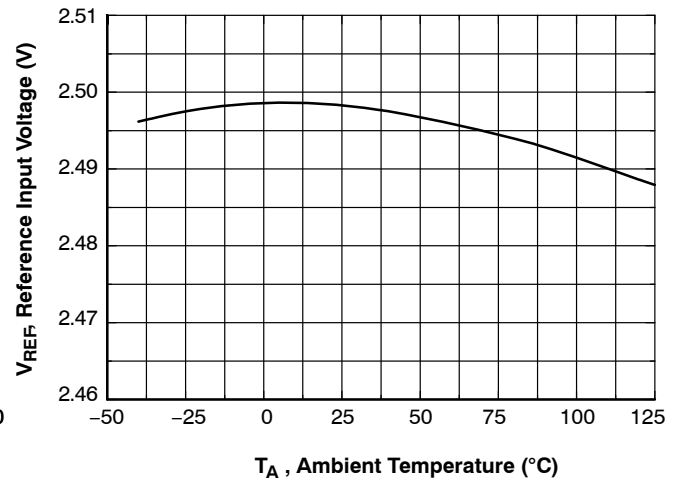

Figure 20. Reference Input Voltage vs. Ambient Temperature

### ORDERING INFORMATION

| Part Number  | Output Voltage Tolerance | Operating Temperature Range | Top Mark | Package                 | Shipping <sup>†</sup> |
|--------------|--------------------------|-----------------------------|----------|-------------------------|-----------------------|
| KA431SMFTF   | 2%                       | -25 to +85°C                | 43A      | SOT23-FL3L<br>(Pb-Free) | 3000 / Tape and Reel  |
| KA431SMF2TF  |                          |                             | 43D      |                         |                       |
| KA431SAMFTF  | 1%                       |                             | 43B      |                         |                       |
| KA431SAMF2TF |                          |                             | 43E      |                         |                       |
| KA431SLMFTF  | 0.5%                     |                             | 43C      |                         |                       |
| KA431SLMF2TF |                          |                             | 43F      |                         |                       |

<sup>†</sup>For information on tape and reel specifications, including part orientation and tape sizes, please refer to our Tape and Reel Packaging Specifications Brochure, [BRD8011/D](#).

# MECHANICAL CASE OUTLINE PACKAGE DIMENSIONS

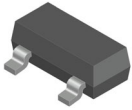

**SOT23-3L**  
**CASE 318AB**  
**ISSUE A**

DATE 14 DEC 2021

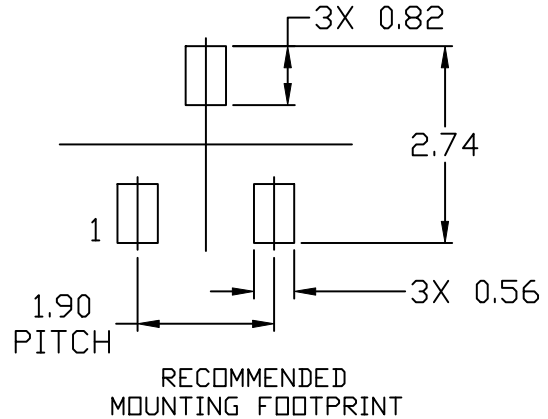
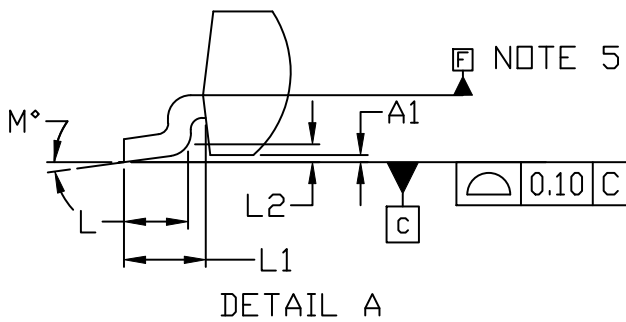
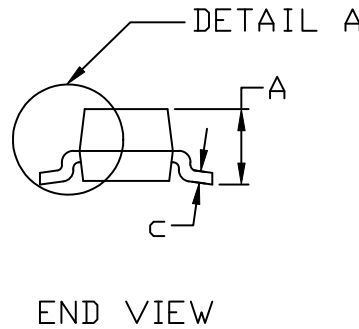
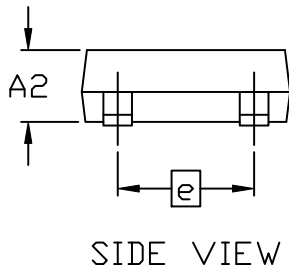
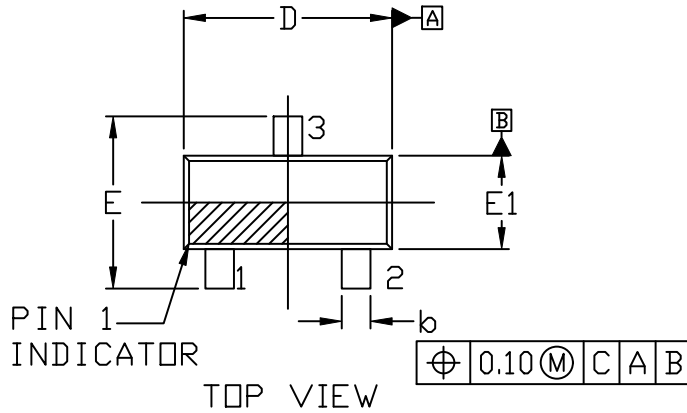

- NOTES:
1. DIMENSIONING AND TOLERANCING PER ASME Y14.5M, 2009.
  2. CONTROLLING DIMENSION: MILLIMETERS
  3. DIMENSION b DOES NOT INCLUDE DAMBAR PROTRUSION. ALLOWABLE PROTRUSION SHALL BE 0.127 mm IN EXCESS OF MAXIMUM MATERIAL CONDITION.
  4. DIMENSIONS D AND E1 DO NOT INCLUDE MOLD FLASH, PROTRUSIONS, OR GATE BURRS. MOLD FLASH, PROTRUSIONS, OR GATE BURRS SHALL NOT EXCEED 0.15 mm PER SIDE. DIMENSIONS D AND E1 ARE DETERMINED AT DATUM F.
  5. DATUMS A AND B ARE TO BE DETERMINED AT DATUM F.
  6. A1 IS DEFINED AS THE VERTICAL DISTANCE FROM THE SEATING PLANE TO THE LOWEST POINT ON THE PACKAGE BODY.
  7. LEAD THICKNESS (c) AND LEAD WIDTH (b) INCLUDE PLATING THICKNESS.

| DIM | MILLIMETERS |      |      |
|-----|-------------|------|------|
|     | MIN.        | NOM. | MAX. |
| A   | ---         | ---  | 1.15 |
| A1  | 0.00        | ---  | 0.10 |
| A2  | 0.90        | 1.00 | 1.10 |
| b   | 0.30        | ---  | 0.50 |
| c   | 0.127 REF   |      |      |
| D   | 2.80        | 2.90 | 3.00 |
| E   | 2.25        | 2.40 | 2.55 |
| E1  | 1.20        | 1.30 | 1.40 |
| e   | 1.90 BSC    |      |      |
| L   | 0.30        | ---  | ---  |
| L1  | 0.55 REF    |      |      |
| L2  | 0.25 REF    |      |      |
| M   | 0°          | ---  | 8°   |

### GENERIC MARKING DIAGRAM\*

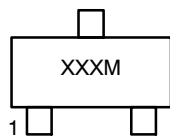

XXX = Specific Device Code  
M = Date Code

\*This information is generic. Please refer to device data sheet for actual part marking. Pb-Free indicator, "G" or microdot "•", may or may not be present. Some products may not follow the Generic Marking.

|                         |                    |  |
|-------------------------|--------------------|--|
| <b>DOCUMENT NUMBER:</b> | <b>98AON27911H</b> | Electronic versions are uncontrolled except when accessed directly from the Document Repository. Printed versions are uncontrolled except when stamped "CONTROLLED COPY" in red. |
| <b>DESCRIPTION:</b>     | <b>SOT23-3L</b>    | <b>PAGE 1 OF 1</b>   |

onsemi and ONSEMI are trademarks of Semiconductor Components Industries, LLC dba onsemi or its subsidiaries in the United States and/or other countries. onsemi reserves the right to make changes without further notice to any products herein. onsemi makes no warranty, representation or guarantee regarding the suitability of its products for any particular purpose, nor does onsemi assume any liability arising out of the application or use of any product or circuit, and specifically disclaims any and all liability, including without limitation special, consequential or incidental damages. onsemi does not convey any license under its patent rights nor the rights of others.

**onsemi**, **Onsemi**, and other names, marks, and brands are registered and/or common law trademarks of Semiconductor Components Industries, LLC dba "**onsemi**" or its affiliates and/or subsidiaries in the United States and/or other countries. **onsemi** owns the rights to a number of patents, trademarks, copyrights, trade secrets, and other intellectual property. A listing of **onsemi**'s product/patent coverage may be accessed at [www.onsemi.com/site/pdf/Patent-Marking.pdf](http://www.onsemi.com/site/pdf/Patent-Marking.pdf). **onsemi** reserves the right to make changes at any time to any products or information herein, without notice. The information herein is provided "as-is" and **onsemi** makes no warranty, representation or guarantee regarding the accuracy of the information, product features, availability, functionality, or suitability of its products for any particular purpose, nor does **onsemi** assume any liability arising out of the application or use of any product or circuit, and specifically disclaims any and all liability, including without limitation special, consequential or incidental damages. Buyer is responsible for its products and applications using **onsemi** products, including compliance with all laws, regulations and safety requirements or standards, regardless of any support or applications information provided by **onsemi**. "Typical" parameters which may be provided in **onsemi** data sheets and/or specifications can and do vary in different applications and actual performance may vary over time. All operating parameters, including "Typicals" must be validated for each customer application by customer's technical experts. **onsemi** does not convey any license under any of its intellectual property rights nor the rights of others. **onsemi** products are not designed, intended, or authorized for use as a critical component in life support systems or any FDA Class 3 medical devices or medical devices with a same or similar classification in a foreign jurisdiction or any devices intended for implantation in the human body. Should Buyer purchase or use **onsemi** products for any such unintended or unauthorized application, Buyer shall indemnify and hold **onsemi** and its officers, employees, subsidiaries, affiliates, and distributors harmless against all claims, costs, damages, and expenses, and reasonable attorney fees arising out of, directly or indirectly, any claim of personal injury or death associated with such unintended or unauthorized use, even if such claim alleges that **onsemi** was negligent regarding the design or manufacture of the part. **onsemi** is an Equal Opportunity/Affirmative Action Employer. This literature is subject to all applicable copyright laws and is not for resale in any manner.

## ADDITIONAL INFORMATION

### TECHNICAL PUBLICATIONS:

Technical Library: [www.onsemi.com/design/resources/technical-documentation](http://www.onsemi.com/design/resources/technical-documentation)  
onsemi Website: [www.onsemi.com](http://www.onsemi.com)

### ONLINE SUPPORT: [www.onsemi.com/support](http://www.onsemi.com/support)

For additional information, please contact your local Sales Representative at [www.onsemi.com/support/sales](http://www.onsemi.com/support/sales)

