

NCP785A

Linear Regulator - Wide Input Voltage Range, Ultra-Low Iq, High PSRR

10 mA

The NCP785A is a high-performance linear regulator, offering a very wide operating input voltage range of up to 450 V DC, with an output current of up to 10 mA.

Ideal for high input voltage applications such as industrial and home metering, home appliances. The NCP785A family offers $\pm 5\%$ initial accuracy, extremely high-power supply rejection ratio and ultra-low quiescent current. The NCP785A is optimized for high-voltage line and load transients, making this part ideal for harsh environment applications.

The NCP785A is offered in fixed output voltage options 3.3 V, 5.0 V, 12 V and 15 V.

SOT-89 package offers good thermal performance and help to minimize the solution size.

Features

- Wide Input Voltage Range:
 - DC: Up to 450 V
 - AC: 85 V to 260 V (half-wave rectifier and 2.2 μF capacitor)
- 10 mA Guaranteed Output Current
- Ultra Low Quiescent Current: Typ. 10 μA ($V_{\text{OUT}} \leq 5 \text{ V}$)
- $\pm 5\%$ Accuracy Over Full Load, Line and Temperature Variations
- Ultra-high PSRR: 70 dB at 60 Hz, 90 dB at 100 kHz
- Stable with Ceramic Output Capacitor 22 μF MLCC
- Thermal Shutdown and Current Limit Protection
- Available in Thermally Enhanced SOT89-3 Package
- This is a Pb-Free Device

Typical Applications

- Industrial Applications, Home Appliances
- Home Metering / Network Application
- Off-line Power Supplies

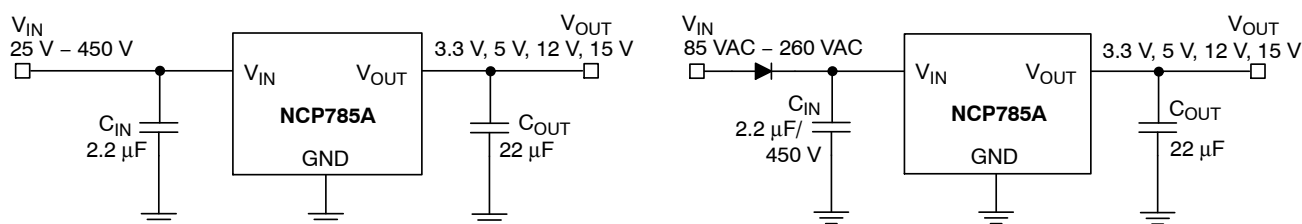

Figure 1. Typical Applications



ON Semiconductor®

www.onsemi.com

MARKING DIAGRAM



SOT-89
CASE 528AG

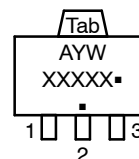

(Top Views)

(Tab is connected to Pin 2)

- A = Assembly Location
- Y = Year
- W = Work Week
- XXXXX = Specific Device Code
- = Pb-Free Package

(Note: Microdot may be in either location)

ORDERING INFORMATION

See detailed ordering and shipping information in the package dimensions section on page 9 of this data sheet.

NCP785A

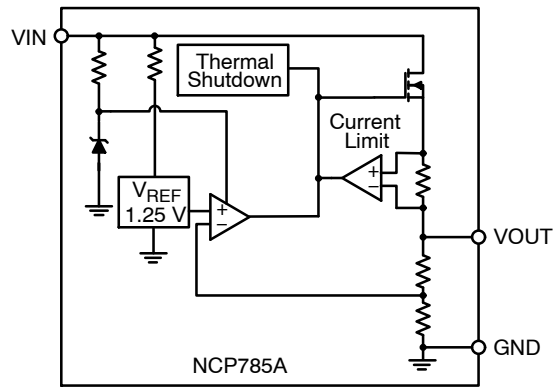

Figure 2. Simplified Internal Block Diagram

Table 1. PIN FUNCTION DESCRIPTION

Pin No. (SOT-89)	Pin Name	Description
1	VIN	Supply Voltage Input. Connect 2.2 μ F capacitor from VIN to GND.
2, Tab	GND	Ground connection.
3	VOUT	Regulator Output. Connect 22 μ F or larger MLCC capacitor from VOUT to GND.

Table 2. ABSOLUTE MAXIMUM RATINGS

Rating	Symbol	Value	Unit
Input Voltage (Note 1)	V_{IN}	-0.3 to 700	V
Output Voltage	V_{OUT}	-0.3 to 18	V
Maximum Junction Temperature	$T_{J(MAX)}$	150	$^{\circ}$ C
Storage Temperature	T_{STG}	-55 to 150	$^{\circ}$ C
ESD Capability, Human Body Model (All pins except HV pin no.1) (Note 2)	ESD_{HBM}	2000	V
ESD Capability, Machine Model (Note 2)	ESD_{MM}	200	V

Stresses exceeding those listed in the Maximum Ratings table may damage the device. If any of these limits are exceeded, device functionality should not be assumed, damage may occur and reliability may be affected.

- Peak 650 V max 1 ms non repeated for 1 s
- This device series incorporates ESD protection and is tested by the following methods:
 - ESD Human Body Model tested per AEC-Q100-002 (EIA/JESD22-A114)
 - ESD Machine Model tested per AEC-Q100-003 (EIA/JESD22-A115)
 - Latch-up Current Maximum Rating tested per JEDEC standard: JESD78.

Table 3. THERMAL CHARACTERISTICS

Rating	Symbol	Value	Unit
Thermal Characteristics, SOT-89 Thermal Resistance, Junction-to-Air	$R_{\theta JA}$	79	$^{\circ}$ C/W

NCP785A

Table 4. ELECTRICAL CHARACTERISTICS, $V_{OUT} = 3.3\text{ V}$ ($-40^{\circ}\text{C} \leq T_J \leq 85^{\circ}\text{C}$; $V_{IN} = 340\text{ V}$; $I_{OUT} = 100\ \mu\text{A}$, $C_{IN} = 2.2\ \mu\text{F}$, $C_{OUT} = 22\ \mu\text{F}$, unless otherwise noted. Typical values are at $T_J = +25^{\circ}\text{C}$.) (Note 3)

Parameter	Test Conditions	Symbol	Min	Typ	Max	Unit
Operating Input Voltage DC		V_{IN}	25		450	V
Output Voltage Accuracy	$T_J = 25^{\circ}\text{C}$, $I_{OUT} = 100\ \mu\text{A}$, $25\text{ V} \leq V_{IN} \leq 450\text{ V}$	V_{OUT}	3.1515	3.3	3.4485	V
	$-40^{\circ}\text{C} \leq T_J \leq 85^{\circ}\text{C}$, $I_{OUT} = 100\ \mu\text{A}$, $25\text{ V} \leq V_{IN} \leq 450\text{ V}$	V_{OUT}	3.135	3.3	3.465	V
Line Regulation	$25\text{ V} \leq V_{IN} \leq 450\text{ V}$, $I_{OUT} = 100\ \mu\text{A}$	Reg_{LINE}	-0.5	0.2	+0.5	%
Load Regulation	$100\ \mu\text{A} \leq I_{OUT} \leq 10\text{ mA}$, $V_{IN} = 35\text{ V}$	Reg_{LOAD}	-1.0	0.6	+1.0	%
Maximum Output Current (Note 4)	$35\text{ V} \leq V_{IN} \leq 450\text{ V}$	I_{OUT}	10.5			mA
Quiescent Current	$I_{OUT} = 0$, $25\text{ V} \leq V_{IN} \leq 450\text{ V}$	I_Q		7.5	14	μA
Ground Current (Note 4)	$25\text{ V} \leq V_{IN} \leq 450\text{ V}$ $0 < I_{OUT} \leq 10\text{ mA}$	I_{GND}			15	μA
Power Supply Rejection Ratio	$V_{IN} = 340\text{ V}_{DC} + 1\text{ V}_{pp}$ modulation, $I_{OUT} = 100\ \mu\text{A}$	$f = 1\text{ kHz}$ PSRR		70		dB
Noise	$f = 100\text{ Hz to } 100\text{ kHz}$ $V_{IN} = 340\text{ V}_{DC}$, $I_{OUT} = 100\ \mu\text{A}$	V_{NOISE}		240		μV_{rms}
Thermal Shutdown Temperature (Note 5)	Temperature increasing from $T_J = +25^{\circ}\text{C}$	T_{SD}		145		$^{\circ}\text{C}$
Thermal Shutdown Hysteresis (Note 5)	Temperature falling from T_{SD}	T_{SDH}	-	10	-	$^{\circ}\text{C}$

Table 5. ELECTRICAL CHARACTERISTICS, $V_{OUT} = 5.0\text{ V}$ ($-40^{\circ}\text{C} \leq T_J \leq 85^{\circ}\text{C}$; $V_{IN} = 340\text{ V}$; $I_{OUT} = 100\ \mu\text{A}$, $C_{IN} = 2.2\ \mu\text{F}$, $C_{OUT} = 22\ \mu\text{F}$, unless otherwise noted. Typical values are at $T_J = +25^{\circ}\text{C}$.) (Note 3)

Parameter	Test Conditions	Symbol	Min	Typ	Max	Unit
Operating Input Voltage DC		V_{IN}	50		450	V
Output Voltage Accuracy	$T_J = 25^{\circ}\text{C}$, $I_{OUT} = 100\ \mu\text{A}$, $50\text{ V} \leq V_{IN} \leq 450\text{ V}$	V_{OUT}	4.775	5.0	5.225	V
	$-40^{\circ}\text{C} \leq T_J \leq 85^{\circ}\text{C}$, $I_{OUT} = 100\ \mu\text{A}$, $50\text{ V} \leq V_{IN} \leq 450\text{ V}$	V_{OUT}	4.75	5.0	5.25	V
Line Regulation	$50\text{ V} \leq V_{IN} \leq 450\text{ V}$, $I_{OUT} = 100\ \mu\text{A}$	Reg_{LINE}	-0.5	0.2	+0.5	%
Load Regulation	$100\ \mu\text{A} \leq I_{OUT} \leq 10\text{ mA}$, $V_{IN} = 55\text{ V}$	Reg_{LOAD}	-1.0	0.62	+1.0	%
Maximum Output Current (Note 4)	$55\text{ V} \leq V_{IN} \leq 450\text{ V}$	I_{OUT}	10.5			mA
Quiescent Current	$I_{OUT} = 0$, $50\text{ V} \leq V_{IN} \leq 450\text{ V}$	I_Q		16	21	μA
Ground Current (Note 4)	$50\text{ V} \leq V_{IN} \leq 450\text{ V}$ $0 < I_{OUT} \leq 10\text{ mA}$	I_{GND}			23	μA
Power Supply Rejection Ratio	$V_{IN} = 340\text{ V}_{DC} + 1\text{ V}_{pp}$ modulation, $I_{OUT} = 100\ \mu\text{A}$	$f = 1\text{ kHz}$ PSRR		70		dB
Noise	$f = 100\text{ Hz to } 100\text{ kHz}$ $V_{IN} = 340\text{ V}_{DC}$, $I_{OUT} = 100\ \mu\text{A}$	V_{NOISE}		300		μV_{rms}
Thermal Shutdown Temperature (Note 5)	Temperature increasing from $T_J = +25^{\circ}\text{C}$	T_{SD}		145		$^{\circ}\text{C}$
Thermal Shutdown Hysteresis (Note 5)	Temperature falling from T_{SD}	T_{SDH}	-	10	-	$^{\circ}\text{C}$

Product parametric performance is indicated in the Electrical Characteristics for the listed test conditions, unless otherwise noted. Product performance may not be indicated by the Electrical Characteristics if operated under different conditions.

3. Performance guaranteed over the indicated operating temperature range by design and/or characterization production tested at $T_J = T_A = 25^{\circ}\text{C}$. Low duty cycle pulse techniques are used during testing to maintain the junction temperature as close to ambient as possible.
4. A proper heatsinking and/or low duty cycle pulse techniques are used to operate the device within the Safe Operating Area.
5. Guaranteed by design

NCP785A

Table 6. ELECTRICAL CHARACTERISTICS, $V_{OUT} = 12\text{ V}$ ($-40^{\circ}\text{C} \leq T_J \leq 85^{\circ}\text{C}$; $V_{IN} = 340\text{ V}$; $I_{OUT} = 100\ \mu\text{A}$, $C_{IN} = 2.2\ \mu\text{F}$, $C_{OUT} = 22\ \mu\text{F}$, unless otherwise noted. Typical values are at $T_J = +25^{\circ}\text{C}$.) (Note 6)

Parameter	Test Conditions	Symbol	Min	Typ	Max	Unit
Operating Input Voltage DC		V_{IN}	55		450	V
Output Voltage Accuracy	$T_J = 25^{\circ}\text{C}$, $I_{OUT} = 100\ \mu\text{A}$, $55\text{ V} \leq V_{IN} \leq 450\text{ V}$	V_{OUT}	11.460	12	12.540	V
	$-40^{\circ}\text{C} \leq T_J \leq 85^{\circ}\text{C}$, $I_{OUT} = 100\ \mu\text{A}$, $55\text{ V} \leq V_{IN} \leq 450\text{ V}$	V_{OUT}	11.4	12	12.6	V
Line Regulation	$55\text{ V} \leq V_{IN} \leq 450\text{ V}$, $I_{OUT} = 100\ \mu\text{A}$	Reg_{LINE}	-0.5	0.1	+0.5	%/V
Load Regulation	$100\ \mu\text{A} \leq I_{OUT} \leq 10\text{ mA}$, $V_{IN} = 65\text{ V}$	Reg_{LOAD}	-1.0	0.66	+1.0	%
Maximum Output Current (Note 7)	$55\text{ V} \leq V_{IN} \leq 450\text{ V}$	I_{OUT}	10.5			mA
Quiescent Current	$I_{OUT} = 0$, $55\text{ V} \leq V_{IN} \leq 450\text{ V}$	I_Q		17	22	μA
Ground Current (Note 7)	$55\text{ V} \leq V_{IN} \leq 450\text{ V}$ $0 < I_{OUT} \leq 10\text{ mA}$	I_{GND}			25	μA
Power Supply Rejection Ratio	$V_{IN} = 340\text{ V}_{DC} + 1\text{ V}_{pp}$ modulation, $I_{OUT} = 100\ \mu\text{A}$	$f = 1\text{ kHz}$ PSRR		70		dB
Noise	$f = 100\text{ Hz}$ to 100 kHz $V_{IN} = 340\text{ V}_{DC}$, $I_{OUT} = 100\ \mu\text{A}$	V_{NOISE}		420		μV_{rms}
Thermal Shutdown Temperature (Note 8)	Temperature increasing from $T_J = +25^{\circ}\text{C}$	T_{SD}		145		$^{\circ}\text{C}$
Thermal Shutdown Hysteresis (Note 8)	Temperature falling from T_{SD}	T_{SDH}	-	10	-	$^{\circ}\text{C}$

Table 7. ELECTRICAL CHARACTERISTICS, $V_{OUT} = 15\text{ V}$ ($-40^{\circ}\text{C} \leq T_J \leq 85^{\circ}\text{C}$; $V_{IN} = 340\text{ V}$; $I_{OUT} = 100\ \mu\text{A}$, $C_{IN} = 2.2\ \mu\text{F}$, $C_{OUT} = 22\ \mu\text{F}$, unless otherwise noted. Typical values are at $T_J = +25^{\circ}\text{C}$.) (Note 6)

Parameter	Test Conditions	Symbol	Min	Typ	Max	Unit
Operating Input Voltage DC		V_{IN}	60		450	V
Output Voltage Accuracy	$T_J = 25^{\circ}\text{C}$, $I_{OUT} = 100\ \mu\text{A}$, $60\text{ V} \leq V_{IN} \leq 450\text{ V}$	V_{OUT}	14.325	15	15.675	V
	$-40^{\circ}\text{C} \leq T_J \leq 85^{\circ}\text{C}$, $I_{OUT} = 100\ \mu\text{A}$, $60\text{ V} \leq V_{IN} \leq 450\text{ V}$	V_{OUT}	14.25	15	15.75	V
Line Regulation	$60\text{ V} \leq V_{IN} \leq 450\text{ V}$, $I_{OUT} = 100\ \mu\text{A}$	Reg_{LINE}	-0.5	0.1	+0.5	%/V
Load Regulation	$100\ \mu\text{A} \leq I_{OUT} \leq 10\text{ mA}$, $V_{IN} = 65\text{ V}$	Reg_{LOAD}	-1.0	0.66	+1.0	%
Maximum Output Current (Note 7)	$65\text{ V} \leq V_{IN} \leq 450\text{ V}$	I_{OUT}	10.5			mA
Quiescent Current	$I_{OUT} = 0$, $60\text{ V} \leq V_{IN} \leq 450\text{ V}$	I_Q		18	22	μA
Ground Current (Note 7)	$60\text{ V} \leq V_{IN} \leq 450\text{ V}$ $0 < I_{OUT} \leq 10\text{ mA}$	I_{GND}			25	μA
Power Supply Rejection Ratio	$V_{IN} = 340\text{ V}_{DC} + 1\text{ V}_{pp}$ modulation, $I_{OUT} = 100\ \mu\text{A}$	$f = 1\text{ kHz}$ PSRR		70		dB
Noise	$f = 100\text{ Hz}$ to 100 kHz $V_{IN} = 340\text{ V}_{DC}$, $I_{OUT} = 100\ \mu\text{A}$	V_{NOISE}		500		μV_{rms}
Thermal Shutdown Temperature (Note 8)	Temperature increasing from $T_J = +25^{\circ}\text{C}$	T_{SD}		145		$^{\circ}\text{C}$
Thermal Shutdown Hysteresis (Note 8)	Temperature falling from T_{SD}	T_{SDH}	-	10	-	$^{\circ}\text{C}$

Product parametric performance is indicated in the Electrical Characteristics for the listed test conditions, unless otherwise noted. Product performance may not be indicated by the Electrical Characteristics if operated under different conditions.

6. Performance guaranteed over the indicated operating temperature range by design and/or characterization production tested at $T_J = T_A = 25^{\circ}\text{C}$. Low duty cycle pulse techniques are used during testing to maintain the junction temperature as close to ambient as possible.
7. A proper heatsinking and/or low duty cycle pulse techniques are used to operate the device within the Safe Operating Area.
8. Guaranteed by design

NCP785A

TYPICAL CHARACTERISTICS

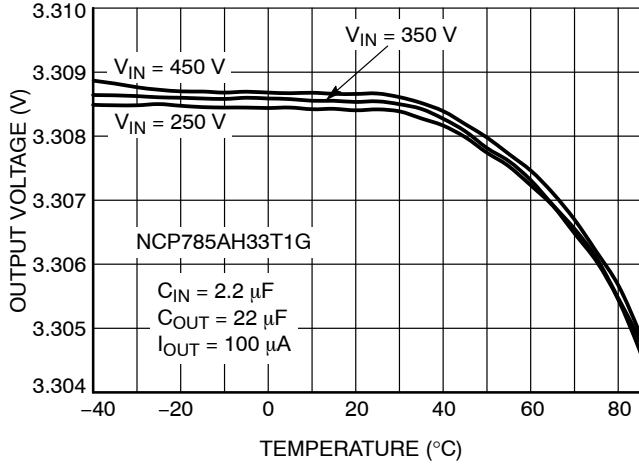

Figure 3. Output Voltage vs. Temperature

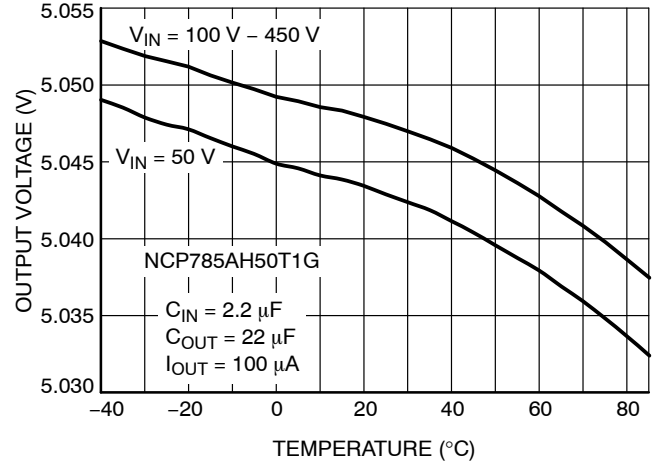

Figure 4. Output Voltage vs. Temperature

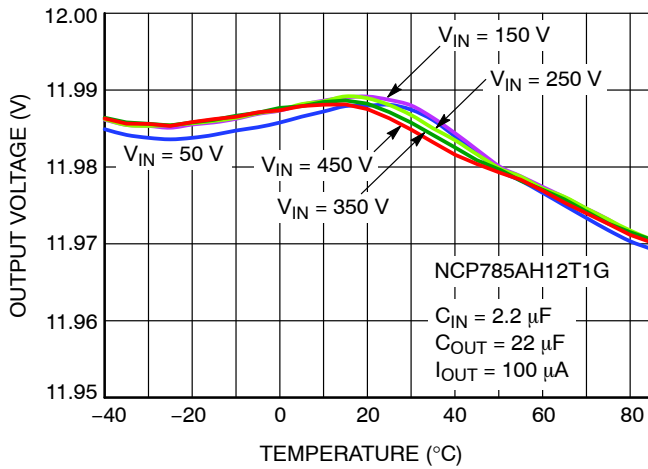

Figure 5. Output Voltage vs. Temperature

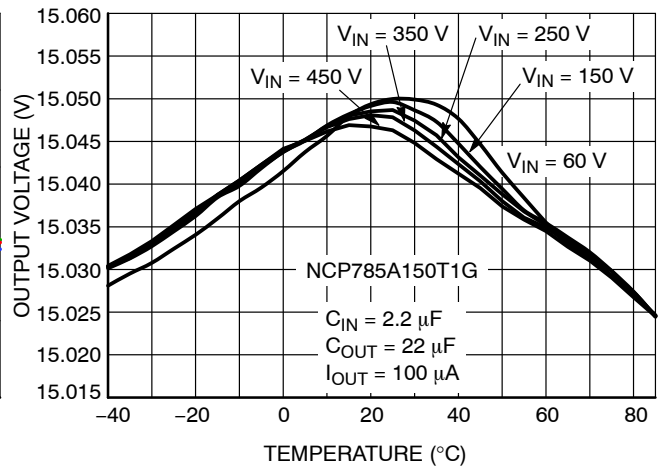

Figure 6. Output Voltage vs. Temperature

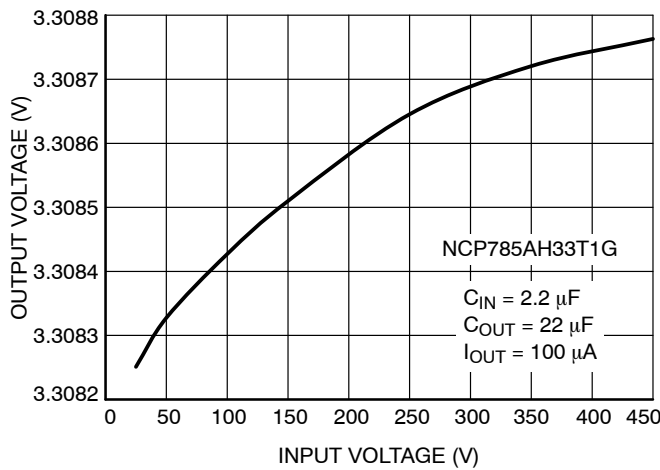

Figure 7. Output Voltage vs. Input Voltage

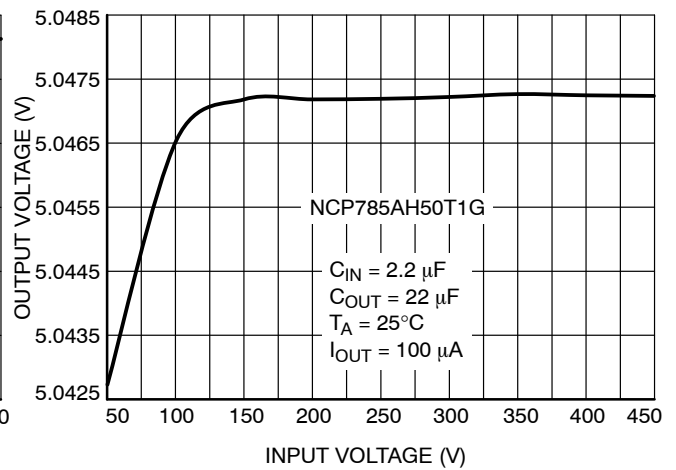

Figure 8. Output Voltage vs. Input Voltage

NCP785A

TYPICAL CHARACTERISTICS

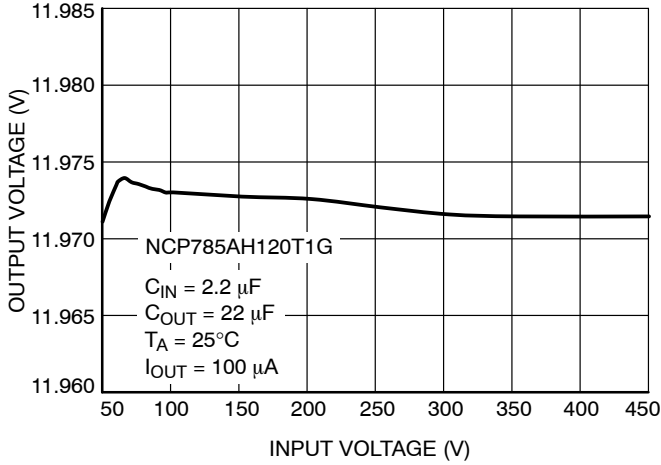

Figure 9. Output Voltage vs. Input Voltage

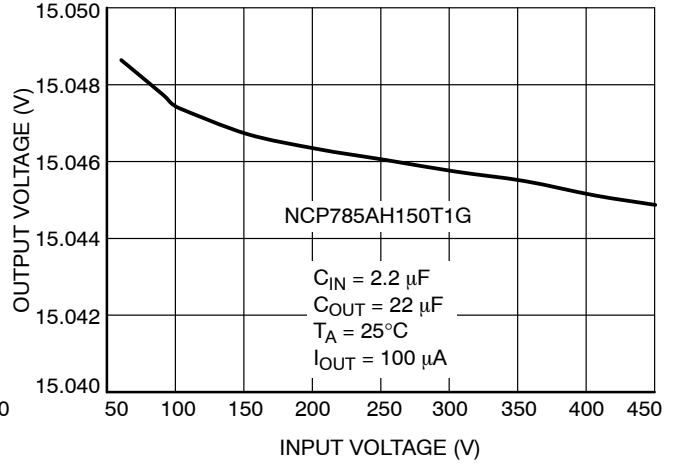

Figure 10. Output Voltage vs. Input Voltage

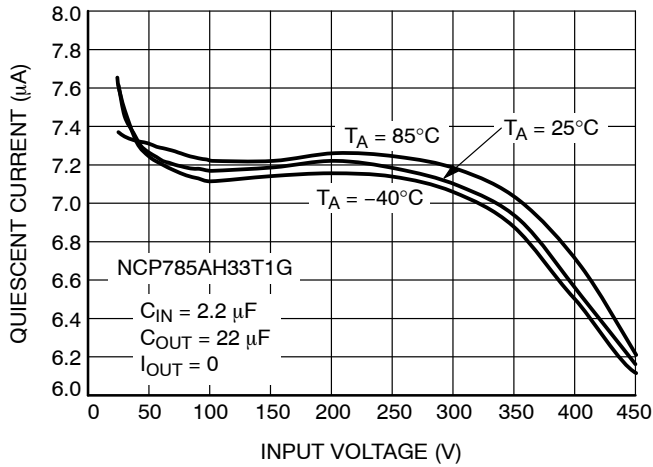

Figure 11. Quiescent Current vs. Input Voltage

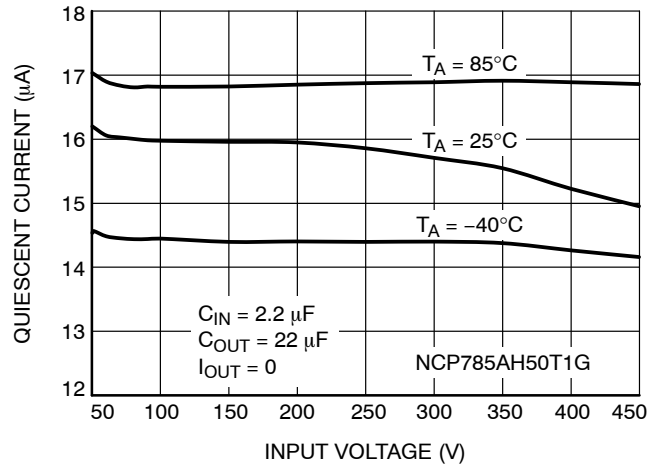

Figure 12. Quiescent Current vs. Input Voltage

NCP785A

TYPICAL CHARACTERISTICS

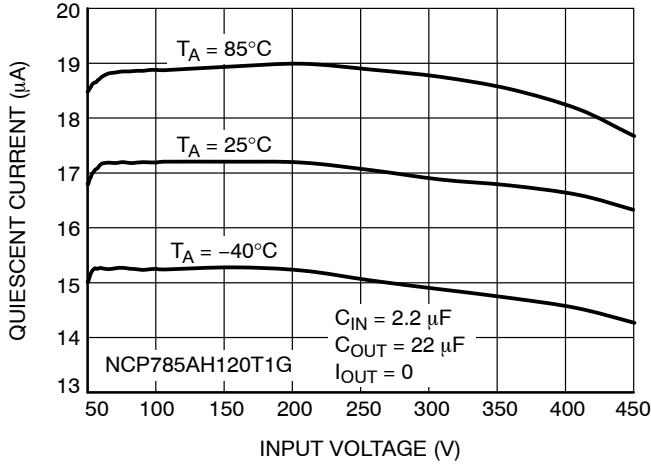

Figure 13. Quiescent Current vs. Input Voltage

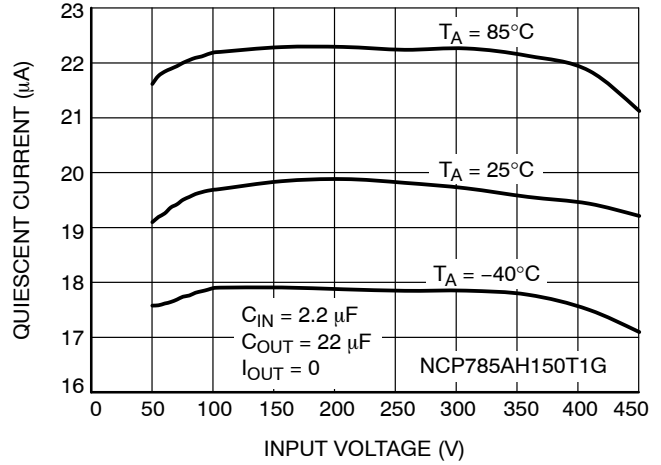

Figure 14. Quiescent Current vs. Input Voltage

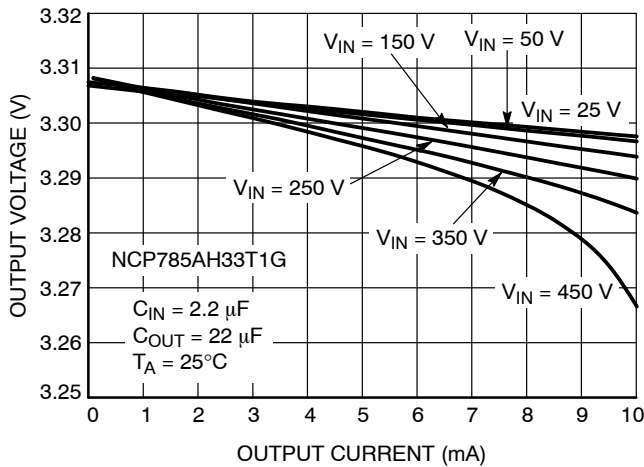

Figure 15. Output Voltage vs. Output Current

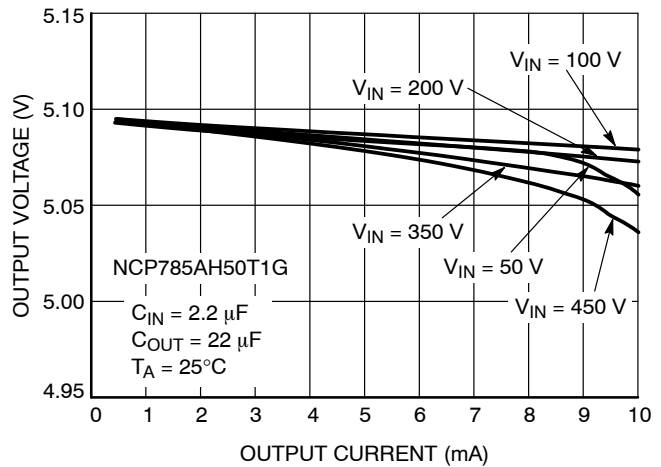

Figure 16. Output Voltage vs. Output Current

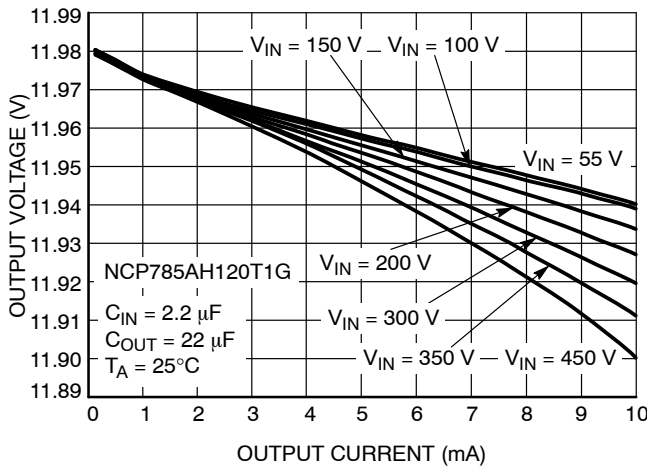

Figure 17. Output Voltage vs. Output Current

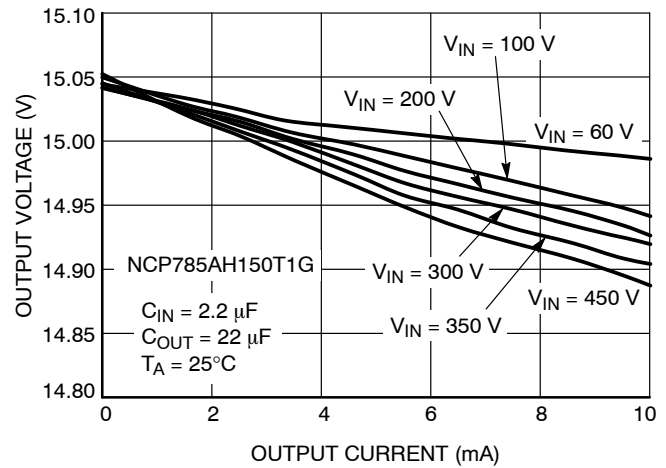

Figure 18. Output Voltage vs. Output Current

NCP785A

TYPICAL CHARACTERISTICS

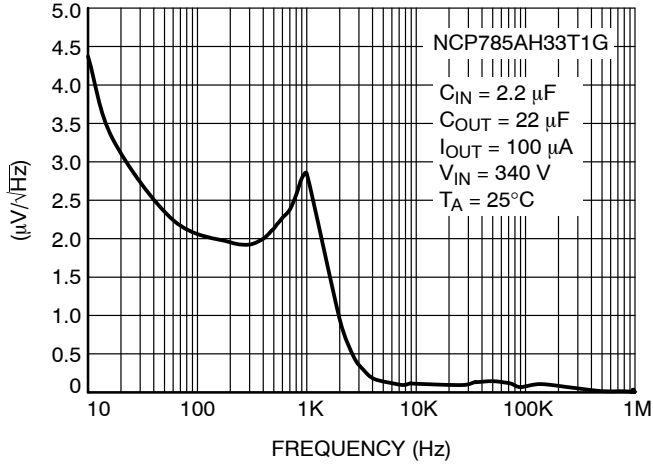

Figure 19. Output Noise Density vs. Frequency

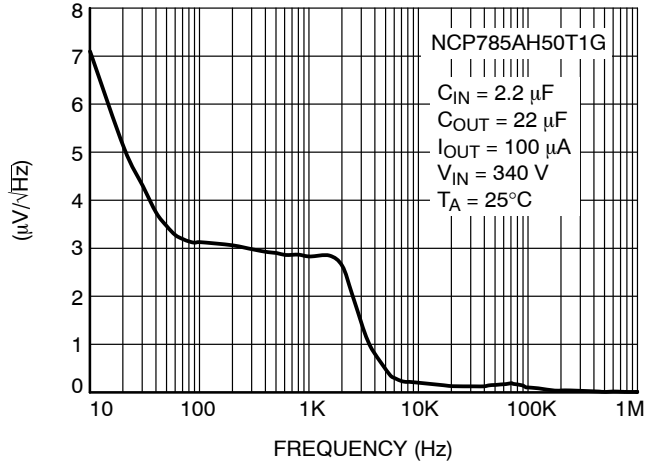

Figure 20. Output Noise Density vs. Frequency

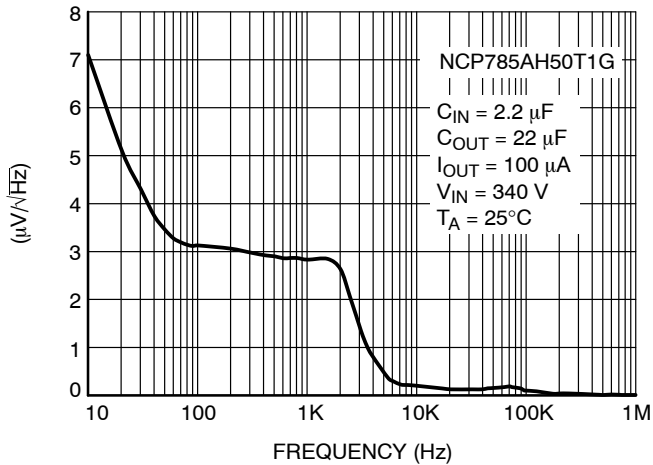

Figure 21. Output Noise Density vs. Frequency

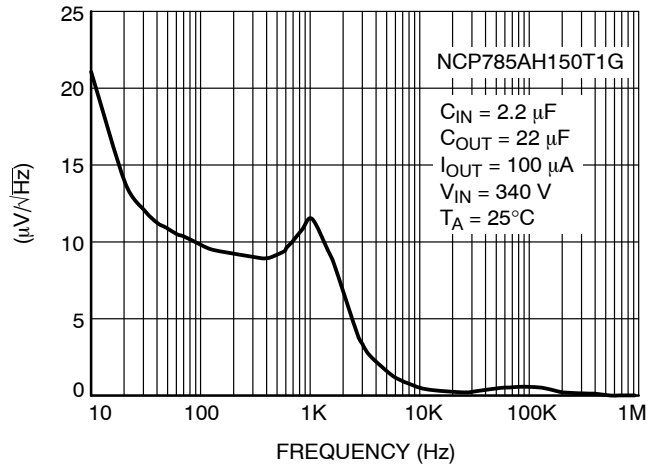

Figure 22. Output Noise Density vs. Frequency

NCP785A

APPLICATION INFORMATION

The typical application circuit for the NCP785A device is shown below.

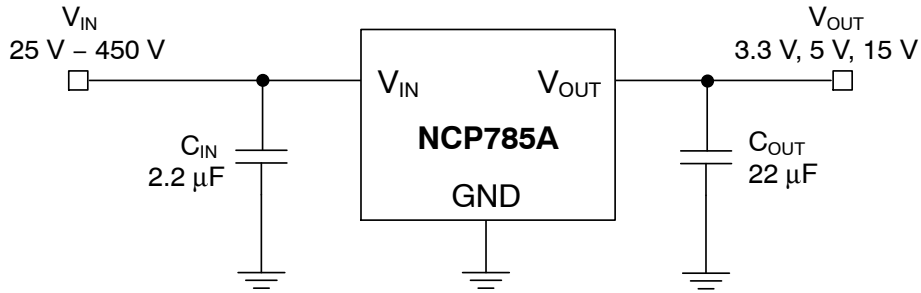

Figure 23. Typical Application Schematic

Input Decoupling (C1)

A 1 μF capacitor either ceramic or electrolytic is recommended and should be connected close to the input pin of NCP785A. Higher value 2.2 μF is necessary to sustain the required minimum input voltage at full load for AC voltage as low as 85 V with half wave rectifier.

Output Decoupling (C2)

The NCP785A Regulator does not require any specific Equivalent Series Resistance (ESR). Thus capacitors exhibiting ESRs ranging from a few $\text{m}\Omega$ up to 0.5 Ω can be used safely. The minimum decoupling value is 22 μF . The regulator accepts ceramic chip capacitors as well as tantalum devices or low ESR electrolytic capacitors. Larger values improve noise rejection and load transient response.

Layout Recommendations

Please be sure the V_{IN} and GND lines are sufficiently wide. When the impedance of these lines is high, there is a chance to pick up noise or to cause the malfunction of regulator.

Set external components, especially the output capacitor, as close as possible to the circuit, and make leads as short as possible.

Thermal

As power across the NCP785A increases, it might become necessary to provide some thermal relief. The maximum power dissipation supported by the device is dependent upon board design layout and used package. Mounting pad configuration on the PCB, the board material, and also the ambient temperature affect the rate of temperature rise for the part. This is stating that when the NCP785A has good thermal conductivity through the PCB, the junction temperature will be relatively low with high power dissipation applications.

ORDERING INFORMATION

Part Number	Output Voltage	Marking	Package	Shipping [†]
NCP785AH33T1G	3.3 V	AA	SOT-89 (Pb-Free)	1000 / Tape & Reel
NCP785AH50T1G	5 V	AC		
NCP785AH120T1G	12 V	AJ		
NCP785AH150T1G	15 V	AD		

[†]For information on tape and reel specifications, including part orientation and tape sizes, please refer to our Tape and Reel Packaging Specifications Brochure, BRD8011/D.

MECHANICAL CASE OUTLINE

PACKAGE DIMENSIONS

ON Semiconductor®



SCALE 2:1

SOT-89, 3 LEAD CASE 528AG ISSUE 0

DATE 04 MAR 2014

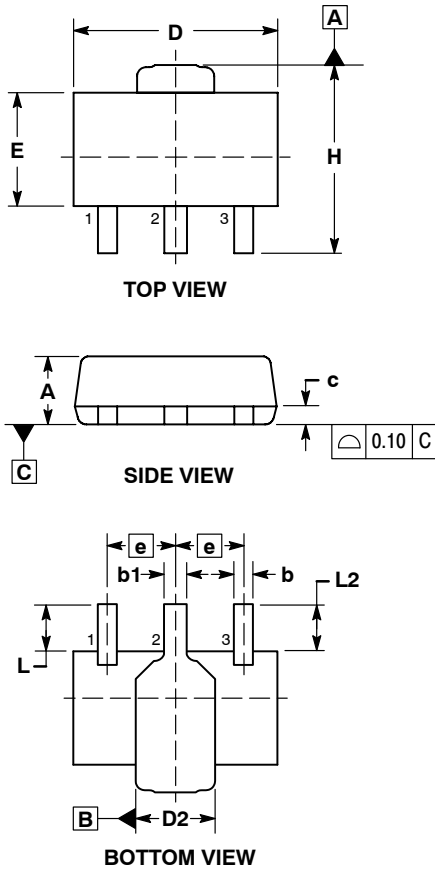

NOTES:

1. DIMENSIONING AND TOLERANCING PER ASME Y14.5M, 1994.
2. CONTROLLING DIMENSION: MILLIMETERS.
3. LEAD THICKNESS INCLUDES LEAD FINISH.
4. DIMENSIONS D AND E DO NOT INCLUDE MOLD FLASH, PROTRUSIONS, OR GATE BURRS.
5. DIMENSIONS L, L2, D2, AND H ARE MEASURED AT DATUM PLANE C.
6. CENTER LEAD CONTOUR MAY VARY WITHIN THE REGION DEFINED BY DIMENSION E.
7. DIMENSION D2 IS DEFINED AT ITS WIDEST POINT.

MILLIMETERS		
DIM	MIN	MAX
A	1.40	1.60
b	0.38	0.47
b1	0.46	0.55
c	0.40	0.44
D	4.40	4.60
D2	1.60	1.90
E	2.40	2.60
e	1.50 BSC	
H	4.05	4.25
L	0.89	1.20

GENERIC MARKING DIAGRAM*

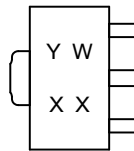

- Y = Year
- W = Work Week
- XX = Specific Device Code

*This information is generic. Please refer to device data sheet for actual part marking. Pb-Free indicator, "G", may or not be present.

RECOMMENDED MOUNTING FOOTPRINT*

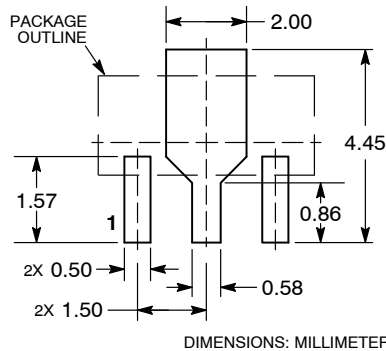

*For additional information on our Pb-Free strategy and soldering details, please download the ON Semiconductor Soldering and Mounting Techniques Reference Manual, SOLDERRM/D.

DOCUMENT NUMBER:	98AON82692F	Electronic versions are uncontrolled except when accessed directly from the Document Repository. Printed versions are uncontrolled except when stamped "CONTROLLED COPY" in red.
DESCRIPTION:	SOT-89, 3 LEAD	PAGE 1 OF 1

ON Semiconductor and are trademarks of Semiconductor Components Industries, LLC dba ON Semiconductor or its subsidiaries in the United States and/or other countries. ON Semiconductor reserves the right to make changes without further notice to any products herein. ON Semiconductor makes no warranty, representation or guarantee regarding the suitability of its products for any particular purpose, nor does ON Semiconductor assume any liability arising out of the application or use of any product or circuit, and specifically disclaims any and all liability, including without limitation special, consequential or incidental damages. ON Semiconductor does not convey any license under its patent rights nor the rights of others.

ON Semiconductor and  are trademarks of Semiconductor Components Industries, LLC dba ON Semiconductor or its subsidiaries in the United States and/or other countries. ON Semiconductor owns the rights to a number of patents, trademarks, copyrights, trade secrets, and other intellectual property. A listing of ON Semiconductor's product/patent coverage may be accessed at www.onsemi.com/site/pdf/Patent-Marking.pdf. ON Semiconductor reserves the right to make changes without further notice to any products herein. ON Semiconductor makes no warranty, representation or guarantee regarding the suitability of its products for any particular purpose, nor does ON Semiconductor assume any liability arising out of the application or use of any product or circuit, and specifically disclaims any and all liability, including without limitation special, consequential or incidental damages. Buyer is responsible for its products and applications using ON Semiconductor products, including compliance with all laws, regulations and safety requirements or standards, regardless of any support or applications information provided by ON Semiconductor. "Typical" parameters which may be provided in ON Semiconductor data sheets and/or specifications can and do vary in different applications and actual performance may vary over time. All operating parameters, including "Typicals" must be validated for each customer application by customer's technical experts. ON Semiconductor does not convey any license under its patent rights nor the rights of others. ON Semiconductor products are not designed, intended, or authorized for use as a critical component in life support systems or any FDA Class 3 medical devices or medical devices with a same or similar classification in a foreign jurisdiction or any devices intended for implantation in the human body. Should Buyer purchase or use ON Semiconductor products for any such unintended or unauthorized application, Buyer shall indemnify and hold ON Semiconductor and its officers, employees, subsidiaries, affiliates, and distributors harmless against all claims, costs, damages, and expenses, and reasonable attorney fees arising out of, directly or indirectly, any claim of personal injury or death associated with such unintended or unauthorized use, even if such claim alleges that ON Semiconductor was negligent regarding the design or manufacture of the part. ON Semiconductor is an Equal Opportunity/Affirmative Action Employer. This literature is subject to all applicable copyright laws and is not for resale in any manner.

PUBLICATION ORDERING INFORMATION

LITERATURE FULFILLMENT:

Email Requests to: orderlit@onsemi.com

ON Semiconductor Website: www.onsemi.com

TECHNICAL SUPPORT

North American Technical Support:
Voice Mail: 1 800-282-9855 Toll Free USA/Canada
Phone: 011 421 33 790 2910

Europe, Middle East and Africa Technical Support:

Phone: 00421 33 790 2910

For additional information, please contact your local Sales Representative