

Features

- Guard Ring Die Construction for Transient Protection
- Low Power Loss, High Efficiency
- Patented Interlocking Clip Design for High Surge Current Capacity
- Low Forward Voltage Drop
- **Lead Free Finish, RoHS Compliant (Note 5)**
- **“Green” Molding Compound (No Br, Sb)**

Mechanical Data

- Case: PowerDI®123
- Case Material: Molded Plastic. UL “Green” Molding Compound
UL Flammability Classification Rating 94V-0
- Moisture Sensitivity: Level 1 per J-STD-020D
- Polarity: Cathode Band
- Terminals: Finish – Matte Tin annealed over Copper leadframe. Solderable per MIL-STD-202, Method 208 ③
- Marking Information: See Page 3
- Ordering Information: See Page 3
- Weight: 0.01 grams (approximate)



Top View

Maximum Ratings @T_A = 25°C unless otherwise specified

Single phase, half wave, 60Hz, resistive or inductive load.
 For capacitance load, derate current by 20%.

Characteristic	Symbol	Value	Unit
Peak Repetitive Reverse Voltage	V _{RRM}	40	V
Working Peak Reverse Voltage	V _{RWM}		
DC Blocking Voltage	V _R		
RMS Reverse Voltage	V _{R(RMS)}	28	V
Average Forward Current @ T _T = 119°C	I _{F(AV)}	1.1	A
Non-Repetitive Peak Forward Surge Current 8.3ms Single Half Sine-Wave Superimposed on Rated Load	I _{FSM}	40	A

Thermal Characteristics

Characteristic	Symbol	Value	Unit
Power Dissipation (Note 1)	P _D	1.67	W
Power Dissipation (Note 2)	P _D	556	mW
Thermal Resistance Junction to Ambient (Note 1)	R _{θJA}	60	°C/W
Thermal Resistance Junction to Ambient (Note 2)	R _{θJA}	180	°C/W
Thermal Resistance Junction to Soldering (Note 3)	R _{θJS}	10	°C/W
Operating Temperature Range	T _J	-55 to +125	°C
Storage Temperature Range	T _{STG}	-55 to +150	°C

Electrical Characteristics @T_A = 25°C unless otherwise specified

Characteristic	Symbol	Min	Typ	Max	Unit	Test Condition
Reverse Breakdown Voltage (Note 4)	V _{(BR)R}	40	—	—	V	I _R = 20μA
Forward Voltage	V _F	—	0.45 0.53	0.51	V	I _F = 0.5A I _F = 1.1A
Leakage Current (Note 4)	I _R	—	—	20 6.0	μA mA	V _R = 40V, T _J = 25°C V _R = 40V, T _J = 100°C
Total Capacitance	C _T	—	28	—	pF	V _R = 10V, f = 1.0MHz

- Notes:
1. Part mounted on 50.8mm X 50.8mm GETEK board with 25.4mm X 25.4mm copper pad, 25% anode, 75% cathode. T_A = 25°C
 2. Part mounted on FR-4 board with 1.8mm X 2.5mm cathode and 1.8mm X 1.2mm anode, 1 oz. copper pads. T_A = 25°C
 3. Theoretical R_{θJS} calculated from the top center of the die straight down to the PCB/cathode tab solder junction.
 4. Short duration pulse test used to minimize self-heating effect.
 5. EU Directive 2002/95/EC (RoHS). All applicable RoHS exemptions applied, see *EU Directive 2002/95/EC Annex Notes*.

PowerDI is a registered trademark of Diodes Incorporated.

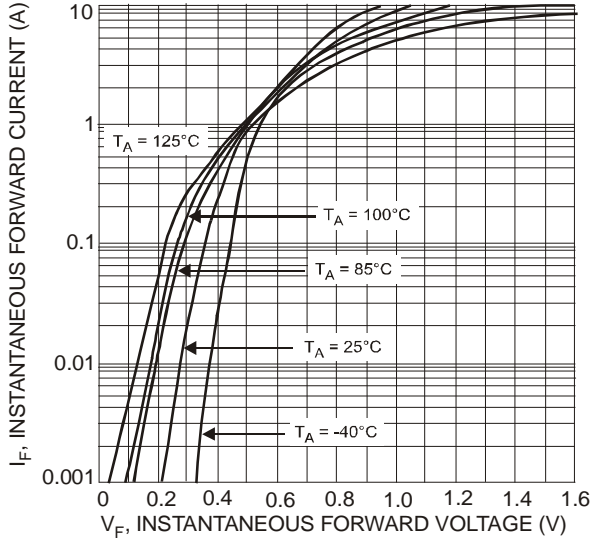

Fig. 1 Typical Forward Characteristics

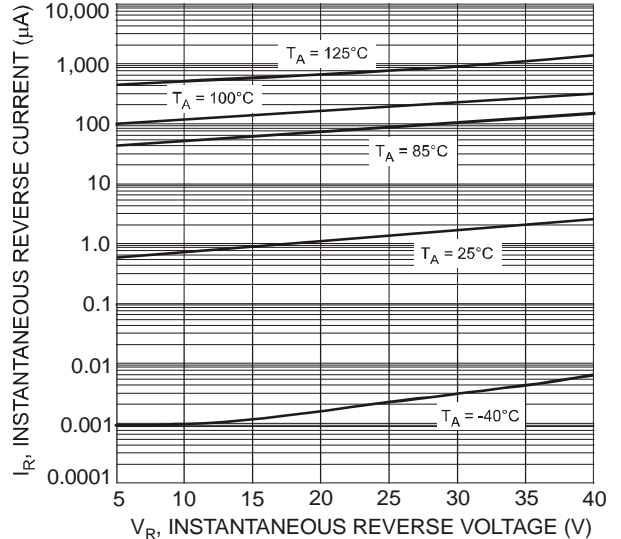

Fig. 2 Typical Reverse Characteristics

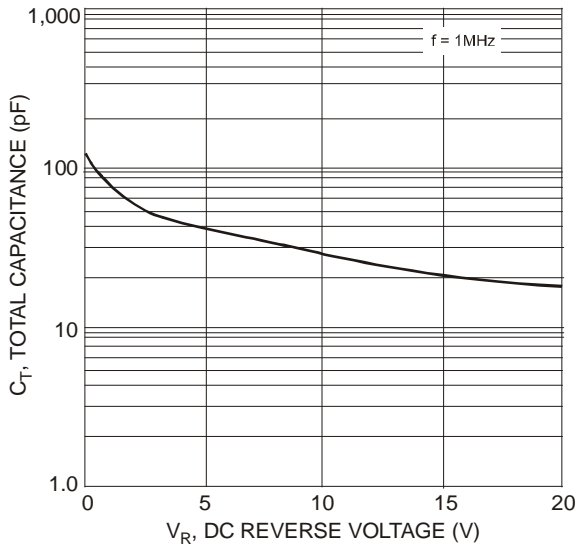

Fig. 3 Total Capacitance vs. Reverse Voltage

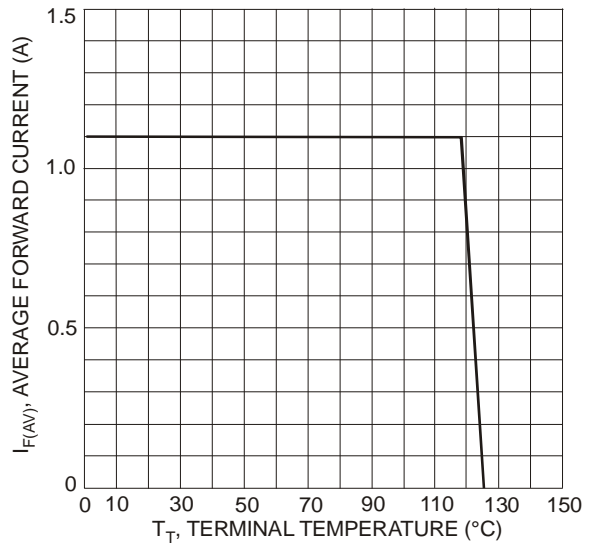

Fig. 4 Forward Current Derating Curve

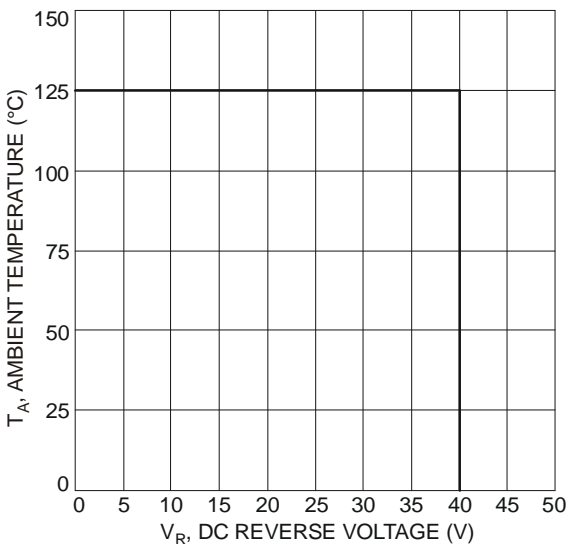

Fig. 5 Operating Temperature Derating

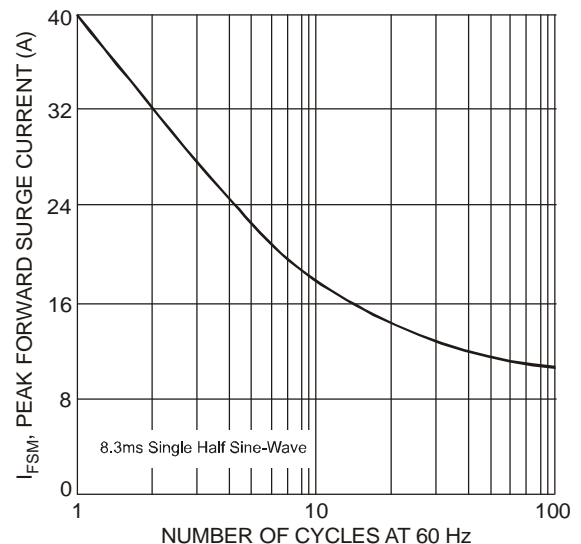
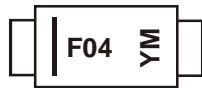

Fig. 6 Maximum Non-Repetitive Peak Forward Surge Current

Ordering Information (Note 6)

Part Number DFLS140-7	Case PowerDI [®] 123	Packaging 3000/Tape & Reel
---------------------------------	---	--------------------------------------

Notes: 6. For packaging details, go to our website at <http://www.diodes.com/datasheets/ap02007.pdf>.

Marking Information

F04 = Product Type Marking Code
 YM = Date Code Marking
 Y = Year (ex: T = 2006)
 M = Month (ex: 9 = September)

Date Code Key

Year	2004	2005	2006	2007	2008	2009	2010	2011	2012
Code	R	S	T	U	V	W	X	Y	Z

Month	Jan	Feb	Mar	Apr	May	Jun	Jul	Aug	Sep	Oct	Nov	Dec
Code	1	2	3	4	5	6	7	8	9	O	N	D

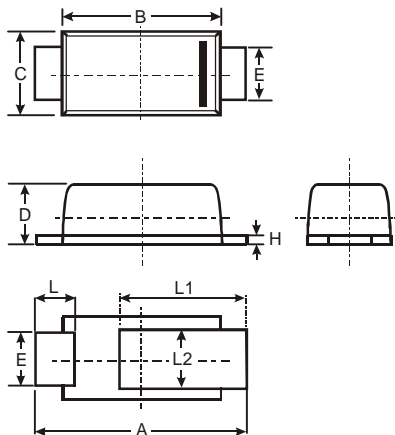
Package Outline Dimensions

PowerDI [®] 123			
Dim	Min	Max	Typ
A	3.50	3.90	3.70
B	2.60	3.00	2.80
C	1.63	1.93	1.78
D	0.93	1.00	0.98
E	0.85	1.25	1.00
H	0.15	0.25	0.20
L	0.55	0.75	0.65
L1	1.80	2.20	2.00
L2	0.95	1.25	1.10
All Dimensions in mm			

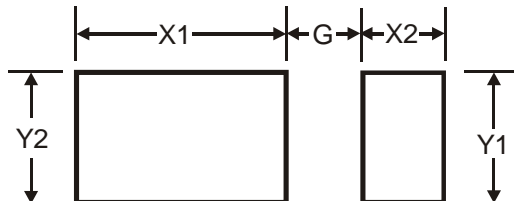
Suggested Pad Layout

Dimensions	Value (in mm)
G	1.0
X1	2.2
X2	0.9
Y1	1.4
Y2	1.4

IMPORTANT NOTICE

Diodes Incorporated and its subsidiaries reserve the right to make modifications, enhancements, improvements, corrections or other changes without further notice to any product herein. Diodes Incorporated does not assume any liability arising out of the application or use of any product described herein; neither does it convey any license under its patent rights, nor the rights of others. The user of products in such applications shall assume all risks of such use and will agree to hold Diodes Incorporated and all the companies whose products are represented on our website, harmless against all damages.

LIFE SUPPORT

Diodes Incorporated products are not authorized for use as critical components in life support devices or systems without the expressed written approval of the President of Diodes Incorporated.

PowerDI is a registered trademark of Diodes Incorporated.