

250mA Low Consumption Linear Regulator

DESCRIPTION

BL8062 series is a group of positive voltage output, low power consumption, low dropout voltage, three terminal regulator. It can provide 200mA output current when input / output voltage differential drops to 418mV ($V_{out}=3.3V$), And it also provides foldback short-circuit protection and output current limit function. The very low power consumption of BL8062 ($I_q=3\mu A$) can greatly improve natural life of batteries.

BL8062 can provide output value in the range of 1.2V~5.0V in 0.1V steps. It also can customized on command.

BL8062 includes high accuracy voltage reference, error amplifier, current limit circuit and output driver module.

BL8062 has well load transient response and good temperature characteristic, And it uses trimming technique to guarantee output voltage accuracy within $\pm 2\%$.

FEATURES

- Low Power Consumption: 3 μA (Typ.)
- Maximum Output Current: 250mA
- Small Dropout Voltage
211mV@100mA ($V_{out}=3.3V$)
418mV@200mA ($V_{out}=3.3V$)
- Input Voltage Range: 2.5V~16V
- Output Voltage Range: 1.2V~5.0V (customized on command in 0.1V steps)
- Highly Accurate: $\pm 2\%$ ($\pm 1\%$ customized)
- Output Current Limit: 500mA
- Foldback Short-circuit Current: 85mA

APPLICATIONS

- Battery Powered equipment
- Power Management of MP3、PDA、DSC、Mouse、PS2 Games
- Reference Voltage Source Regulation after Switching Power

TYPICAL APPLICATION

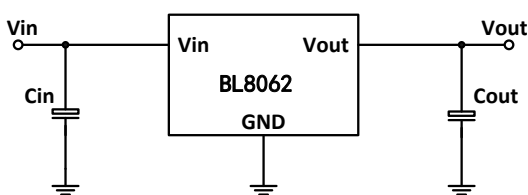

NOTE: Input capacitor ($C_{in}=1\mu F$) and Output capacitor ($C_{out}=1\mu F$) are recommended in all application circuit. Ceramic capacitor is recommended.

ELECTRICAL CHARACTERISTICS

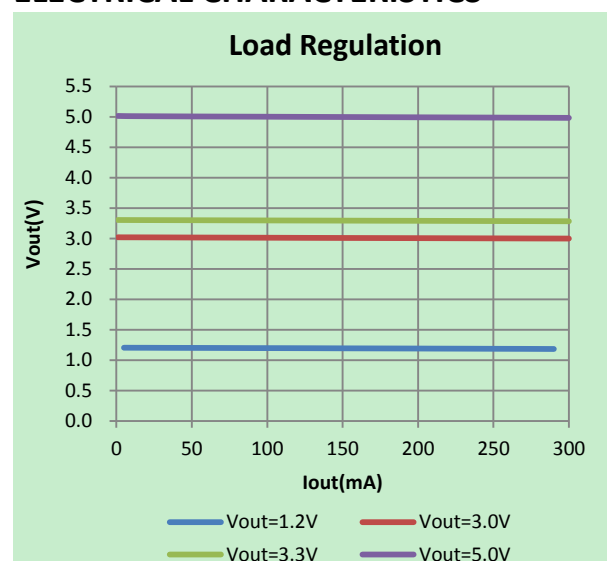

ORDERING INFORMATION

BL8062 ①②③④⑤

Code	Description
①	Temperature&Rohs: C:-40~85°C ,Pb Free Rohs Std.
②	Package type: B3:SOT-23-3 C3:SOT-89-3 C3B:SOT-89-3(B)
③	Packing type: TR:Tape&Reel (Standard)
④	Output voltage: e.g. 12=1.2V 15=1.5V 50=5.0V
⑤	Voltage accuracy: 1= ± 1% Blank(default)= ± 2%

PIN CONFIGURATION

Product Classification		BL8062CB3TR□□□
Marking		SOT-23-3
DXYW	D:Product Code	
	X:Output Voltage	
	YW: Date Code	
Product Classification		BL8062CC3TR□□□
Marking		SOT-89-3
AAXX LLBYW	AA:Product Code	
	XX: Output Voltage	
	LL: LOT NO.	
	B:FAB Code	
	YW: Date Code	
Product Classification		BL8062CC3BTR□□□
Marking		SOT-89-3
AAXXI LLBYW	AA:Product Code	
	XX: Output Voltage	
	LL: LOT NO.	
	B:FAB Code	
	YW: Date Code	

Y: The Year of manufacturing, "1" stands for year 2011, "2" stands for year 2012, and "8" stands for year 2018.
W: The week of manufacturing. "A" stands for week 1, "Z" stands for week 26, "A" stands for week 27, "Z" stands for week 52.

ABSOLUTE MAXIMUM RATING

Parameter	Value	
Max Input Voltage	20V	
Operating Junction Temperature(Tj)	125°C	
Ambient Temperature(Ta)	-40°C -85°C	
Power Dissipation	SOT-23-3	250mW
	SOT-89-3	500mW
Storage Temperature(Ts)	-40°C -150°C	
Lead Temperature & Time	260°C,10S	

Note:

Exceed these limits to damage to the device.
Exposure to absolute maximum rating conditions may affect device reliability.

RECOMMENDED WORK CONDITIONS

Item	Min	Recom- mended	Max.	Unit
Input Voltage Range			16	V
Ambient Temperature	-40		85	°C

ELECTRICAL CHARACTERISTICS

(Test Conditions: $C_{in}=1\mu F$, $C_{out}=1\mu F$, $T_A=25^{\circ}C$, Unless Otherwise Specified)

Symbol	Parameter	Conditions	Min	Type	Max	Units
V_{in}	Input Voltage				16	V
V_{out}	Output Voltage		$V_{out} \times 0.98$		$V_{out} \times 1.02$	V
$I_{out(Max.)}$	Maximum Output Current	$V_{in}-V_{out}=1V$	250			mA
Dropout Voltage	Input-Output Voltage Differential	$I_{out}=100mA$ $V_{out} = 3.3V$		210	400	mV
$\frac{\Delta V_{out}}{\Delta V_{in} \cdot V_{out}}$	Line Regulation	$I_{out}=10mA$ $2V \leq V_{in} \leq 16V$		0.2	0.3	%/V
ΔV_{out}	Load Regulation	$V_{in} = \text{Set } V_{out} + 1V$ $1mA \leq I_{out} \leq 100mA$		20	40	mV
I_q	Quiescent Current	$V_{in} = \text{Set } V_{out} + 1V$		3		μA
$\frac{\Delta V_{out}}{\Delta T \cdot V_{out}}$	Output Voltage Temperature Coefficient	$I_{out}=10mA$		100		ppm/ $^{\circ}C$

BLOCK DIAGRAM

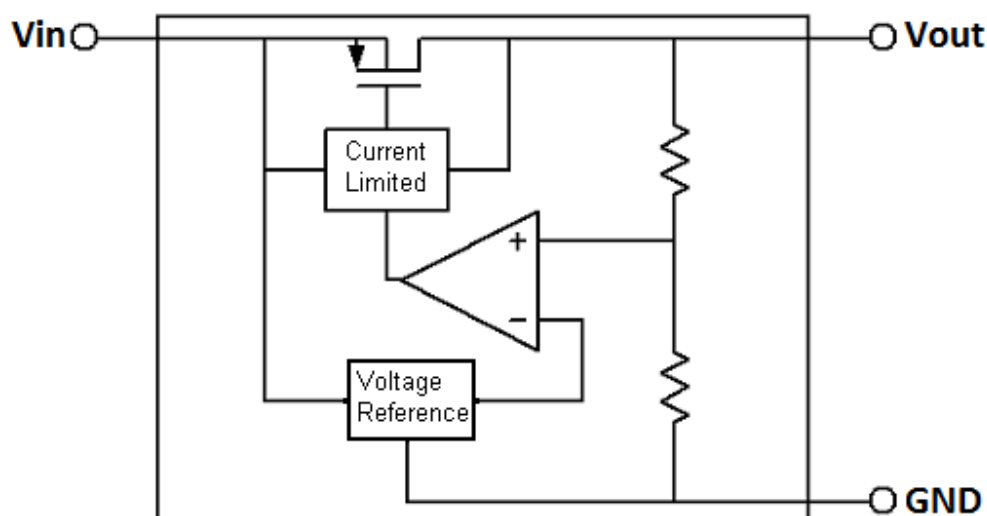

EXPLANATION

BL8062 is a series of low dropout voltage and low power consumption three pins regulator. Its application circuit is very simple, which only needs two outside capacitors. It is composed of these modules: high accuracy voltage reference, current limit circuit, error amplifier, output driver and power transistor.

Current Limit module can keep chip and power system away from danger when load current is more than 500mA.

BL8062 uses trimming technique to assure the accuracy of output value within $\pm 2\%$, at the same time, temperature compensation is elaborately considered in this chip, which makes BL8062's temperature coefficient within 100ppm/ $^{\circ}C$.

TYPICAL PERFORMANCE CHARACTERISTICS

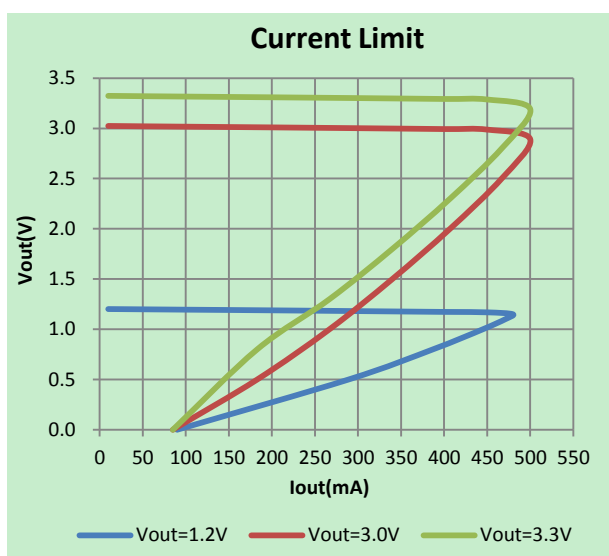
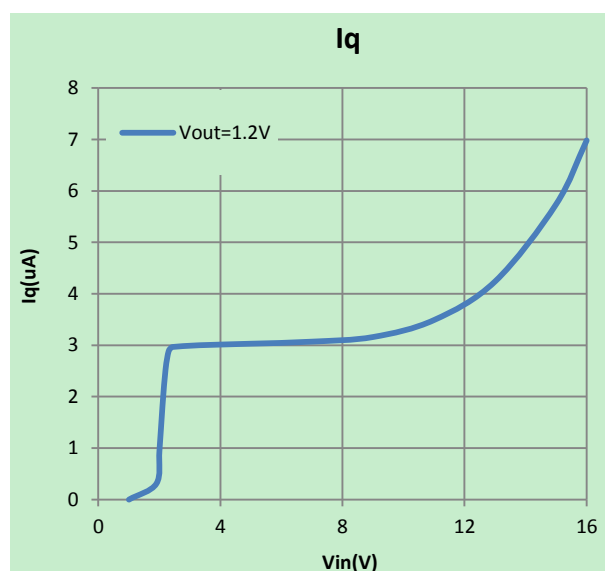
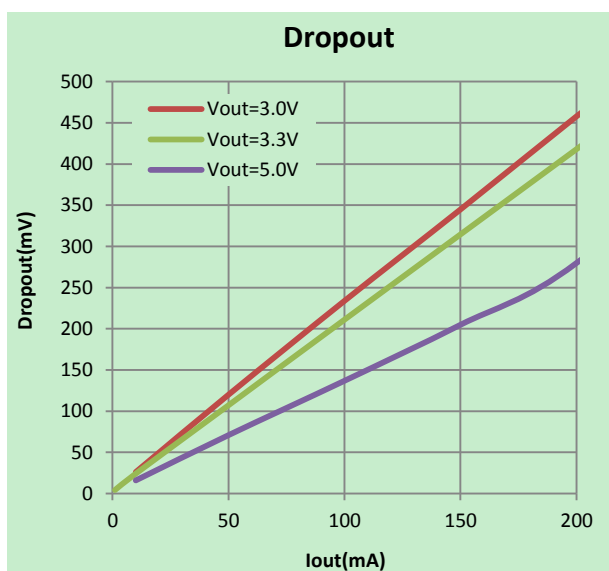
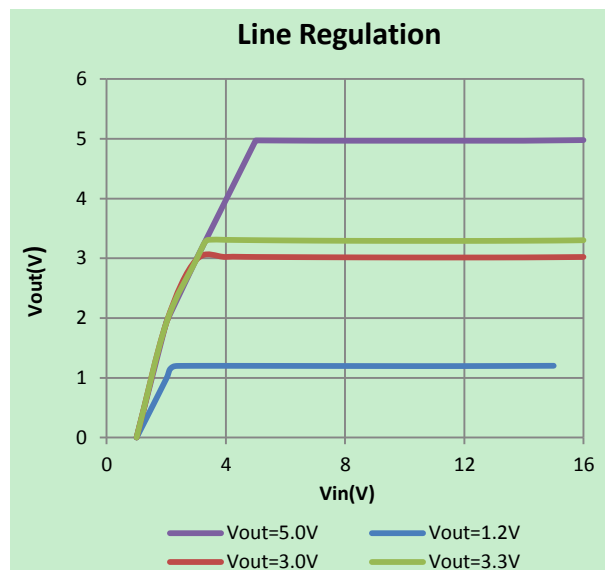
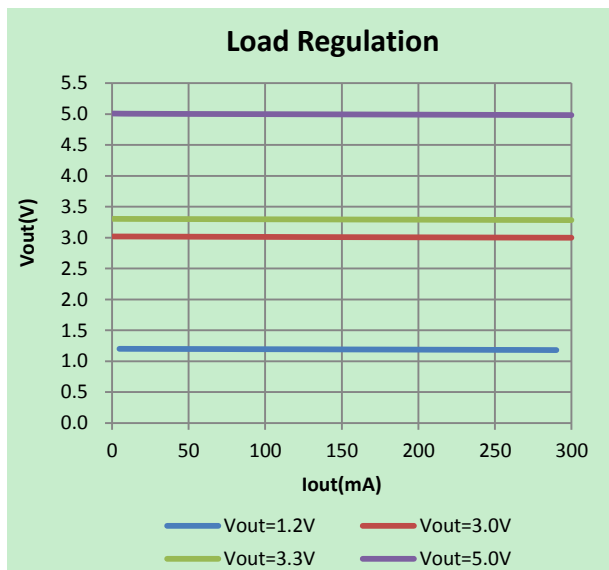

Line transient response

Vin=11V~12V, Ch1—Vin, Ch2—Vout

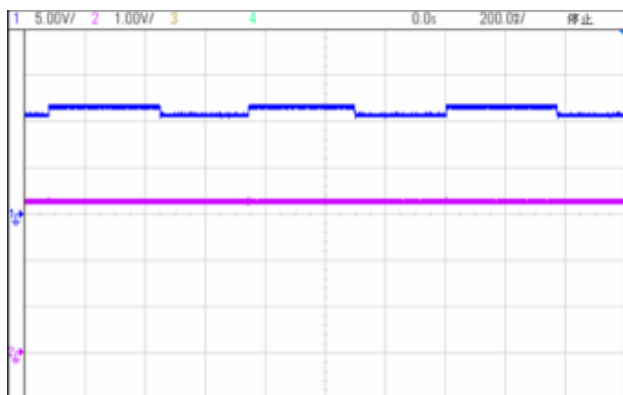

Load transient response

Iout=1mA~100mA, Ch2—Vout, Ch4—Iout

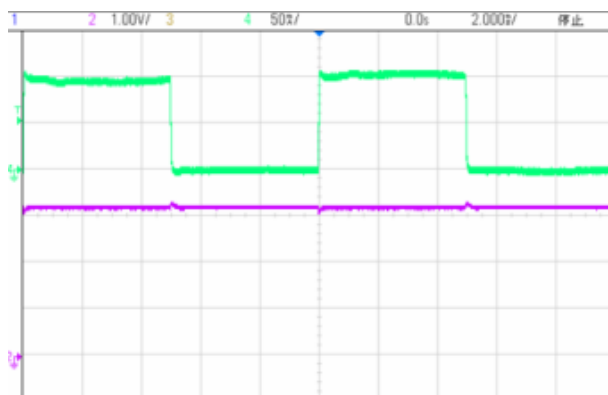

PACKAGE LINE

Package	SOT-23-3	Devices per reel	3000Pcs	Unit	mm
Package dimension:					
<p>Technical drawing of the SOT-23-3 package. The top view shows a rectangular body with a width of 2.9 ± 0.2 mm and a length of 1.9 ± 0.2 mm. The distance between the two side leads (1 and 2) is 1.9 ± 0.2 mm, with each lead offset by 0.95 mm from the center. The distance from the center to the third lead (3) is 0.4 ± 0.1 mm. The body height is 1.6 ± 0.2 mm, and the total height including the lead is 2.8 ± 0.3 mm. The side view shows a lead height of 1.4 mm maximum, a lead width of 1.1 mm with a tolerance of $+0.2$ to -0.1 mm, a lead thickness of 0.8 mm, a lead angle of 0 to 0.1 degrees, and a lead tip thickness of 0.2 mm minimum. The bottom view shows a lead width of 0.16 mm with a tolerance of $+0.1$ to -0.06 mm.</p>					

Package	SOT-89-3	Devices per reel	1000Pcs	Unit	mm
Package Dimension:					
<p>Technical drawing of the SOT-89-3 package. The top view shows a rectangular body with a width of 4.5 ± 0.1 mm and a length of 1.6 ± 0.2 mm. The distance between the two side leads (1 and 2) is 1.6 ± 0.2 mm. The body height is 2.5 ± 0.1 mm, and the total height including the lead is 4.25 mm maximum. The lead height is 0.4 mm, and the lead thickness is 0.8 mm minimum. The side view shows a lead width of 1.5 ± 0.1 mm, a lead thickness of 0.4 ± 0.1 mm, and a lead angle of 0.4 ± 0.1 degrees. The bottom view shows a lead width of 0.42 ± 0.2 mm, a lead thickness of 0.47 ± 0.1 mm, and a lead angle of 1.5 ± 0.1 degrees.</p>					