

# ON Semiconductor

## Is Now

The logo for onsemi, featuring the word "onsemi" in a dark teal, lowercase, sans-serif font. The letter "i" is stylized with a white dot and a teal vertical bar. A small orange triangle is positioned above the top right of the "i". A trademark symbol (TM) is located to the right of the logo.

To learn more about onsemi™, please visit our website at  
[www.onsemi.com](http://www.onsemi.com)

---

**onsemi** and **onsemi** and other names, marks, and brands are registered and/or common law trademarks of Semiconductor Components Industries, LLC dba "**onsemi**" or its affiliates and/or subsidiaries in the United States and/or other countries. **onsemi** owns the rights to a number of patents, trademarks, copyrights, trade secrets, and other intellectual property. A listing of **onsemi** product/patent coverage may be accessed at [www.onsemi.com/site/pdf/Patent-Marking.pdf](http://www.onsemi.com/site/pdf/Patent-Marking.pdf). **onsemi** reserves the right to make changes at any time to any products or information herein, without notice. The information herein is provided "as-is" and **onsemi** makes no warranty, representation or guarantee regarding the accuracy of the information, product features, availability, functionality, or suitability of its products for any particular purpose, nor does **onsemi** assume any liability arising out of the application or use of any product or circuit, and specifically disclaims any and all liability, including without limitation special, consequential or incidental damages. Buyer is responsible for its products and applications using **onsemi** products, including compliance with all laws, regulations and safety requirements or standards, regardless of any support or applications information provided by **onsemi**. "Typical" parameters which may be provided in **onsemi** data sheets and/or specifications can and do vary in different applications and actual performance may vary over time. All operating parameters, including "Typicals" must be validated for each customer application by customer's technical experts. **onsemi** does not convey any license under any of its intellectual property rights nor the rights of others. **onsemi** products are not designed, intended, or authorized for use as a critical component in life support systems or any FDA Class 3 medical devices or medical devices with a same or similar classification in a foreign jurisdiction or any devices intended for implantation in the human body. Should Buyer purchase or use **onsemi** products for any such unintended or unauthorized application, Buyer shall indemnify and hold **onsemi** and its officers, employees, subsidiaries, affiliates, and distributors harmless against all claims, costs, damages, and expenses, and reasonable attorney fees arising out of, directly or indirectly, any claim of personal injury or death associated with such unintended or unauthorized use, even if such claim alleges that **onsemi** was negligent regarding the design or manufacture of the part. **onsemi** is an Equal Opportunity/Affirmative Action Employer. This literature is subject to all applicable copyright laws and is not for resale in any manner. Other names and brands may be claimed as the property of others.



ON Semiconductor®

# J211 / MMBFJ211 N-Channel RF Amplifier

## Description

This device is designed for HF/VHF mixer/amplifier and applications where process 50 is not adequate. Sufficient gain and low-noise for sensitive receivers. Sourced from process 90.

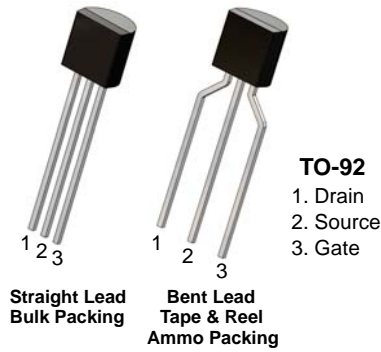

Figure 1. J211 Device Package

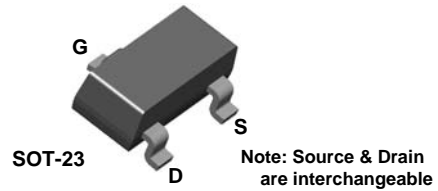

Figure 2. MMBFJ211 Device Package

## Ordering Information

| Part Number | Top Mark | Package   | Packing Method |
|-------------|----------|-----------|----------------|
| J211-D74Z   | J211     | TO-92 3L  | Ammo           |
| MMBFJ211    | 62W      | SOT-23 3L | Tape and Reel  |

### Absolute Maximum Ratings<sup>(1), (2)</sup>

Stresses exceeding the absolute maximum ratings may damage the device. The device may not function or be operable above the recommended operating conditions and stressing the parts to these levels is not recommended. In addition, extended exposure to stresses above the recommended operating conditions may affect device reliability. The absolute maximum ratings are stress ratings only. Values are at  $T_A = 25^\circ\text{C}$  unless otherwise noted.

| Symbol         | Parameter  | Value      | Unit             |
|----------------|--|------------|------------------|
| $V_{DG}$       | Drain-Gate Voltage                               | 25         | V                |
| $V_{GS}$       | Gate-Source Voltage                              | -25        | V                |
| $I_{GF}$       | Forward Gate Current                             | 10         | mA               |
| $T_J, T_{STG}$ | Operating and Storage Junction Temperature Range | -55 to 150 | $^\circ\text{C}$ |

**Notes:**

1. These ratings are based on a maximum junction temperature of  $150^\circ\text{C}$ .
2. These are steady-state limits. ON Semiconductor should be consulted on applications involving pulsed or low-duty-cycle operations.

### Thermal Characteristics

Values are at  $T_A = 25^\circ\text{C}$  unless otherwise noted.

| Symbol          | Parameter                               | Max.                |                         | Unit                      |
|-----------------|---|---------------------|-------------------------|---------------------------|
|                 |   | J211 <sup>(3)</sup> | MMBFJ211 <sup>(3)</sup> |                           |
| $P_D$           | Total Device Dissipation                | 350                 | 225                     | mW                        |
|                 | Derate Above $25^\circ\text{C}$         | 2.8                 | 1.8                     | mW/ $^\circ\text{C}$      |
| $R_{\theta JC}$ | Thermal Resistance, Junction-to-Case    | 125                 |                         | $^\circ\text{C}/\text{W}$ |
| $R_{\theta JA}$ | Thermal Resistance, Junction-to-Ambient | 357                 | 556                     | $^\circ\text{C}/\text{W}$ |

**Note:**

3. Device mounted on FR-4 PCB 36mm x 18mm x 1.5mm; mounting pad for the collector lead minimum  $6\text{cm}^2$ .

### Electrical Characteristics

Values are at  $T_A = 25^\circ\text{C}$  unless otherwise noted.

| Symbol                              | Parameter                                      | Conditions   | Min. | Max.  | Unit             |
|-------------------------------------|--|--|------|-------|------------------|
| <b>Off Characteristics</b>          |  |  |      |       |                  |
| $V_{(BR)GSS}$                       | Gate-Source Breakdown Voltage                  | $I_G = 1.0 \mu\text{A}, V_{DS} = 0$                      | -25  |       | V                |
| $I_{GSS}$                           | Gate Reverse Current                           | $V_{GS} = 15 \text{ V}, V_{DS} = 0$                      |      | -100  | pA               |
| $V_{GS(off)}$                       | Gate-Source Cut-Off Voltage                    | $V_{DS} = 15 \text{ V}, I_D = 1.0 \text{ nA}$            | -2.5 | -4.5  | V                |
| <b>On Characteristics</b>           |  |  |      |       |                  |
| $I_{DSS}$                           | Zero-Gate Voltage Drain Current <sup>(4)</sup> | $V_{DS} = 15 \text{ V}, V_{GS} = 0$                      | 7.0  | 20    | mA               |
| <b>Small Signal Characteristics</b> |  |  |      |       |                  |
| $g_{fs}$                            | Common Source Forward Transconductance         | $V_{DS} = 15 \text{ V}, V_{GS} = 0, f = 1.0 \text{ kHz}$ | 7000 | 12000 | $\mu\text{mhos}$ |
| $g_{oss}$                           | Common Source Output Conductance               | $V_{DS} = 15 \text{ V}, V_{GS} = 0, f = 1.0 \text{ kHz}$ |      | 200   | $\mu\text{mhos}$ |

**Note:**

4. Pulse test: pulse width  $\leq 300 \mu\text{s}$

Typical Performance Characteristics

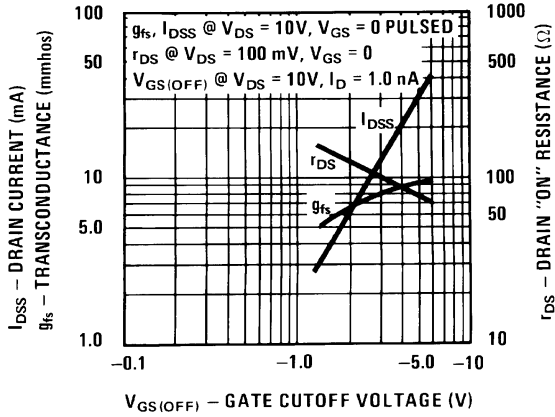

Figure 3. Parameter Interactions

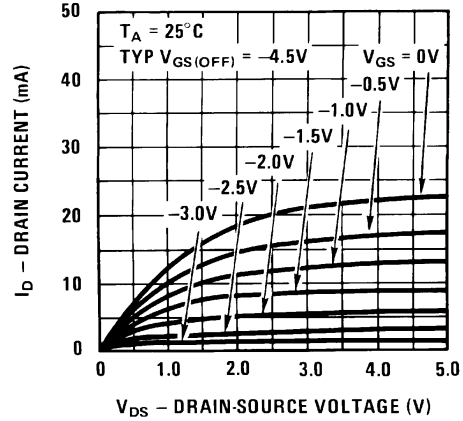

Figure 4. Common Drain-Source

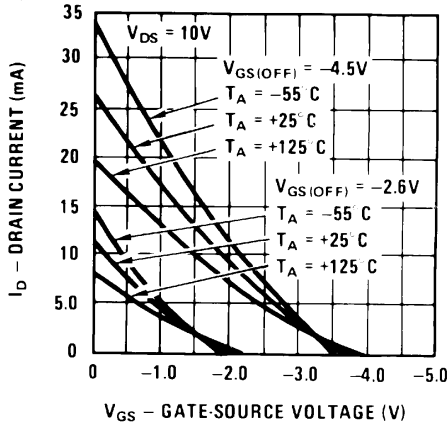

Figure 5. Transfer Characteristics

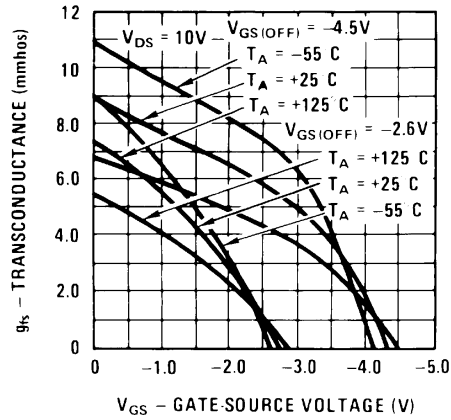

Figure 6. Transfer Characteristics

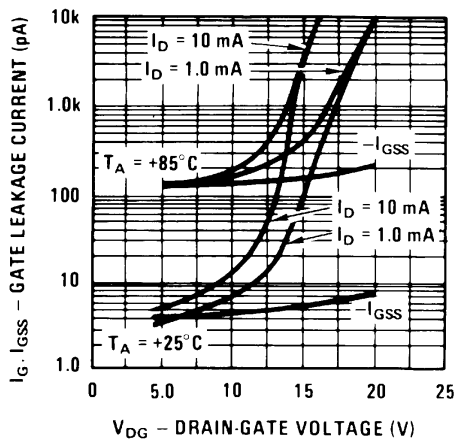

Figure 7. Leakage Current vs. Voltage

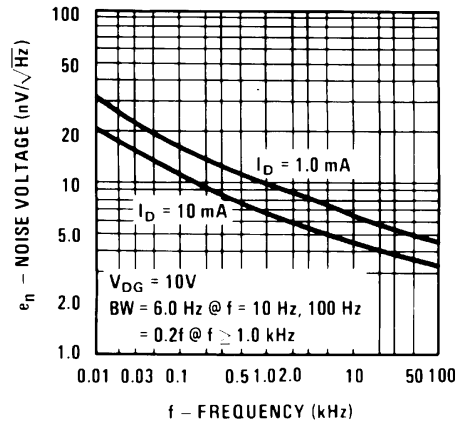

Figure 8. Noise Voltage vs. Frequency

Typical Performance Characteristics (Continued)

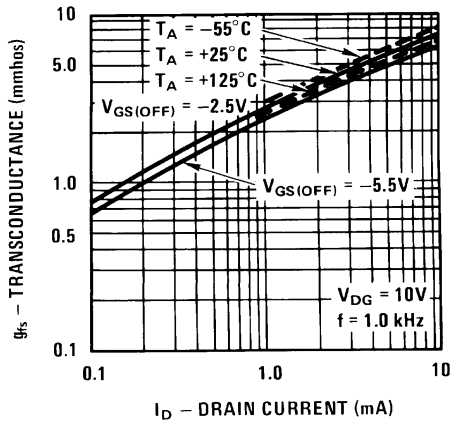

Figure 9. Transconductance vs. Drain Current

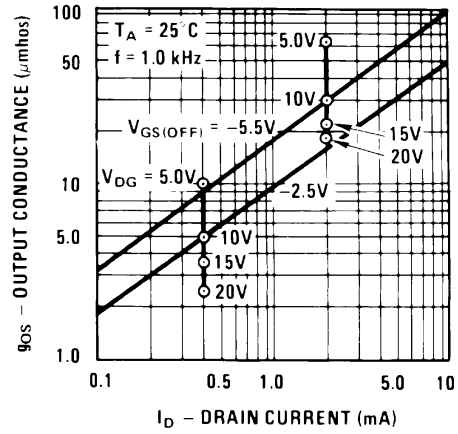

Figure 10. Output Conductance vs. Drain Current

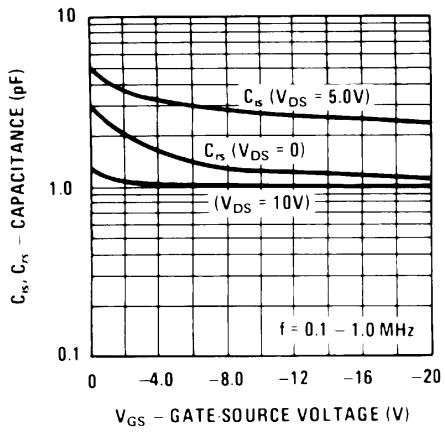

Figure 11. Capacitance vs. Voltage

Common Source Characteristics

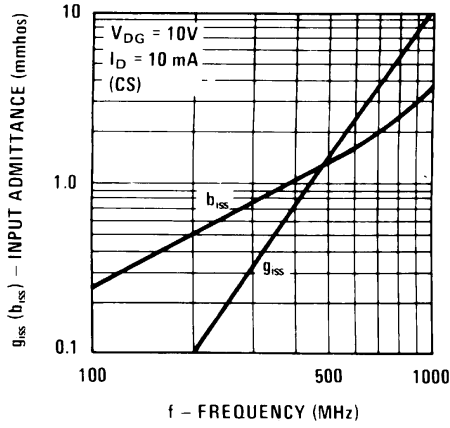

Figure 12. Input Admittance

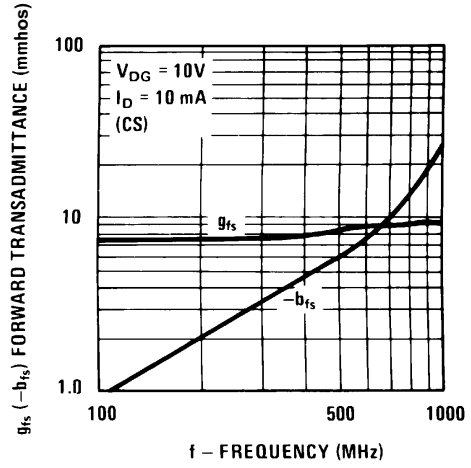

Figure 13. Forward Transadmittance

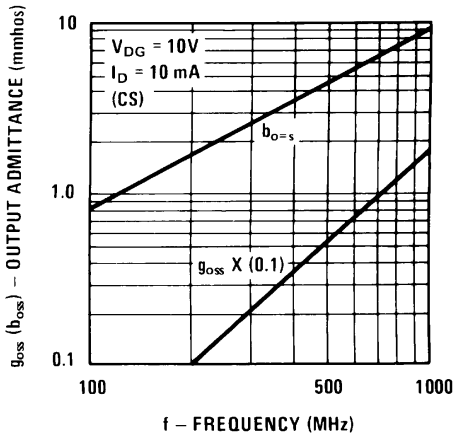

Figure 14. Output Admittance

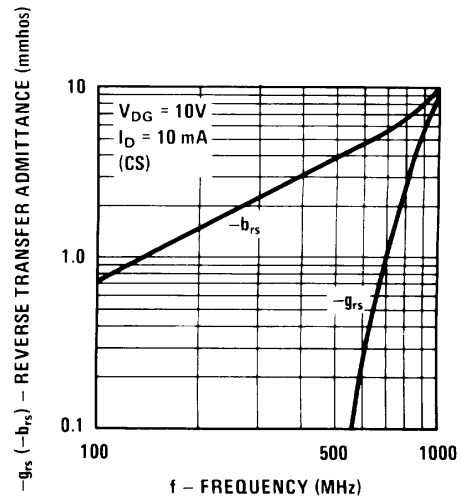

Figure 15. Reverse Transadmittance

Common Gate Characteristics

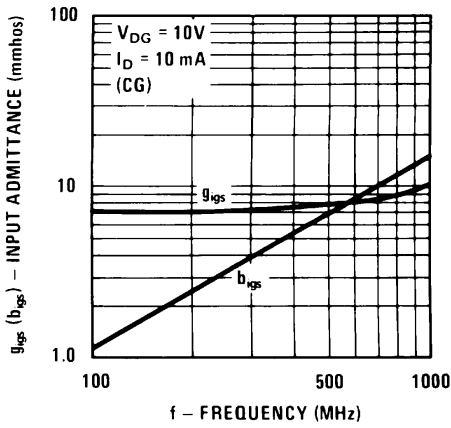

Figure 16. Input Admittance

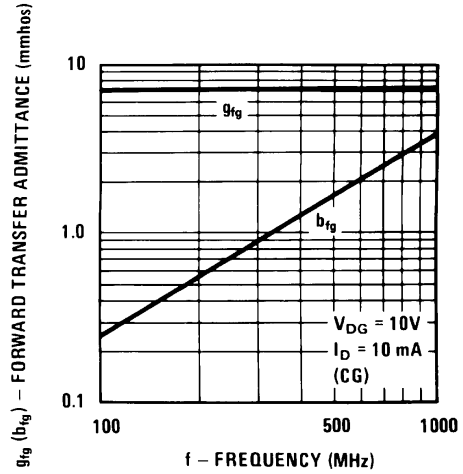

Figure 17. Forward Transadmittance

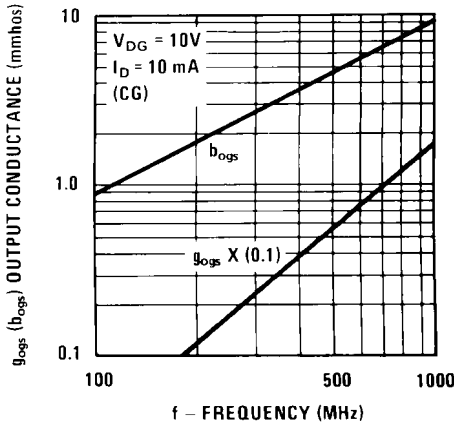

Figure 18. Output Admittance

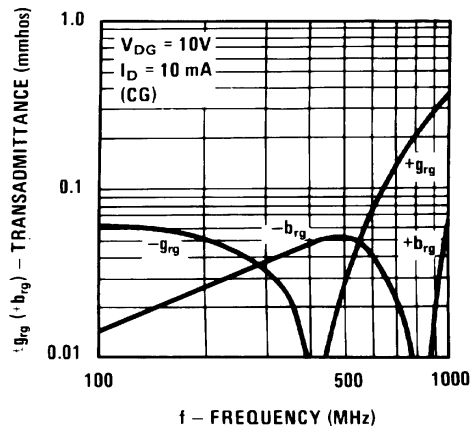
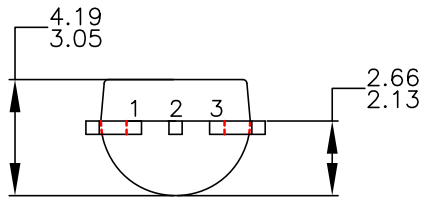
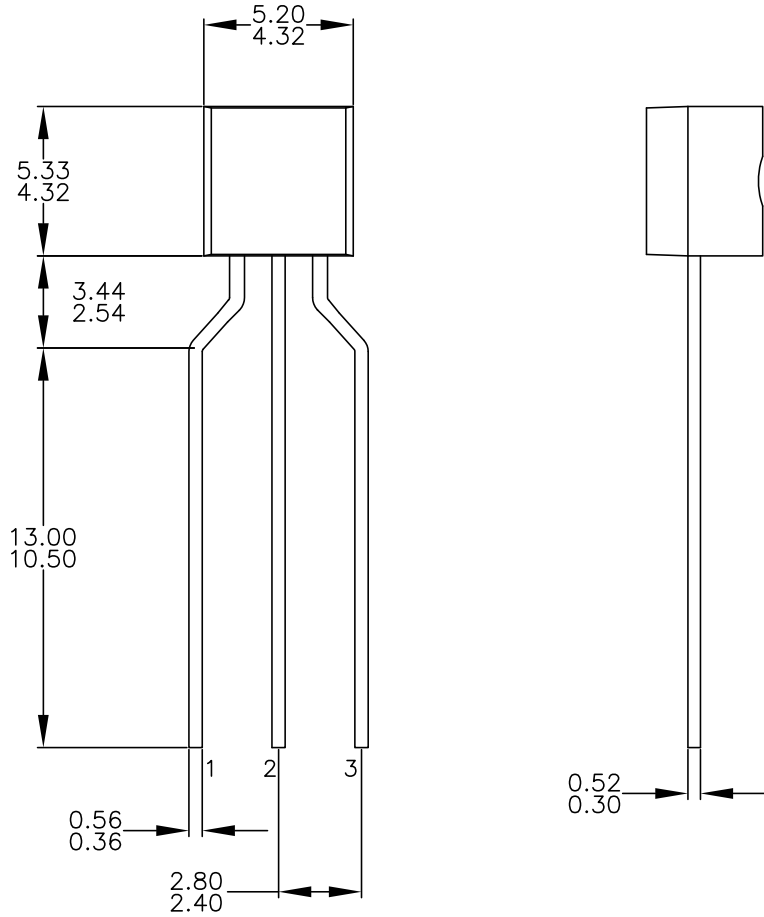

Figure 19. Reverse Transadmittance

Physical Dimensions



NOTES: UNLESS OTHERWISE SPECIFIED

- A. DRAWING CONFORMS TO JEDEC MS-013, VARIATION AC.
- B. ALL DIMENSIONS ARE IN MILLIMETERS.
- C. DRAWING CONFORMS TO ASME Y14.5M-2009.
- D. DRAWING FILENAME: MKT-ZA03FREV3.
- E. FAIRCHILD SEMICONDUCTOR.

Figure 20. 3-Lead, TO-92, Molded, 0.2 In Line Spacing Lead Form



Physical Dimensions (Continued)

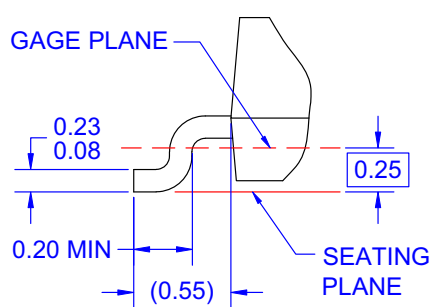
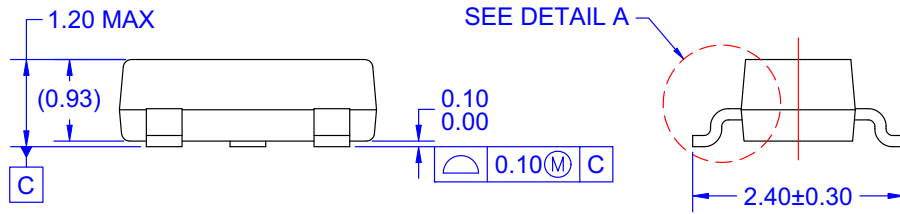
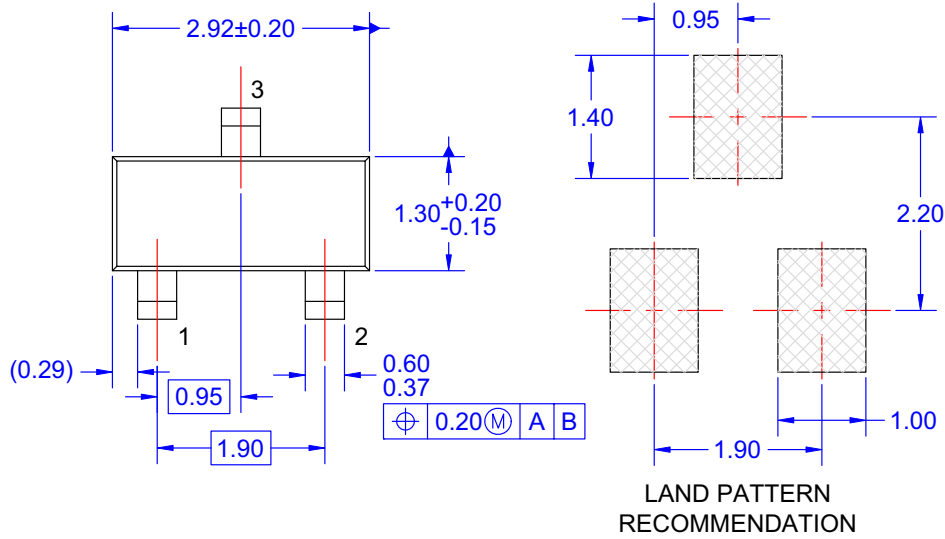

NOTES: UNLESS OTHERWISE SPECIFIED

- A) REFERENCE JEDEC REGISTRATION TO-236, VARIATION AB, ISSUE H.
- B) ALL DIMENSIONS ARE IN MILLIMETERS.
- C) DIMENSIONS ARE INCLUSIVE OF BURRS, MOLD FLASH AND TIE BAR EXTRUSIONS.
- D) DIMENSIONING AND TOLERANCING PER ASME Y14.5M - 1994.
- E) DRAWING FILE NAME: MA03DREV10

**DETAIL A**  
SCALE: 2X

Figure 21. 3-LEAD, SOT23, JEDEC TO-236, LOW PROFILE

ON Semiconductor and  are trademarks of Semiconductor Components Industries, LLC dba ON Semiconductor or its subsidiaries in the United States and/or other countries. ON Semiconductor owns the rights to a number of patents, trademarks, copyrights, trade secrets, and other intellectual property. A listing of ON Semiconductor's product/patent coverage may be accessed at [www.onsemi.com/site/pdf/Patent-Marking.pdf](http://www.onsemi.com/site/pdf/Patent-Marking.pdf). ON Semiconductor reserves the right to make changes without further notice to any products herein. ON Semiconductor makes no warranty, representation or guarantee regarding the suitability of its products for any particular purpose, nor does ON Semiconductor assume any liability arising out of the application or use of any product or circuit, and specifically disclaims any and all liability, including without limitation special, consequential or incidental damages. Buyer is responsible for its products and applications using ON Semiconductor products, including compliance with all laws, regulations and safety requirements or standards, regardless of any support or applications information provided by ON Semiconductor. "Typical" parameters which may be provided in ON Semiconductor data sheets and/or specifications can and do vary in different applications and actual performance may vary over time. All operating parameters, including "Typicals" must be validated for each customer application by customer's technical experts. ON Semiconductor does not convey any license under its patent rights nor the rights of others. ON Semiconductor products are not designed, intended, or authorized for use as a critical component in life support systems or any FDA Class 3 medical devices or medical devices with a same or similar classification in a foreign jurisdiction or any devices intended for implantation in the human body. Should Buyer purchase or use ON Semiconductor products for any such unintended or unauthorized application, Buyer shall indemnify and hold ON Semiconductor and its officers, employees, subsidiaries, affiliates, and distributors harmless against all claims, costs, damages, and expenses, and reasonable attorney fees arising out of, directly or indirectly, any claim of personal injury or death associated with such unintended or unauthorized use, even if such claim alleges that ON Semiconductor was negligent regarding the design or manufacture of the part. ON Semiconductor is an Equal Opportunity/Affirmative Action Employer. This literature is subject to all applicable copyright laws and is not for resale in any manner.

## PUBLICATION ORDERING INFORMATION

### LITERATURE FULFILLMENT:

Literature Distribution Center for ON Semiconductor  
19521 E. 32nd Pkwy, Aurora, Colorado 80011 USA  
**Phone:** 303-675-2175 or 800-344-3860 Toll Free USA/Canada  
**Fax:** 303-675-2176 or 800-344-3867 Toll Free USA/Canada  
**Email:** [orderlit@onsemi.com](mailto:orderlit@onsemi.com)

**N. American Technical Support:** 800-282-9855 Toll Free  
USA/Canada  
**Europe, Middle East and Africa Technical Support:**  
Phone: 421 33 790 2910  
**Japan Customer Focus Center**  
Phone: 81-3-5817-1050

**ON Semiconductor Website:** [www.onsemi.com](http://www.onsemi.com)  
**Order Literature:** <http://www.onsemi.com/orderlit>  
For additional information, please contact your local  
Sales Representative