

## *Brushless DC Motor Driver*

**RoHS**  
COMPLIANT

### FEATURES

- 30 A Continuous Output Current per Phase, 80 A Peak
- Up to 400 kHz Switching Frequency
- Up to 650 V Supply Voltage
- Internal Bootstrap Operation
- Undervoltage Lockout
- Active Miller Clamping
- Magnetic (Transformer) Isolation



### APPLICATIONS

- Motor Control
- Variable Frequency Drives
- DC/AC converters
- Power Inverters
- Test Equipment
- MRI Main Coil Supply

### DESCRIPTION

The SA310 is a fully integrated three-phase driver designed primarily to drive Brushless DC (BLDC) and Permanent Magnet Synchronous (PMSM) motors or DC/AC converters. The module uses Silicon Carbide MOSFET technology to improve efficiency over other devices in its class. Three independent half-bridges provide up to 80A peak output current under direct microcontroller or DSC control. SA310 is built on a thermally conductive, but electrically isolated substrate to provide the most versatility and ease in heatsinking.

The amplifier protection features include Under-voltage lockout (UVLO) function and active Miller clamping to reduce switching noise and improve reliability. Also included in the module are Silicon Carbide Schottky Barrier free-wheeling diodes to protect the body diode of each MOSFET. No external output protection diodes are required. The SA310's integrated gate drivers provide transformer isolation between the inputs and high-voltage outputs.

Figure 1: Equivalent Schematic

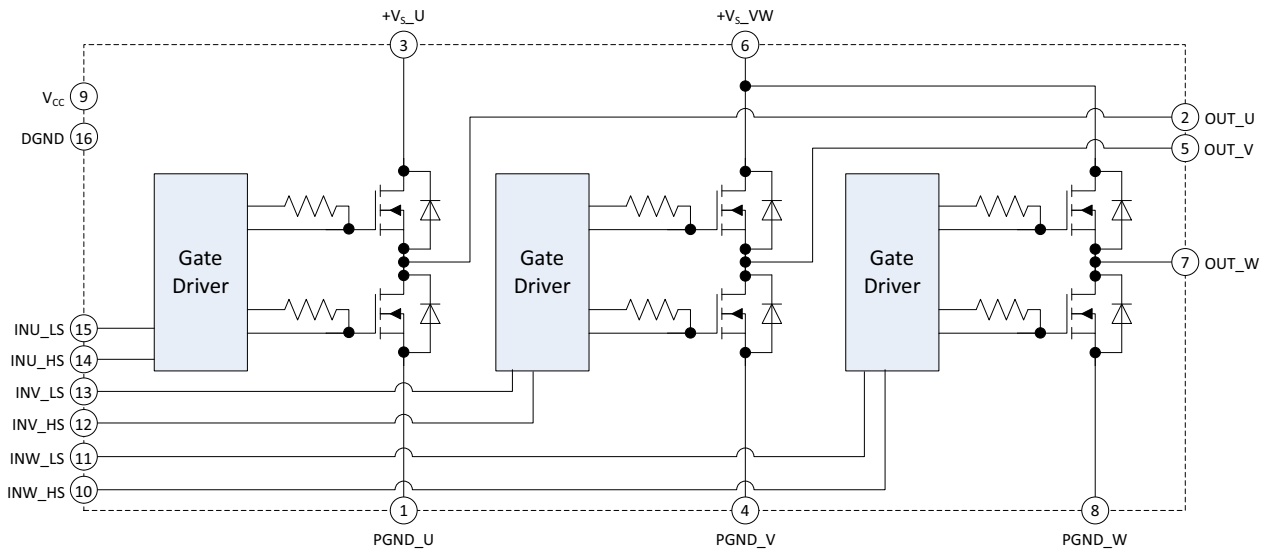
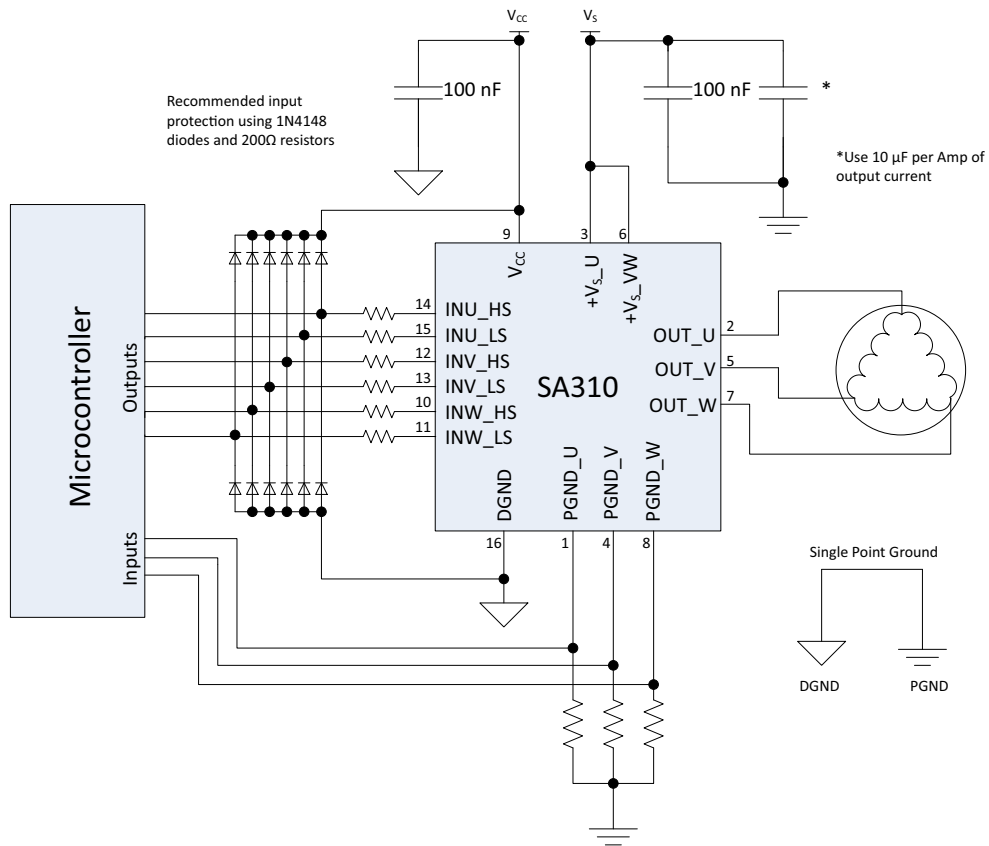
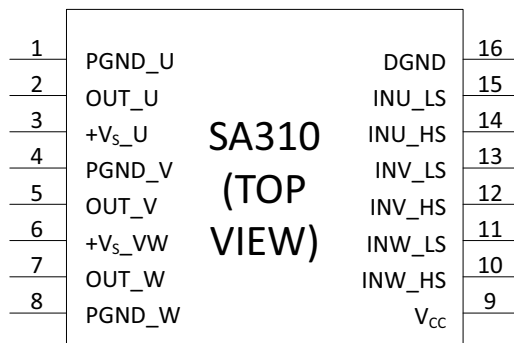

Figure 2: Typical Connection



**PINOUT AND DESCRIPTION TABLE**

**Figure 3: Pinout Diagram**



Pin Number	Name	Description
1	PGND_U	Return path for channel U. If desired, connect a current sense resistor between this pin and Power Ground. Otherwise, connect directly to Power Ground.
2	OUT_U	Output of channel U
3	+Vs_U	High-voltage supply for channel U.
4	PGND_V	Return path for channel V. If desired, connect a current sense resistor between this pin and Power Ground. Otherwise, connect directly to Power Ground.
5	OUT_V	Output of channel V
6	+Vs_VW	High-voltage supply for channel V and channel W.
7	OUT_W	Output of channel W
8	PGND_W	Return path for channel W. If desired, connect a current sense resistor between this pin and Power Ground. Otherwise, connect directly to Power Ground.
9	V <sub>CC</sub>	Voltage supply for logic circuit. The ground terminal of the supply must be connected to DGND.
10	INW_HS	Input signal to command channel W High-Side FET. Drive pin HIGH to source current through OUT_W.
11	INW_LS	Input signal to command channel W Low-Side FET. Drive pin HIGH to sink current through OUT_W.
12	INV_HS	Input signal to command channel V High-Side FET. Drive pin HIGH to source current through OUT_V.
13	INV_LS	Input signal to command channel V Low-Side FET. Drive pin HIGH to sink current through OUT_V.
14	INU_HS	Input signal to command channel U High-Side FET. Drive pin HIGH to source current through OUT_U.
15	INU_LS	Input signal to command channel U Low-Side FET. Drive pin HIGH to sink current through OUT_U.
16	DGND	Return path for digital circuit. Connect to Power Ground in one place to avoid creating ground loops.

## SPECIFICATIONS

Unless otherwise noted:  $T_C = 25\text{ }^\circ\text{C}$ . Power supply voltages are typical ratings.

### ABSOLUTE MAXIMUM RATINGS

Parameter	Symbol	Min	Max	Units
Total Supply Voltage	$+V_S$ to PGND		650	V
Logic Supply Voltage	$V_{CC}$		20	V
Output Current, source, sink, peak, within SOA	$I_{OUT}$		80	A
Output Current, continuous, within SOA	$I_{OUT}$		30	A
Power Dissipation, internal, continuous, total	$P_D$		111	W
Switching frequency	$f_{SW}$	0	400	kHz
Input Voltage, Logic Level	$V_{IN}$	-0.3	$V_{CC}+0.3$	V
Temperature, pin solder, 10s			350	$^\circ\text{C}$
Temperature, junction <sup>1</sup>	$T_J$		175	$^\circ\text{C}$
Temperature, storage		-55	150	$^\circ\text{C}$
Operating Temperature Range, case	$T_C$	-40	125	$^\circ\text{C}$

1. Long term operation at the maximum junction temperature will result in reduced product life. Derate internal power dissipation to achieve high MTTF.

**INPUT LOGIC**

Parameter	Test Conditions	Min	Typ	Max	Units
Input Low		0		0.8	V
Input High		2.0		V <sub>CC</sub>	V
Isolation			650		V

**OUTPUT**

Parameter	Test Conditions	Min	Typ	Max	Units
Current, Continuous	25°C Case Temperature	30			A
Rise Time			45		ns
Fall Time			30		ns
ON Resistance (Each FET) <sup>1</sup>	27A Load, T <sub>J</sub> = 25 °C		30		mΩ
ON Resistance (Each FET) <sup>1</sup>	27A Load, T <sub>J</sub> = 125 °C		39.6		mΩ
Switching Frequency	50% duty cycle, 1A output current			400	kHz
Minimum Load, Resistive		100			Ω

1. Does not include parasitic resistance of internal wirebonds.

**FREE-WHEELING DIODES**

Parameter	Test Conditions	Min	Typ	Max	Units
Current, Peak <sup>1</sup>				80	A
Current, Continuous		30			A
Reverse Recovery Time, t <sub>RR</sub>			19		ns
Forward Voltage	I <sub>AC</sub> = 20A		1.35		V

1. Guaranteed by Design

**POWER SUPPLY**

Parameter	Test Conditions	Min	Typ	Max	Units
Supply Voltage, +V <sub>S</sub>			300	600	V
Supply Voltage, V <sub>CC</sub>		14	18	20	V
Supply Current, V <sub>CC</sub>	All channels idle	5	8	14	mA

**THERMAL**

Parameter	Test Conditions	Min	Typ	Max	Units
Resistance, Junction to Case, MOSFETs, AC	3-phase loading <sup>1</sup> , $f_{SW} > 60$ Hz			0.63	°C/W
Resistance, Junction to Case, MOSFETs, DC	$f_{SW} < 60$ Hz			1.35	°C/W
Resistance, Junction to Case, Free-wheeling Diodes, DC	3-phase loading <sup>2</sup> , $f_{SW} < 60$ Hz			0.48	°C/W
Resistance, Junction to Air, MOS-FETs	3-phase loading <sup>1</sup>		13		°C/W
Resistance, Junction to Air, Free-wheeling Diodes	3-phase loading <sup>2</sup>		3		°C/W
Temperature Range, Case <sup>3</sup>		-40		125	°C

1. All three phases active in a typical 6-step sequence. Power is shared evenly in all 6 MOSFET devices.
2. Power is shared evenly in all 6 diode devices.
3. Case Temperature must be derated with Switching Frequency. See Figure 12.

Figure 4: Power Derating

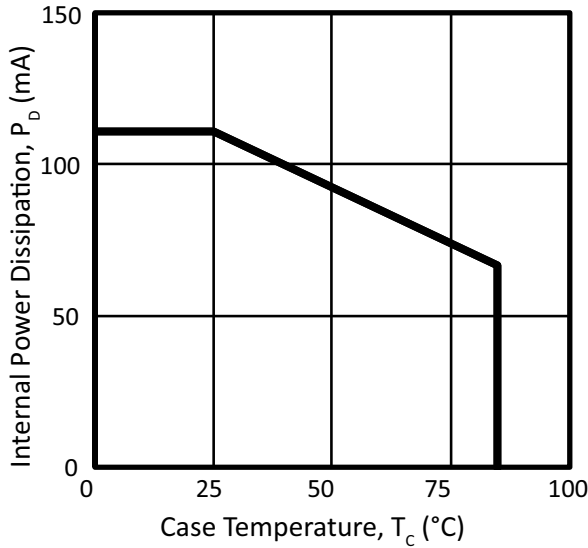

Figure 5:  $I_{CC}$  vs. Switching Frequency

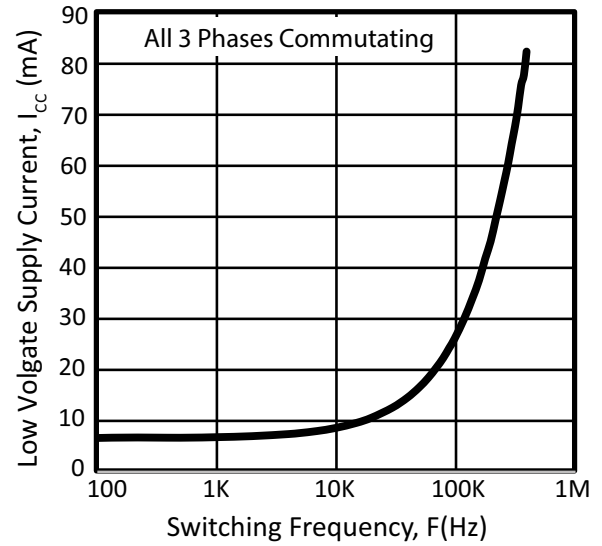

Figure 6: ON Resistance vs.  $I_{OUT}$

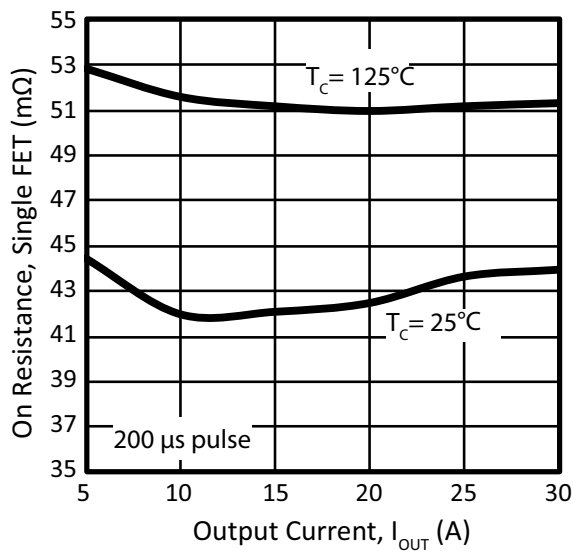

Figure 7: Diode Forward Voltages vs.  $I_{SD}$

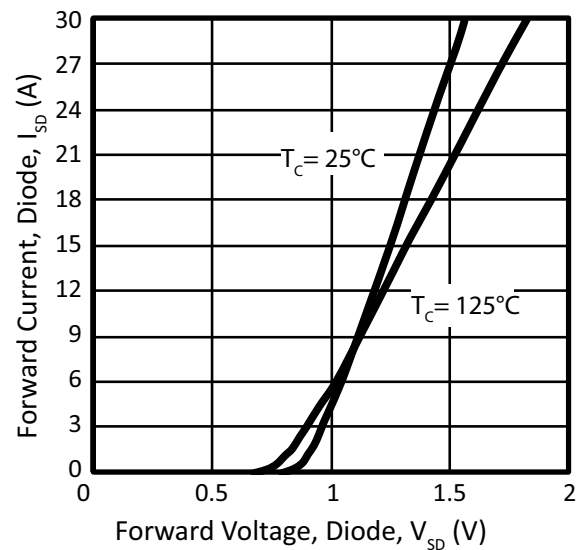

Figure 8: Diode Leakage Current vs.  $V_s$

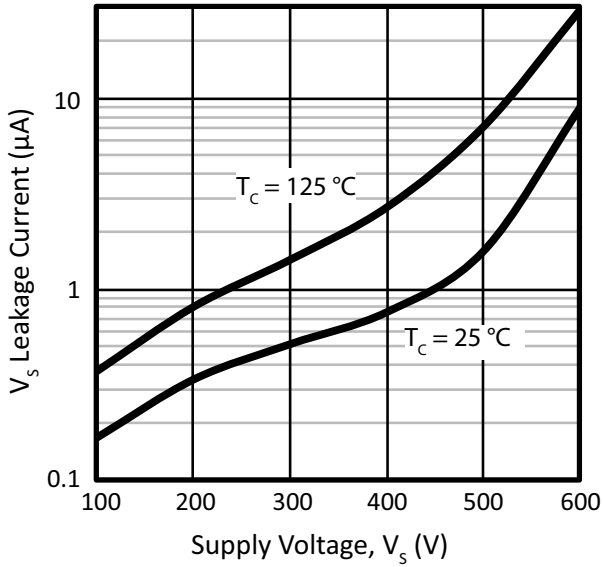

Figure 9: Safe Operating Area, No Heat-sink, Free Air

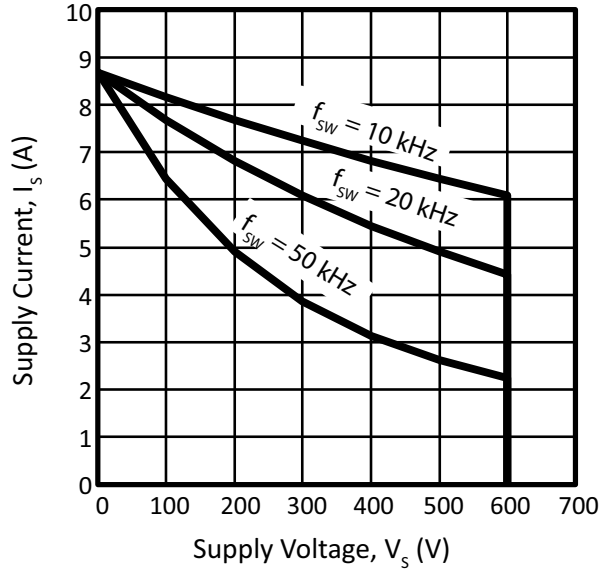

Figure 10: Safe Operating Area, HS39 Heat-sink, Free Air

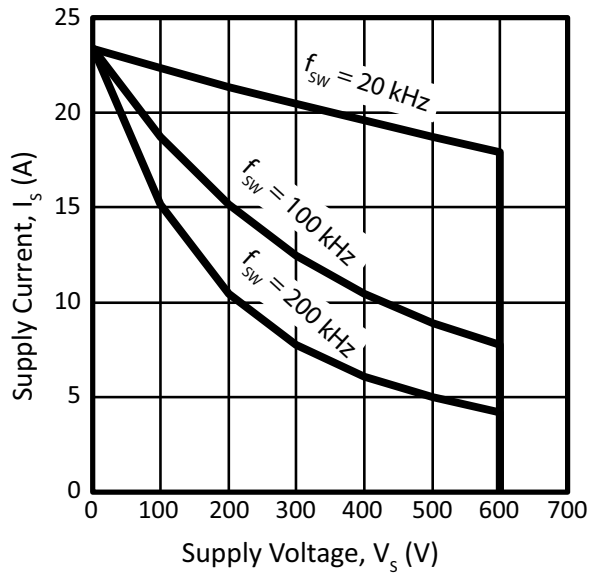

Figure 11: Safe Operating Area, HS39 Heat-sink, 600 LFM Forced Air

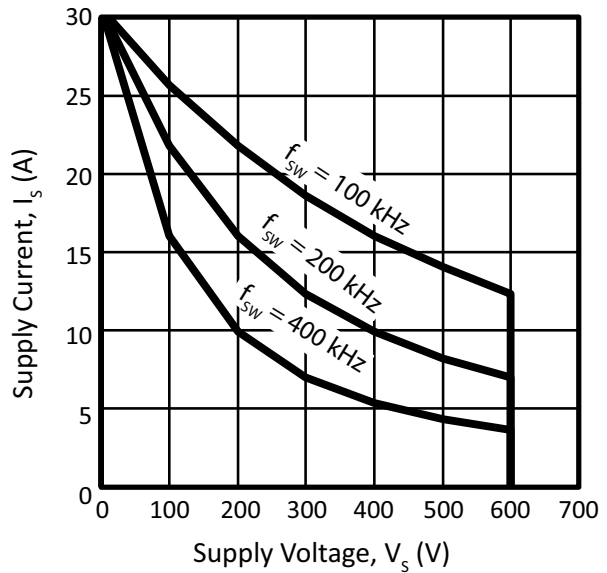
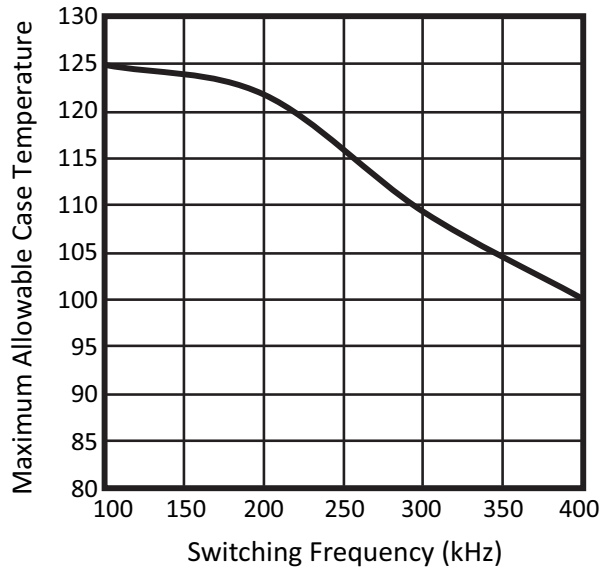



Figure 12: Case Temperature Derating



## GENERAL

Please read Application Note 1 “General Operating Considerations” which covers stability, supplies, heat sinking, mounting, current limit, SOA interpretation, and specification interpretation. Visit [www.apexanalog.com](http://www.apexanalog.com) for Apex Microtechnology's complete Application Notes library, Technical Seminar Workbook, and Evaluation Kits.

## CALCULATING POWER DISSIPATION

Power dissipation internal to the SA310 consists mostly of 2 elements, which may be calculated as follows:

### 1. Conduction Losses

$$P_{CONDUCTION} = (I_S)^2 \times R_{DS(ON)} \times X [W]$$

$$X = 1.5 \text{ for Wye or Delta loads}$$

$$X = 2 \text{ for Single Ended loads having sinking AND sourcing current}$$

$$X = 1 \text{ for Single Ended loads having sinking OR sourcing current}$$

### 2. Switching Losses

$$P_{SWITCHING} = \frac{3}{2} \times V_S \times I_S \times f_{SWITCHING} \times (t_{RISE} + t_{FALL}) [W]$$

Given in above specification tables and performance graphs:

$$R_{DS(ON)} = \text{ON Resistance (each FET)} [\Omega]$$

$$t_{RISE} = \text{Rise Time [s]}$$

$$t_{FALL} = \text{Fall Time [s]}$$

Application Specific:

$$I_S = \text{Average Supply Current from } V_S \text{ Power Supply [A]}$$

$$V_S = \text{Supply Voltage [V]}$$

$$f_{SWITCHING} = \text{Switching Frequency of Input Signal [Hz]}$$

After calculating these powers, it is often necessary to calculate if a heatsink is required, or how big of a heatsink is needed.

First, determine the case and junction temperatures assuming no heatsink:

$$T_{JUNCTION,FET} = T_{AMBIENT} + (P_{CONDUCTION} + P_{SWITCHING}) \times \theta_{JA,FET} [^{\circ}C]$$

$$T_{CASE} = T_{JUNCTION,FET} - (P_{CONDUCTION} + P_{SWITCHING}) \times \theta_{JC,FET} [^{\circ}C]$$

Where:

$$\theta_{JA,FET} = \text{Thermal Resistance, Junction to Air, MOSFETs } [^{\circ}C/W]$$

$$\theta_{JC,FET} = \text{Thermal Resistance, Junction to Case, MOSFETs } [^{\circ}C/W]$$

If these temperatures are within the absolute maximum ratings and within the design requirements, no heat-sink is required. Otherwise, use the following formulas to determine the maximum heatsink thermal rating:

$$\theta_{SA} = \frac{T_{CASE,DESIRED} - T_{AMBIENT}}{P_{CONDUCTION} + P_{SWITCHING}} - \theta_{CS} \left[ \frac{^{\circ}C}{W} \right]$$

$$\theta_{SA} = \frac{T_{JUNCTION,FET,DESIRED} - (P_{CONDUCTION} + P_{SWITCHING}) \times \theta_{JC,FET} - T_{AMBIENT}}{P_{CONDUCTION} + P_{SWITCHING}} - \theta_{CS} \left[ \frac{^{\circ}C}{W} \right]$$

Where:

$\theta_{SA}$  = Heatsink Thermal Rating [ $^{\circ}C/W$ ]

$\theta_{CS}$  = Thermal Interface Rating [ $^{\circ}C/W$ ]

Select the largest heatsink (lowest thermal rating) of the two equations.

## UNDER-VOLTAGE LOCKOUT FUNCTION

The SA310 has a built-in under-voltage lockout function. When  $V_{CC}$  drops below approximately 9V, the outputs will be high impedance. When  $V_{CC}$  rises above approximately 10V, the outputs will return to normal operating mode. In addition, to prevent malfunctions due to noise, a mask time of approximately 2.5 $\mu$ s is set on  $V_{CC}$ .

## BYPASSING

Adequate bypassing of the power supplies is required for proper operation. Failure to do so can cause erratic and low efficiency operation as well as excessive ringing at the outputs. The  $V_S$  supply should be bypassed with at least a 1 $\mu$ F ceramic capacitor in parallel with another low ESR capacitor of a least 10 $\mu$ F per amp of output current. Capacitor types rated for switching applications are the only types that should be considered. The 1 $\mu$ F ceramic capacitor must be physically connected directly to the + $V_S$  and PGND nodes. Even one inch of lead length will cause excessive ringing at the outputs. This is due to the very fast switching times and the inductance of the lead connection. The bypassing requirements of the  $V_{CC}$  supply are less stringent, but still necessary. A 0.1 $\mu$ F to 0.47 $\mu$ F ceramic capacitor connected directly from the  $V_{CC}$  pin to DGND close to the SA310 will suffice.

## POWER SUPPLY PROTECTION

Unidirectional transient Voltage suppressors are recommended as protection on the supply pins as shown in figure 13. TVS diodes clamp transients to voltages within the power supply rating and clamp power supply reversals to ground. Whether the TVS diodes are used or not, the system power supply should be evaluated for transient performance including power-on overshoot and power-off polarity reversal as well as line regulation. Conditions which can cause open circuits or polarity reversals on either power supply rail should be avoided or protected against. Unidirectional TVS diodes prevent this, and it is desirable that they be both electrically and physically as close to the amplifier as possible.

Figure 13: TVS Diodes

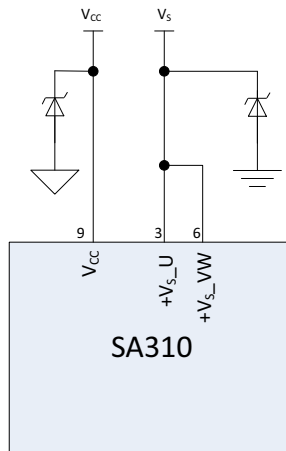

## INPUT PROTECTION

It is recommended to connect two small-signal diodes at each of the input signals to provide external protection for the SA310, as shown in the typical connection diagram. A 100pF capacitor can be connected from each input to ground to provide ESD protection from coaxial cables and other ESD sources. A series resistor (approximately 200  $\Omega$ ) may be added in series with the input pins to limit excessive current going into the pins. Without these protection features, SA310 is susceptible to permanent input stage failure.

Each INX\_LS and INX\_HS has an internal pull-down resistance to DGND of 50 k $\Omega$  typical.

## DEAD TIME

Dead time is entirely user-selectable and must be considered when generating an input signal. Generally, dead time is chosen as a multiple of clock-cycles from the system controller; this makes the coordination of \_HS and \_LS inputs easy. The minimum recommended dead time is 60ns.

## OUTPUT LOGIC

SA310 follows the following truth table for each phase:

INX_LS	INX_HS	OUT_X
L	L	High-Impedance
L	H	H
H	L	L
H	H	High-Impedance

## **POWER SUPPLY SEQUENCING**

During power-on of the SA310, turn on power supplies in the following order:

1. VCC
2. +VS

During power-off of the SA310, turn off power supplies in the reverse order.

## PACKAGE OPTIONS

Part Number	Apex Package Style	Description
SA310	KR	16-pin Power DIP

### PACKAGE STYLE KR

**NOTES:**

1. Dimensions are in inches & [mm].
2. Triangle on lid and notch in header denote pin 1.
3. Header material: Nickel-plated CRS
4. Lid material: Solid nickel
5. Pin material: Solderable nickel-plated Alloy 52
6. Welded hermetic package seal
7. Isolation: 1000 VDC any pin to case

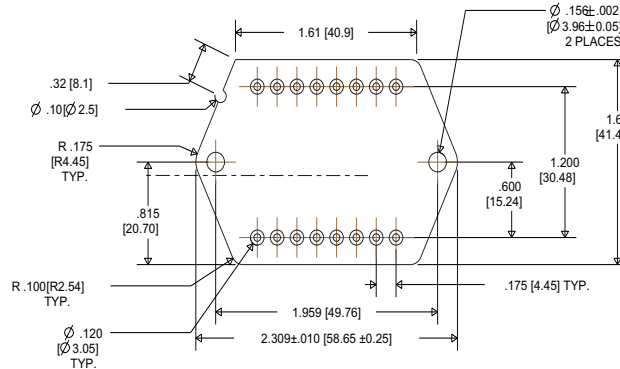
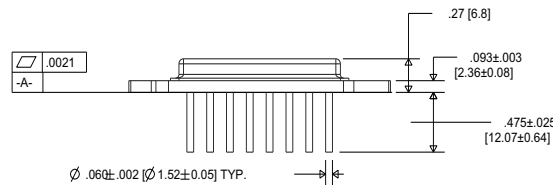
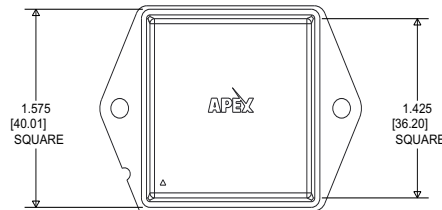
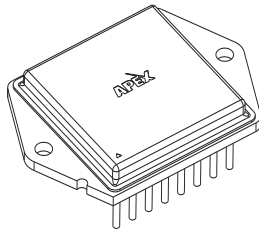

## NEED TECHNICAL HELP? CONTACT APEX SUPPORT!

For all Apex Microtechnology product questions and inquiries, call toll free 800-546-2739 in North America. For inquiries via email, please contact [apex.support@apexanalog.com](mailto:apex.support@apexanalog.com). International customers can also request support by contacting their local Apex Microtechnology Sales Representative. To find the one nearest to you, go to [www.apexanalog.com](http://www.apexanalog.com)

### IMPORTANT NOTICE

Apex Microtechnology, Inc. has made every effort to insure the accuracy of the content contained in this document. However, the information is subject to change without notice and is provided "AS IS" without warranty of any kind (expressed or implied). Apex Microtechnology reserves the right to make changes without further notice to any specifications or products mentioned herein to improve reliability. This document is the property of Apex Microtechnology and by furnishing this information, Apex Microtechnology grants no license, expressed or implied under any patents, mask work rights, copyrights, trademarks, trade secrets or other intellectual property rights. Apex Microtechnology owns the copyrights associated with the information contained herein and gives consent for copies to be made of the information only for use within your organization with respect to Apex Microtechnology integrated circuits or other products of Apex Microtechnology. This consent does not extend to other copying such as copying for general distribution, advertising or promotional purposes, or for creating any work for resale.

APEX MICROTECHNOLOGY PRODUCTS ARE NOT DESIGNED, AUTHORIZED OR WARRANTED TO BE SUITABLE FOR USE IN PRODUCTS USED FOR LIFE SUPPORT, AUTOMOTIVE SAFETY, SECURITY DEVICES, OR OTHER CRITICAL APPLICATIONS. PRODUCTS IN SUCH APPLICATIONS ARE UNDERSTOOD TO BE FULLY AT THE CUSTOMER OR THE CUSTOMER'S RISK.

Apex Microtechnology, Apex and Apex Precision Power are trademarks of Apex Microtechnology, Inc. All other corporate names noted herein may be trademarks of their respective holders.

# Mouser Electronics

Authorized Distributor

Click to View Pricing, Inventory, Delivery & Lifecycle Information:

[Apex Microtechnology:](#)

[SA310KR](#)