

Features:

- Thin film technology for precision and stability
- Excellent power to size ratio
- Outstanding pulse handling
- Excellent overall stability
- Sn termination on Ni barrier layer
- Tight tolerance down to $\pm 0.1\%$
- Extremely low TCR down to $\pm 5 \text{ ppm}/^\circ\text{C}$
- High power rating up to 1W
- SMD enabled structure
- AEC-Q200 compliance
- RoHS compliant, lead free and halogen free



Electrical Specifications									
Type / Code	Package Size	Power Rating (Watts) @ 70 °C	Maximum Working Voltage ⁽¹⁾	Maximum Overload Voltage ⁽²⁾	TCR (ppm/°C)	Ohmic Range (Ω) and Tolerance			
						0.1%	0.5%	1%	5%
MLFA13 ⁽³⁾	0102	0.3 Jumper: 2 A	200	400	± 50	-	1 - 1M		
					± 100	-	1 - 1M		
					-	0 Ω (< 15mΩ)			
MLFA25	0204	0.4 Jumper: 3 A	200	400	± 5	10 - 332K	-		
					± 15	10 - 300K			
					± 25	10 - 1M	10 - 3.4M	1 - 3.4M	
					± 50	10 - 1M	1 - 3.4M	0.2 - 3.4M	
					± 100	-		0.1 - 1M	
					-	0 Ω (< 15mΩ)			
MLFA1	0207	1 Jumper: 5 A	350	700	± 5	10 - 332K	-		
					± 15	10 - 300K			
					± 25	10 - 1M	10 - 3.4M	1 - 3.4M	
					± 50	10 - 1M	1 - 3.4M	0.2 - 3.4M	
					± 100	-		0.1 - 1M	
					-	0 Ω (15 mΩ)			

⁽¹⁾ Working Voltage = $\sqrt{(P \cdot R)}$ or Max. Operating Voltage listed above, whichever is lower.

⁽²⁾ Overload Voltage = $2.5 \cdot \sqrt{(P \cdot R)}$ or Max. Overload Voltage listed above, whichever is lower.

⁽³⁾ Lower TCR with lower Power Ratings may be available - contact Stackpole

RCWV (Rated Continuous Working Voltage) = $\sqrt{(P \cdot R)}$ or Max Operating Voltage, whichever is lower.

Mechanical Specifications

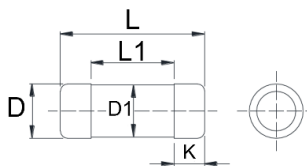

Type / Code	Weight (g) (1000 pc)	L Body Length	L1 (min.) Inner Body Length	D Body Diameter	D1 Middle Body Dia.	K Termination	Unit
MLFA13	7.7	0.087 ± 0.004	0.043	0.043 ± 0.004	0.043 +0/-0.006	0.018 ± 0.002	inches mm
		2.20 ± 0.10	1.10	1.10 ± 0.10	1.10 +0/-0.15	0.45 ± 0.05	
MLFA25	18.7	0.138 ± 0.008	0.067	0.055 ± 0.006	0.055 +0/-0.008	0.031 ± 0.004	inches mm
		3.50 ± 0.20	1.70	1.40 ± 0.15	1.40 +0/-0.2	0.80 ± 0.10	
MLFA1	80.9	0.232 ± 0.008	0.114	0.087 ± 0.008	0.087 +0/-0.008	0.051 ± 0.004	inches mm
		5.90 ± 0.20	2.90	2.20 ± 0.20	2.20 +0/-0.2	1.30 ± 0.10	

Power Derating Curve:

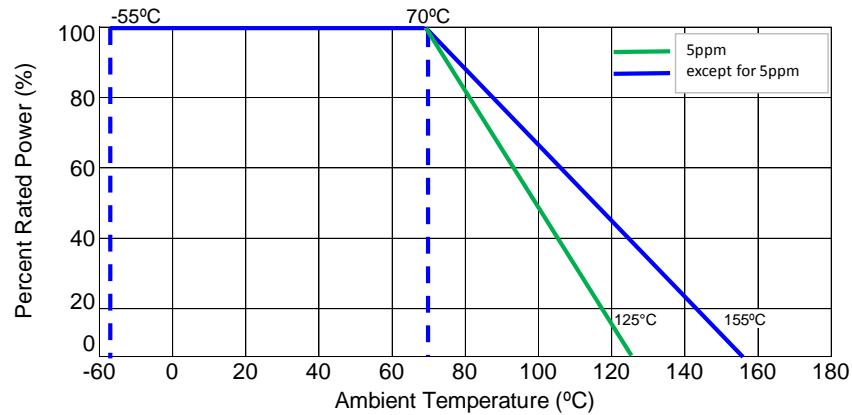

Performance Characteristics				
Test	Test Method	Test Method	Test Specification	
			5% and below	Jumper
Temperature Coefficient of Resistance (T.C.R.)	JIS-C-5201-1 4.8 IEC-60115-1 4.8	At 25 °C / - 55 °C and 25 °C / + 125 °C, 25 °C is the reference temperature. 5ppm: At 25 °C / -10 °C and 25 °C / +85 °C, 25 °C is the reference temperature	As specified	
Short Time Overload	JIS-C-5201-1 4.13 IEC-60115-1 4.13	RCWV*2.5 or max. overload voltage whichever is lower for 5 seconds	10 Ω - 270 KΩ: ± (0.1% + 0.01 Ω) < 10 Ω & > 270 KΩ: ± (0.15% + 0.01 Ω) MLFA13: ± (0.15% + 0.01 Ω) 5 ppm/°C: ± (0.05% + 0.01 Ω)	< 15mΩ
Insulation Resistance	JIS-C-5201-1 4.6 IEC-60115-1 4.6	Max. overload voltage for 1 minute	≥10G	
Operational Life	MIL-STD-202 Method 108	Condition D Steady State TA = 125 °C at derated power. Measurement at 24 ± 4 hours after test conclusion. 5 ppm/°C: 70 ± 2 °C, RCWV for 1000 hours with 1.5 hours "ON" and 0.5 hour "OFF"	10 Ω - 270 KΩ: ± (0.25% + 0.01 Ω) < 10 Ω & > 270 KΩ: ± (0.5% + 0.01 Ω) MLFA13: ± (0.5% + 0.01 Ω)	< 15mΩ
Biased Humidity	MIL-STD-202 Method 103	1000 hours 85 °C / 85% R.H. 10% of operating power	10 Ω - 270 KΩ: ± (0.5% + 0.01 Ω) < 10 Ω & > 270 KΩ: ± (1% + 0.01 Ω) MLFA13: ± (2% + 0.01 Ω)	< 15mΩ
High Temperature Exposure	MIL-STD-202 Method 108	at +125 °C / +155 °C for 1000 hours	10 Ω - 270 KΩ: ± (0.25% + 0.01 Ω) < 10 Ω & > 270 KΩ: ± (1% + 0.01 Ω) MLFA13: ± (1% + 0.01 Ω)	< 15mΩ
Board Flex	AEC-Q200-005	Bending once for 60 seconds with 2 mm	10 Ω - 270 KΩ: ± (0.1% + 0.01 Ω) < 10 Ω & > 270 KΩ: ± (0.5% + 0.01 Ω) MLFA13: ± (0.5% + 0.01 Ω)	< 15mΩ
Solderability	JIS-5201-1 4.17 IEC 60115-1 4.17 J-STD 002	245 ± 5 °C for 3 seconds	95% min. coverage	
Resistance to Soldering Heat	MIL-STD-202 Method 210	260 ± 5 °C for 10 seconds	10 Ω - 270 KΩ: ± (0.1% + 0.01 Ω) < 10 Ω & > 270 KΩ: ± 0.25% + 0.01 Ω) MLFA13: ± (0.25% + 0.01 Ω) 5 ppm/°C: ± (0.05% + 0.01 Ω)	< 15mΩ
Voltage Proof	JIS-C-5201-1 4.7 IEC 60115-1 4.7	1.42 times max. operating voltage for 1 minute	No breakdown or flashover	

Performance Characteristics (cont.)				
Test	Test Method	Test Method	Test Specification	
			5% and below	Jumper
Leaching	JIS-C-5201-1 4.18 IEC-60068-2-58 8.2.1	260 ± 5 °C for 30 seconds	Individual leaching area ≤ 5% Total leaching area ≤ 10%	
Temperature Cycling	JESD22 Method JA-104	-55 °C to + 125 °C, 1000 cycles	10 Ω - 270 KΩ: ± (0.25% + 0.01 Ω) < 10 Ω & > 270 KΩ: ± 0.5% + 0.01 Ω) MLFA13: ± (1% + 0.01 Ω)	< 15mΩ
Mechanical Shock	MIL-STD-202 Method 213	Wave Form: Tolerance for half sine shock pulse. 'Peak value is 100 g's. Normal duration (D) is 6.	± (0.25% + 0.01 Ω)	< 15mΩ
Vibration	MIL-STD-202 Method 204	5 g's for 20 minutes., 12 cycles each of 3 orientations 10-2000 Hz	± (0.5% + 0.01 Ω)	< 15mΩ
ESD	AEC-Q200-002	Human body, 2 KV	± (0.5% + 0.05 Ω)	< 15mΩ
Resistance to Solvents	MIL-STD-202 Method 215	Add aqueous wash chemical - OKEM clean or equivalent. Do not use banned solvents.	No visible damage on appearance and marking.	
Terminal Strength	AEC-Q200-006	Force of 1.8 Kg for 60 seconds	No breakage	
Flammability	UL-94	V - 0 or V - 1 are acceptable. Electrical test not required.	No ignition of the tissue paper or scorching of the pinewood board	

RCWV (rated continuous working voltage) = $\sqrt{P \cdot R}$ or max. operating voltage whichever is lower

Storage temperature: 15 ~ 28°C. Humidity < 80% R.H.

Operating temperature range is -55°C to +125°C for 5 ppm/°C

Operating temperature range is -55°C to +155°C for all others except 5 ppm/°C

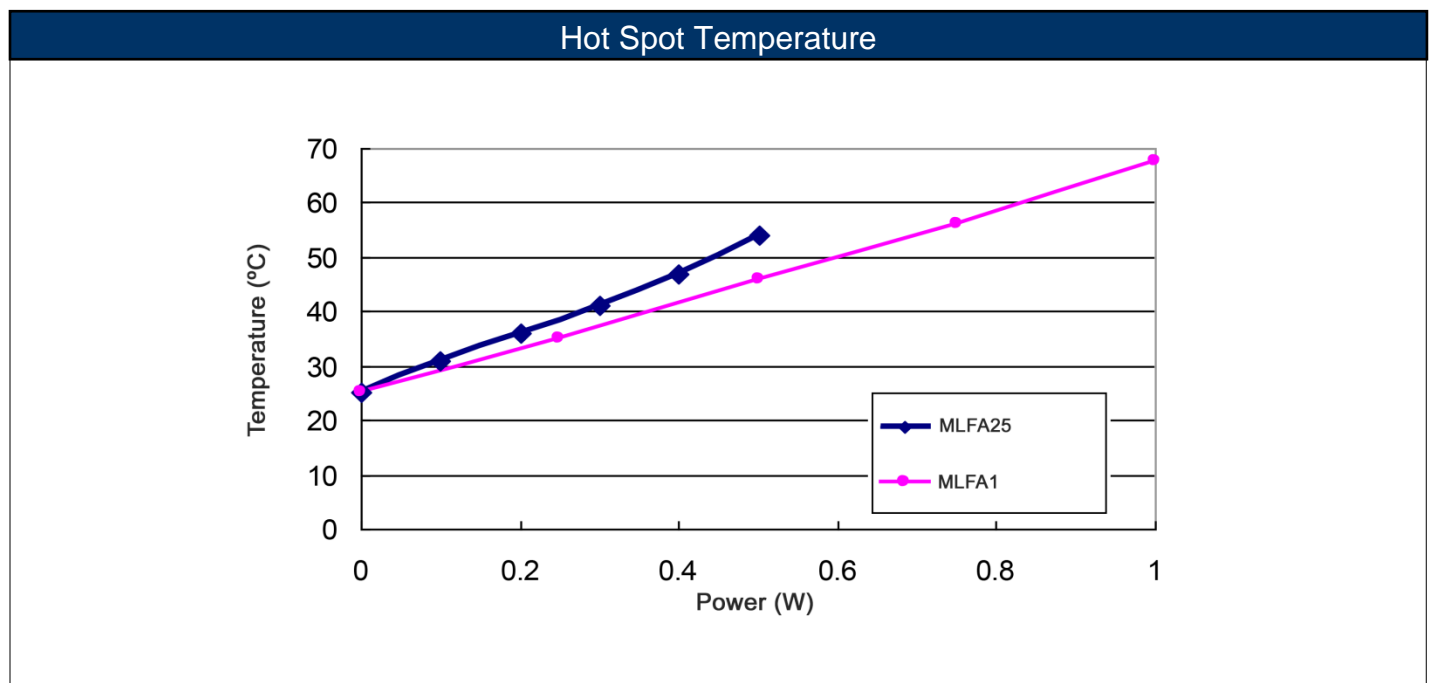

Reel Specifications

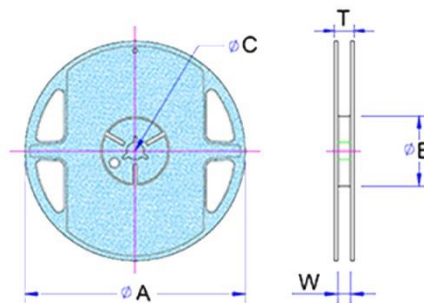

Type / Code	Reel Diameter	ϕA	ϕB	ϕC	W	T	Unit
MLFA13	0.276	7.028 ± 0.059	2.362 ± 0.039	0.512 ± 0.008	0.354 ± 0.020	0.492 ± 0.020	inches
	7.00	178.50 ± 1.50	60.00 ± 1.00	13.00 ± 0.20	9.00 ± 0.50	12.50 ± 0.50	mm
MLFA25	0.276	7.028 ± 0.059	2.362 ± 0.039	0.512 ± 0.008	0.354 ± 0.020	0.492 ± 0.020	inches
	7.00	178.50 ± 1.50	60.00 ± 1.00	13.00 ± 0.20	9.00 ± 0.50	12.50 ± 0.50	mm
MLFA1	0.276	7.028 ± 0.059	2.362 ± 0.039	0.512 ± 0.020	0.512 ± 0.020	0.610 ± 0.020	inches
	7.00	178.50 ± 1.50	60.00 ± 1.00	13.00 ± 0.50	13.00 ± 0.50	15.50 ± 0.50	mm

Packaging Specifications - Embossed Plastic Tape

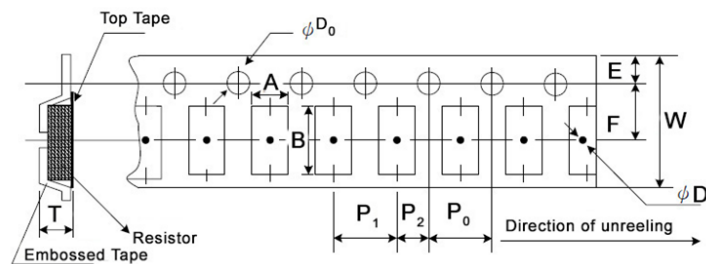

Type / Code	A	B	W	E	F	P0	Unit
MLFA13	0.051 ± 0.004	0.094 ± 0.004	0.315 ± 0.004	0.069 ± 0.004	0.138 ± 0.002	0.157 ± 0.004	inches
	1.30 ± 0.10	2.40 ± 0.10	8.00 ± 0.10	1.75 ± 0.10	3.50 ± 0.05	4.00 ± 0.10	mm
MLFA25	0.061 ± 0.004	0.144 ± 0.004	0.315 ± 0.004	0.069 ± 0.004	0.138 ± 0.002	0.157 ± 0.004	inches
	1.55 ± 0.10	3.65 ± 0.10	8.00 ± 0.10	1.75 ± 0.10	3.50 ± 0.05	4.00 ± 0.10	mm
MLFA1	0.094 ± 0.004	0.242 ± 0.004	0.472 ± 0.004	0.069 ± 0.004	0.217 ± 0.002	0.157 ± 0.004	inches
	2.40 ± 0.10	6.15 ± 0.10	12.00 ± 0.10	1.75 ± 0.10	5.50 ± 0.05	4.00 ± 0.10	mm
Type / Code	P1	P2	D0	D1	T	Unit	
MLFA13	0.157 ± 0.004	0.079 ± 0.002	0.059 ± 0.004	0.035 min.	0.059 ± 0.004	inches	
	4.00 ± 0.10	2.00 ± 0.05	1.50 ± 0.10	0.90 min.	1.50 ± 0.10	mm	
MLFA25	0.157 ± 0.004	0.079 ± 0.002	0.059 ± 0.004	0.035 min.	0.071 ± 0.004	inches	
	4.00 ± 0.10	2.00 ± 0.05	1.50 ± 0.10	0.90 min.	1.80 ± 0.10	mm	
MLFA1	0.157 ± 0.004	0.079 ± 0.002	0.059 ± 0.004	0.055 min.	0.106 ± 0.004	inches	
	4.00 ± 0.10	2.00 ± 0.05	1.50 ± 0.10	1.40 min.	2.70 ± 0.10	mm	

Recommended Pad Layout				
Type / Code	A	B	C	Unit
MLFA13	0.039	0.031	0.059	inches
	1.00	0.80	1.50	mm
MLFA25	0.063	0.047	0.063	inches
	1.60	1.20	1.60	mm
MLFA1	0.118	0.067	0.094	inches
	3.00	1.70	2.40	mm

Soldering Condition:

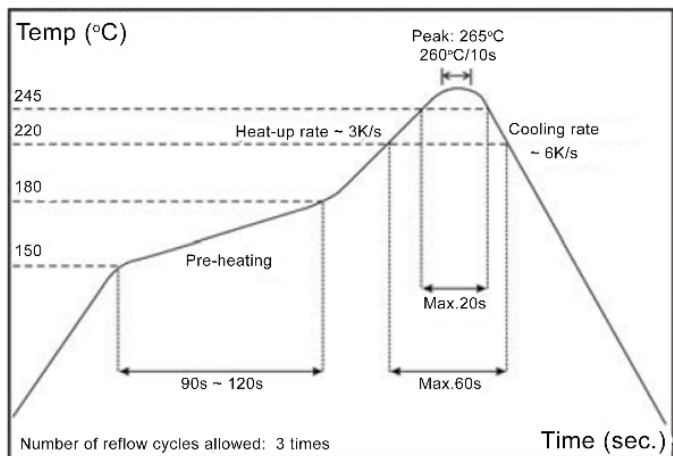

IR Reflow Soldering

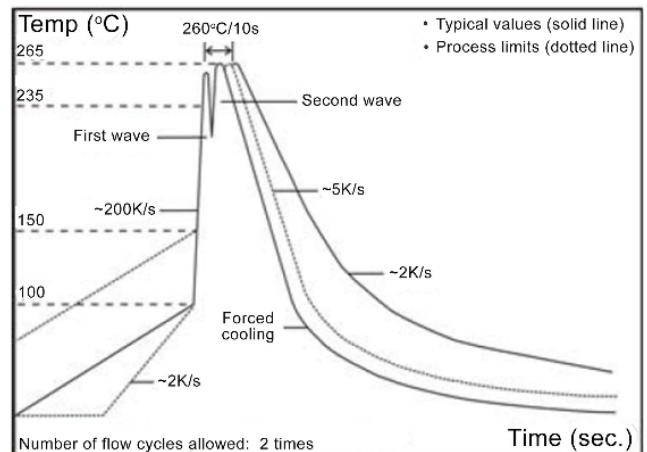

Wave Soldering (Flow Soldering)

- (1) Time of IR reflow soldering at maximum temperature point 260°C : 10 seconds
- (2) Time of wave soldering at maximum temperature point 260°C : 10 seconds
- (3) Time of soldering iron at maximum temperature point 410°C : 5 seconds

Pulse Withstanding Capacity

The single impulse graph is the result of the impulse of rectangular shape applied. The limit of acceptance was a shift in resistance of less than 1% from the initial value. The power applied was subject to the restrictions of the maximum permissible impulse voltage graph shown.

MLFA Series Single Pulse (R < 10 ohm)

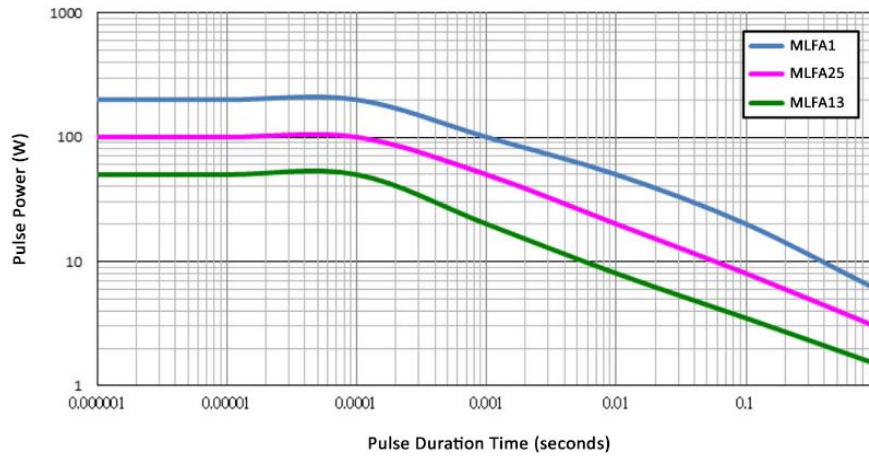

MLFA Series Single Pulse (R ≥ 10 ohm)

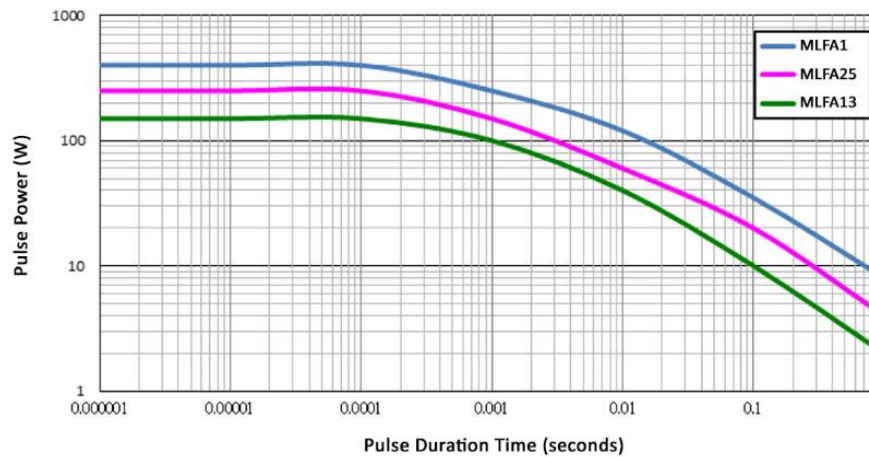

Continuous Pulse

The continuous load graph was obtained by applying repetitive rectangular pulses where the pulse period was adjusted so that the average power dissipated in the resistor was equal to its rated power at 70 °C. Again the limit of acceptance was a shift in resistance of less than 1% from the initial value.

MLFA Series Continuous Pulse (R < 10 ohm)

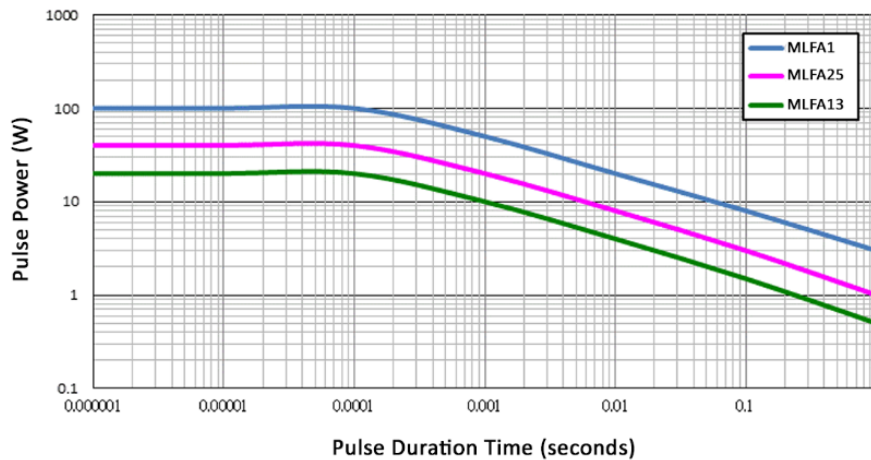

MLFA Series Continuous Pulse (R ≥ 10 ohm)

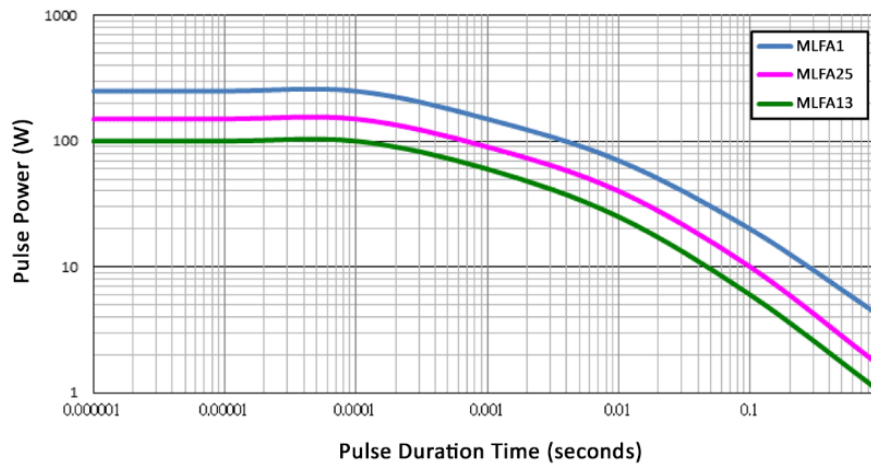

Frequency Behavior

Resistors are designed to function according to Ohmic laws. This is basically true of resistors for frequencies up to 100 kHz. At higher frequencies, there is an additional contribution to the impedance by an ideal resistor switched in series with a coil and both switched parallel to a capacitor. The values of the capacitance and inductance are mainly determined by the dimensions of the terminations and the conductive path length. The environment surrounding components has a large influence on the behavior of the component on the printed-circuit board.

MLFA25 Frequency versus Impedance

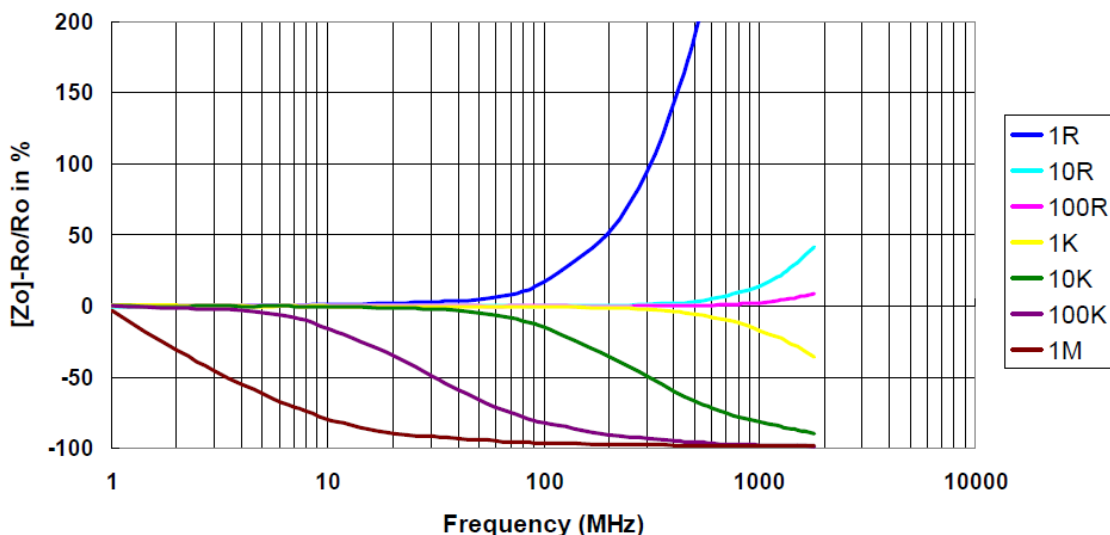

MLFA25 Frequency versus Phase Angle

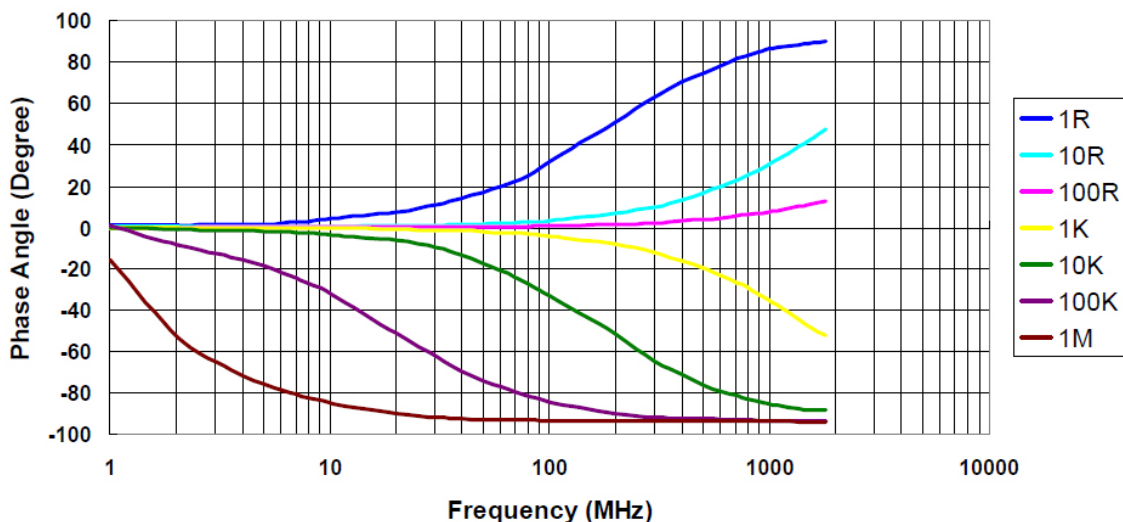

MLFA1 Frequency versus Impedance

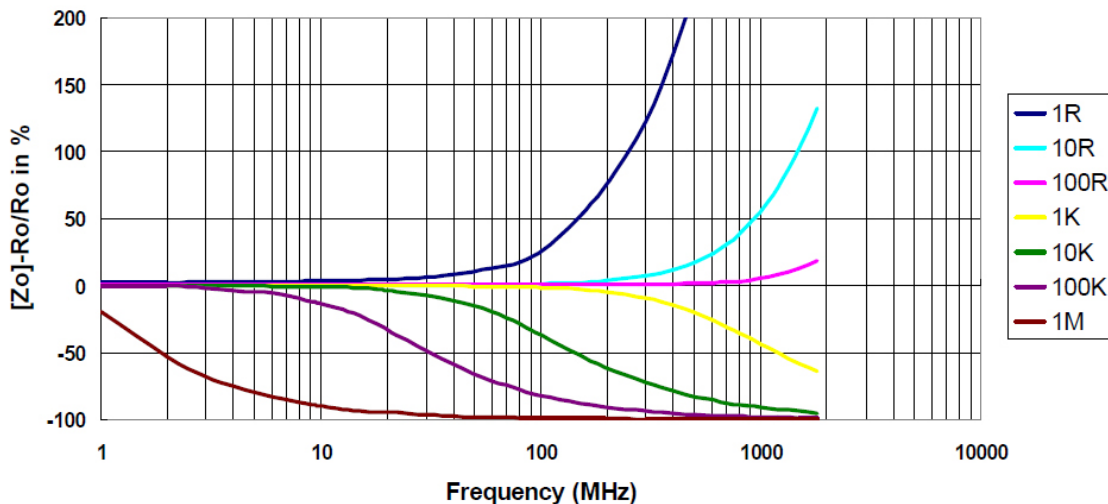

MLFA1 Frequency versus Phase Angle

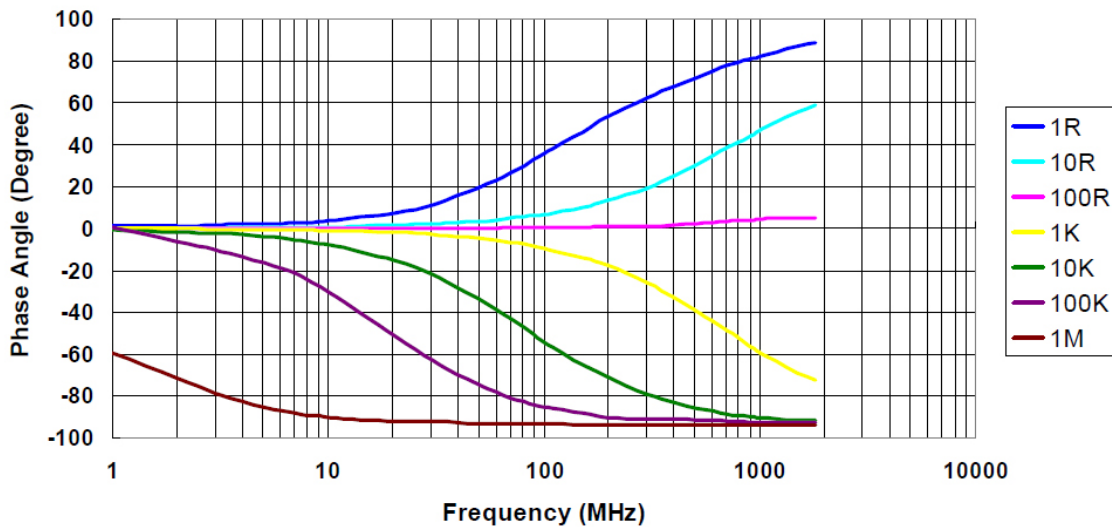

Lightning Surge

Resistors are tested in accordance with IEC 60 115-1 using both 1.2 / 50 μ s and 10 / 700 μ s pulse shapes. The limit of acceptance is a shift in resistance of less than 0.5% from the initial value.

MLFA25 / MLFA1 1.2 / 50 μ s Lightning Surge

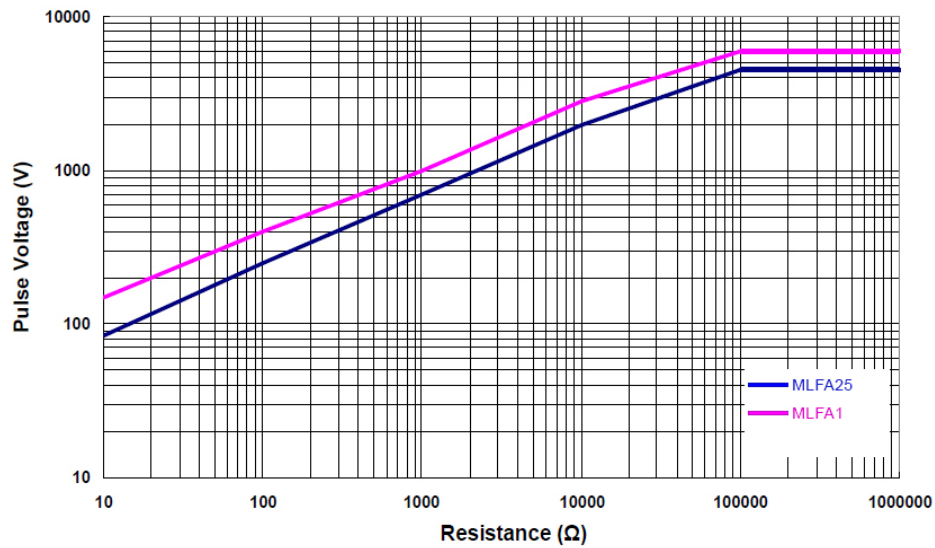

10 / 700 μ s Lightning Surge

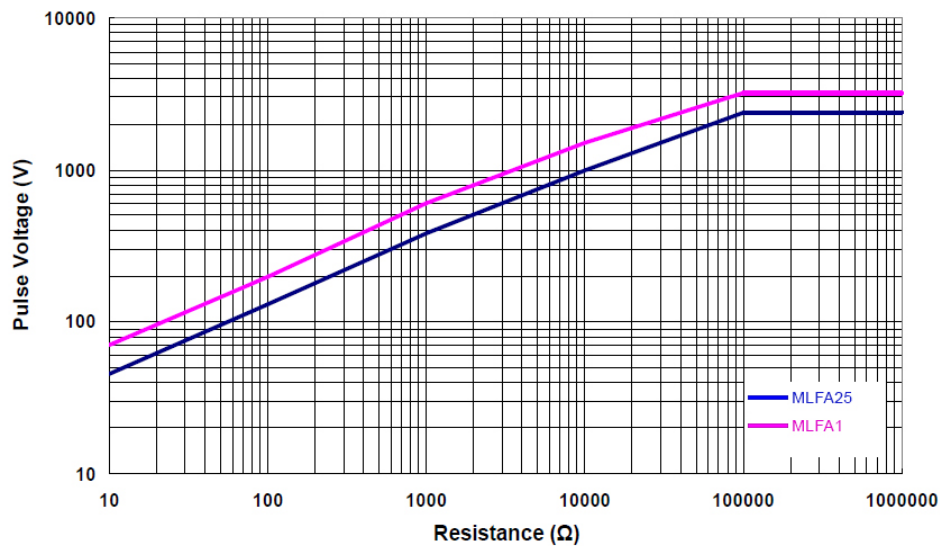

MLFA13 1.2 / 50 μ s Lightning Surge

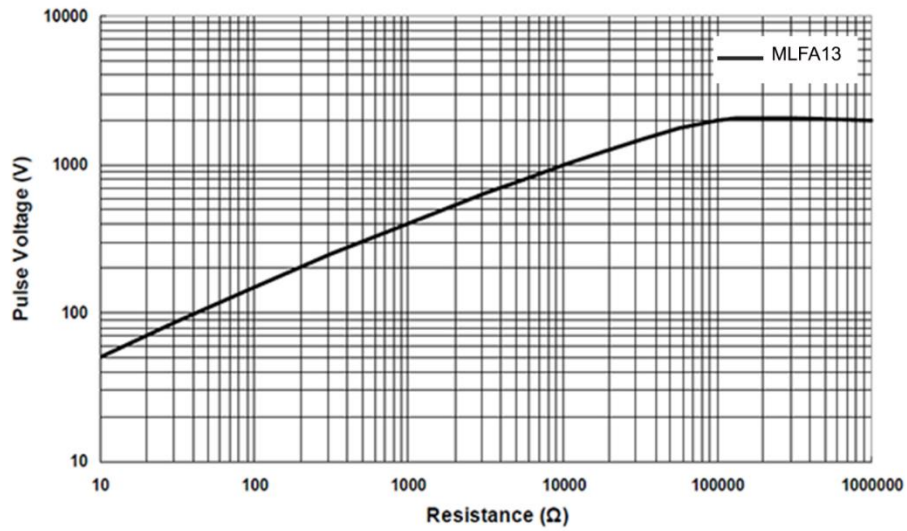

MLFA13 10 / 700 μ s Lightning Surge

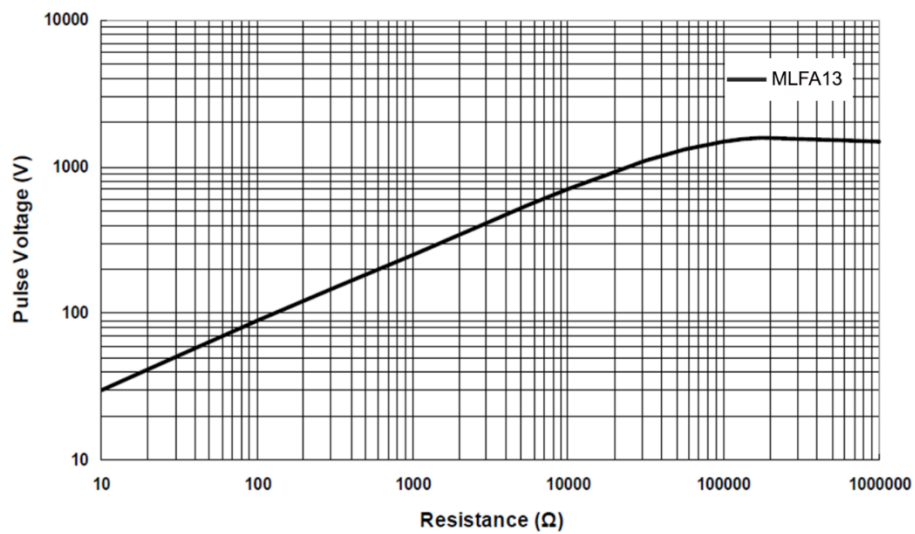

RoHS Compliance

Stackpole Electronics has joined the worldwide effort to reduce the amount of lead in electronic components and to meet the various regulatory requirements now prevalent, such as the European Union’s directive regarding “Restrictions on Hazardous Substances” (RoHS 3). As part of this ongoing program, we periodically update this document with the status regarding the availability of our compliant components. All our standard part numbers are compliant to EU Directive 2011/65/EU of the European Parliament as amended by Directive (EU) 2015/863/EU as regards the list of restricted substances.

RoHS Compliance Status						
Standard Product Series	Description	Package / Termination Type	Standard Series RoHS Compliant	Lead-Free Termination Composition	Lead-Free Mfg. Effective Date (Std Product Series)	Lead-Free Effective Date Code (YY/WW)
MLFA	Metal Film Melf Resistor (AEC-Q200 Qualified)	SMD	YES	100% Matte Sn	Always	Always

Conflict Metals” Commitment

We at Stackpole Electronics, Inc. are joined with our industry in opposing the use of metals mined in the “conflict region” of the eastern Democratic Republic of the Congo (DRC) in our products. Recognizing that the supply chain for metals used in the electronics industry is very complex, we work closely with our own suppliers to verify to the extent possible that the materials and products we supply do not contain metals sourced from this conflict region. As such, we are in compliance with the requirements of Dodd-Frank Act regarding Conflict Minerals.

Compliance to “REACH”

We certify that all passive components supplied by Stackpole Electronics, Inc. are SVHC (Substances of Very High Concern) free and compliant with the requirements of EU Directive 1907/2006/EC, “The Registration, Evaluation, Authorization and Restriction of Chemicals”, otherwise referred to as REACH. Contact us for complete list of REACH Substance Candidate List.

Environmental Policy

It is the policy of Stackpole Electronics, Inc. (SEI) to protect the environment in all localities in which we operate. We continually strive to improve our effect on the environment. We observe all applicable laws and regulations regarding the protection of our environment and all requests related to the environment to which we have agreed. We are committed to the prevention of all forms of pollution.

How to Order

