

MODEL CUB5T - MINIATURE ELECTRONIC PRESET TIMER AND CYCLE COUNTER



- LCD, REFLECTIVE OR RED/GREEN LED BACKLIGHTING
- 0.46" (11.7 mm) HIGH DIGITS
- 7-DIGIT BI-DIRECTIONAL TIMING CAPABILITY
- 6-DIGIT CYCLE COUNTING CAPABILITY
- OPTIONAL RELAY OUTPUT MODULE
- OPTIONAL SERIAL COMMUNICATIONS MODULE (RS232 or RS485)
- SELECTABLE TIMER RANGES AND OPERATING MODES
- ELAPSED TIMER AND PRESET TIMER FUNCTIONALITY
- DISPLAY COLOR CHANGE CAPABILITY AT PRESET OUTPUT
- OPERATES FROM 9 TO 28 VDC POWER SOURCE
- NEMA 4X/IP65 SEALED FRONT BEZEL

GENERAL DESCRIPTION

The CUB5T provides the ultimate in timer flexibility, from its complete user programming to the optional relay output and serial communications capability. The meter functions as an Elapsed Timer or Preset Timer. It also has a built-in Cycle Counter. The display can be toggled either manually or automatically between the Timer and Cycle Counter values. With eight different input operating modes and 18 selectable timer ranges, the meter can be programmed for a wide variety of timing applications.

The CUB5T has an LCD display with 0.46" (11.7 mm) high digits. The LCD is available in two versions, reflective (CUB5TR00) and backlight (CUB5TB00). The backlight version is user selectable for red or green backlighting with variable display intensity.

The Timer has two signal inputs and eight input operating modes. These modes provide level active or edge triggered start/stop operation. A Display Hold mode will display the elapsed time for one cycle, while the next cycle continues timing internally. The Timer Reset modes will automatically reset the timer value when a time start edge is applied to the input. This allows sequential timing cycles without having to manually reset the Timer.

In addition to the Timer inputs, a programmable User Input is available to perform a variety of meter functions. All inputs are current sinking (active low) and accept a variety of logic and open-collector output signal sources. Relay and switch contacts can also be used as signal sources, when the software input debounce filter is enabled.

The capability of the CUB5T can be easily expanded with the addition of a field installable option module. When the CUB5RLY0 relay output module is added, the meter becomes a Preset Timer. The Setpoint Output can be assigned to the Timer or Cycle Counter values, and configured to suit a variety of control and alarm requirements. Serial communications capability for RS232 or RS485 is added with a serial option module (CUB5COM).

The CUB5T can be powered from an optional Red Lion Micro-Line/Sensor Power Supply (MLPS), which attaches directly to the back of a CUB5T. The MLPS is powered from an 85 to 250 VAC source and provides up to 400 mA to drive the meter and sensors.

SAFETY SUMMARY

All safety related regulations, local codes and instructions that appear in this literature or on equipment must be observed to ensure personal safety and to prevent damage to either the instrument or equipment connected to it. If equipment is used in a manner not specified by the manufacturer, the protection provided by the equipment may be impaired.

Do not use this meter to directly command motors, valves, or other actuators not equipped with safeguards. To do so can be potentially harmful to persons or equipment in the event of a fault to the meter.



CAUTION: Risk of Danger.
 Read complete instructions prior to installation and operation of the unit.



CAUTION: Risk of electric shock.

DIMENSIONS In inches (mm)

Note: Recommended minimum clearance (behind the panel) for mounting clip installation is 2.15" (54.6) H x 3.00" (76.2) W.

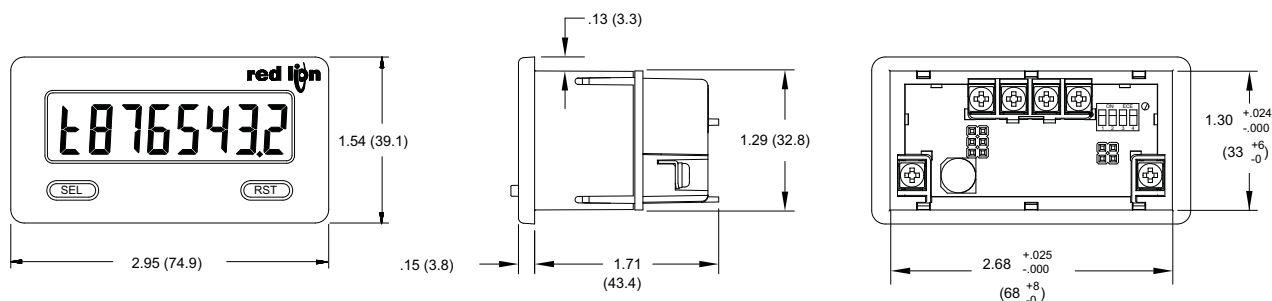

ORDERING INFORMATION

TYPE	MODEL NO.	DESCRIPTION	PART NUMBER
CUB5	CUB5TR	Preset Timer and Cycle Counter with Reflective Display	CUB5TR00
	CUB5TB	Preset Timer and Cycle Counter with Backlight Display	CUB5TB00
Optional Plug-in Cards	CUB5RLY	Single Relay Option Card	CUB5RLY0
	CUB5COM	RS485 Serial Communications Card	CUB5COM1
		RS232 Serial Communications Card	CUB5COM2
Accessories	MLPS	+12 VDC Micro-Line Power Supply, 85 to 250 VAC source, 400 mA max out	MLPS1000
		+24 VDC Micro-Line Power Supply, 85 to 250 VAC source, 200 mA max out	MLPS2000
	CBLPROG	Programming Cable RS232 (RJ11-DB9)	CBLPROG0
	CBPRO	Programming Cable RS485 (RJ11-DB9)	CBPRO007

GENERAL METER SPECIFICATIONS

- DISPLAY:** 8 digit LCD 0.46" (11.7 mm) high digits
CUB5TR00: Reflective LCD with full viewing angle
CUB5TB00: Selectable transmissive red or green backlight LED with viewing angle optimized. Display color change capability at preset when using a relay module.
- POWER:** Input voltage range is +9 to +28 VDC with short circuit and input polarity protection. Must use an RLC model MLPS or a Class 2 or SELV rated power supply.

MODEL NUMBER	DISPLAY COLOR	INPUT CURRENT WITHOUT CUB5RLY0	INPUT CURRENT WITH CUB5RLY0
CUB5TR00	---	10 mA	30 mA
CUB5TB00	Red (max intensity)	85 mA	115 mA
CUB5TB00	Green (max intensity)	95 mA	125 mA

- TIMER DISPLAY:** 7-digits
Display Designator: "t" to the left side of the display
Display Range: 0 to 9999999
Overflow/Underflow Indication: Display flashes "t Over"
Minimum Digit Resolution: 0.001 Sec.
Maximum Single Digit Resolution: 1 Hr.
Timing Accuracy: ±0.01%
- CYCLE COUNTER DISPLAY:** 6-digits, may be disabled if not used
Display Designator: "f" to the left side of the display
Display Range: 0 to 999999
Overflow/Underflow Indication: Display flashes "f Over"
Maximum Count Rate:
 All Count Sources except Input B: 10 Hz
 Input B Count Source:
 With Timer Input Filter ON: 10 Hz
 With Timer Input Filter OFF: 500 Hz
- TIMER SIGNAL INPUTS (INP A and INP B)**
 Logic Inputs, Current Sinking (active low)
Input A:
 Internal 7.8KΩ pull-up resistor to +9 to 28 VDC
 Trigger levels: $V_{IL} = 1.25$ V max; $V_{IH} = 2.75$ V min; $V_{MAX} = 28$ VDC
Input B:
 Internal 10KΩ pull-up resistor to +9 to 28 VDC
 Trigger levels: $V_{IL} = 0.7$ V max; $V_{IH} = 2.4$ V min; $V_{MAX} = 28$ VDC
Inputs A and B:
 Timer Input Pulse Width: 1 msec min.
 Timer Start/Stop Response Time: 1 msec max.
 Filter: Software filtering provided for relay or switch contact debounce.
 Filter enabled or disabled through programming. If enabled, results in 50 msec start/stop response time for successive pulses applied to the same input terminal.
- USER INPUT (USR):** Programmable function input
 Logic Input, Current Sinking (active low)
 Internal 10KΩ pull-up resistor to +9 to 28 VDC
Trigger levels: $V_{IL} = 0.7$ V max; $V_{IH} = 2.4$ V min; $V_{MAX} = 28$ VDC
Response Time: 5 msec typ.; 50 msec debounce (activation and release)
- MEMORY:** Nonvolatile E²PROM memory retains all programming parameters and timer/counter values when power is removed.
- CONNECTIONS:** Wire clamping screw terminals
Wire Strip Length: 0.3" (7.5 mm)
Wire Gauge: 30-14 AWG copper wire
Torque: 5 inch-lbs (0.565 N-m) max.
- ENVIRONMENTAL CONDITIONS:**
Operating Temperature Range for CUB5TR00: -35 to 75°C
Operating Temperature Range for CUB5TB00 depends on display color

and intensity level as per below:

	INTENSITY LEVEL	TEMPERATURE
Red Display	1 & 2	-35 to 75°C
	3	-35 to 70°C
	4	-35 to 60°C
	5	-35 to 50°C
Green Display	1 & 2	-35 to 75°C
	3	-35 to 65°C
	4	-35 to 50°C
	5	-35 to 35°C

Storage Temperature: -35 to 85°C

Operating and Storage Humidity: 0 to 85% max. relative humidity (non-condensing)

Vibration According to IEC 68-2-6: Operational 5 to 500 Hz, in X, Y, Z direction for 1.5 hours, 5 g.

Shock According to IEC 68-2-27: Operational 40 g, 11 msec in 3 directions.

Altitude: Up to 2000 meters

10. CERTIFICATIONS AND COMPLIANCES:

SAFETY

UL Recognized Component, File #E179259, UL61010A-1, CSA 22.2 No. 61010-1 Recognized to U.S. and Canadian requirements under the Component Recognition Program of Underwriters Laboratories, Inc.

UL Listed, File # E137808, UL508, CSA C22.2 No. 14-M95

LISTED by Und. Lab. Inc. to U.S. and Canadian safety standards

Type 4X Outdoor Enclosure rating (Face only), UL50

IECEE CB Scheme Test Report #E179259-V01-S02

Issued by Underwriters Laboratories, Inc.

IEC 61010-1, EN 61010-1: Safety requirements for electrical equipment for measurement, control, and laboratory use, Part 1.

IP65 Enclosure rating (Face only), IEC 529

ELECTROMAGNETIC COMPATIBILITY

Emissions and Immunity to EN 61326: Electrical Equipment for Measurement, Control and Laboratory use.

Immunity to Industrial Locations:

Electrostatic discharge	EN 61000-4-2	Criterion A 4 kV contact discharge 8 kV air discharge
Electromagnetic RF fields	EN 61000-4-3	Criterion A 10 V/m
Fast transients (burst)	EN 61000-4-4	Criterion A 2 kV power 1 kV signal
Surge	EN 61000-4-5	Criterion A 1 kV L-L, 2 kV L&N-E power
RF conducted interference	EN 61000-4-6	Criterion A 3 V/rms
Power frequency magnetic fields	EN 61000-4-8	Criterion A 30 A/m

Emissions:

Emissions EN 55011 Class A

Notes:

1. Criterion A: Normal operation within specified limits.

Refer to EMC Installation Guidelines for additional information.

11. **CONSTRUCTION:** This unit is rated for NEMA 4X/IP65 requirements for outdoor use. Installation Category I, Pollution Degree 2. High impact plastic case with clear viewing window. Panel gasket and mounting clip included.

12. **WEIGHT:** 3.2 oz (100 g)

OPTIONAL PLUG-IN CARDS

ADDING OPTION CARDS

The CUB5T meters can be fitted with optional relay card and/or serial communications cards. The details for the plug-in cards can be reviewed in the specification section below. The plug-in cards, that are sold separately, can be installed initially or at a later date.

RELAY CARD

- Type:** Single FORM-C relay
- Isolation To Sensor & User Input Commons:** 1400 Vrms for 1 min.
- Working Voltage:** 150 Vrms
- Contact Rating:** 1 amp @ 30 VDC resistive; 0.3 amp @ 125 VAC resistive
- Life Expectancy:** 100,000 minimum operations
- Response Time:**
 - Turn On Time: 4 msec max.
 - Turn Off Time: 4 msec max.
- Time Accuracy:** $\pm 0.01\%$



WARNING: Disconnect all power to the meter before installing Plug-in card.

RS485 SERIAL COMMUNICATIONS CARD

- Type:** RS485 multi-point balanced interface (non-isolated)
- Baud Rate:** 300 to 38400
- Data Format:** 7/8 bits; odd, even, or no parity
- Bus Address:** 0 to 99; max 32 meters per line
- Transmit Delay:** Selectable. 2 msec min. or 50 msec min.

RS232 SERIAL COMMUNICATIONS CARD

- Type:** RS232 half duplex (non-isolated)
- Baud Rate:** 300 to 38400
- Data Format:** 7/8 bits; odd, even, or no parity

1.0 INSTALLING THE METER

INSTALLATION

The meter meets NEMA 4X/IP65 requirements when properly installed. The unit is intended to be mounted into an enclosed panel. Prepare the panel cutout to the dimensions shown. Remove the panel latch from the unit. Slide the panel gasket over the rear of the unit to the back of the bezel. The unit should be installed fully assembled. Insert the unit into the panel cutout.

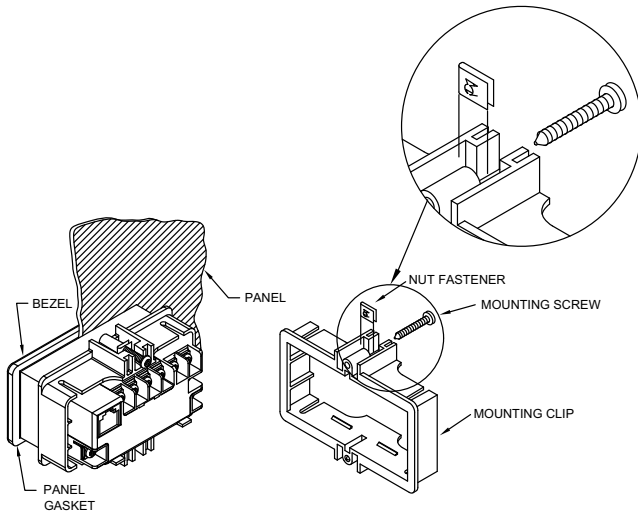

While holding the unit in place, push the panel latch over the rear of the unit so that the tabs of the panel latch engage in the slots on the case. The panel latch should be engaged in the farthest forward slot possible. To achieve a proper seal, tighten the latch screws evenly until the unit is snug in the panel (Torque to approx. 28 to 36 in-oz [0.202 to 0.26 N-m]). Do not over-tighten the screws.

INSTALLATION ENVIRONMENT

The unit should be installed in a location that does not exceed the operating temperature and provides good air circulation. Placing the unit near devices that generate excessive heat should be avoided.

The bezel should only be cleaned with a soft cloth and neutral soap product. Do NOT use solvents. Continuous exposure to direct sunlight may accelerate the aging process of the bezel.

Do not use tools of any kind (screwdrivers, pens, pencils, etc.) to operate the keypad of the unit.

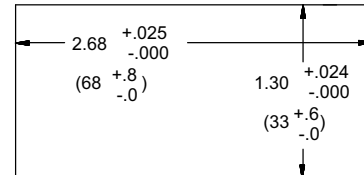

2.0 DIP SWITCHES

The DIP switches on the main circuit board are not used with the CUB5T and must be left in the factory set position (all down). Setting any switch to the up position may cause improper operation of the meter.

3.0 INSTALLING PLUG-IN CARDS

The Plug-in cards are separately purchased option cards that perform specific functions. The cards plug into the main circuit board of the meter after the rear cover is removed.



WARNING: Disconnect all power to the meter before installing Plug-in Card.

REMOVING THE REAR COVER

To remove the rear cover, locate the cover locking tab below the 2nd and 3rd input terminals. To release the tab, insert a small, flat blade screwdriver between the tab and the plastic wall below the terminals. Inserting the screwdriver will provide enough pressure to release the tab locks. To replace the cover, align the cover with the input terminals and press down until the cover snaps into place.

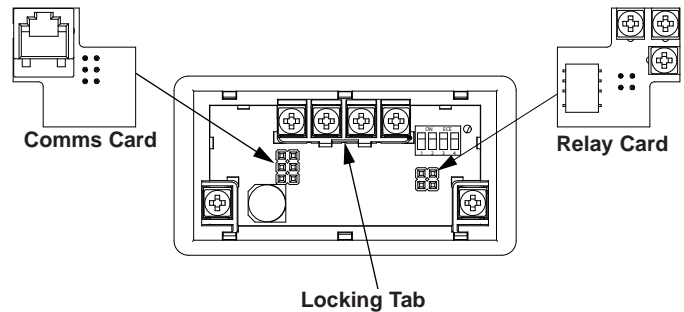

CAUTION: The Plug-in cards and main circuit board contain static sensitive components. Before handling the cards, discharge static charges from your body by touching a grounded bare metal object. Ideally, handle the cards at a static controlled clean workstation. Also, only handle the cards by the edges. Dirt, oil or other contaminants that may contact the cards can adversely affect circuit operation.

4.0 WIRING THE METER

WIRING OVERVIEW

Electrical connections are made via screw-clamp terminals located on the back of the meter. All conductors should conform to the meter's voltage and current ratings. All cabling should conform to appropriate standards of good installation, local codes and regulations. It is recommended that the power supplied to the meter (DC or AC) be protected by a fuse or circuit breaker.

Strip the wire, leaving approximately 0.3" (7.5 mm) bare lead exposed (stranded wires should be tinned with solder.) Insert the lead under the correct screw-clamp terminal and tighten until the wire is secure. (Pull wire to verify tightness.) Each terminal can accept up to one #14 AWG (2.55 mm) wire, two #18 AWG (1.02 mm), or four #20 AWG (0.61 mm).

EMC INSTALLATION GUIDELINES

Although this meter is designed with a high degree of immunity to Electro-Magnetic Interference (EMI), proper installation and wiring methods must be followed to ensure compatibility in each application. The type of the electrical noise, source or coupling method into the meter may be different for various installations. The meter becomes more immune to EMI with fewer I/O connections. Cable length, routing, and shield termination are very important and can mean the difference between a successful or troublesome installation. Listed below are some EMC guidelines for successful installation in an industrial environment.

1. The meter should be mounted in a metal enclosure, which is properly connected to protective earth.
2. Use shielded (screened) cables for all Signal and Control inputs. The shield (screen) pigtail connection should be made as short as possible. The connection point for the shield depends somewhat upon the application. Listed below are the recommended methods of connecting the shield, in order of their effectiveness.
 - a. Connect the shield only at the panel where the unit is mounted to earth ground (protective earth).
 - b. Connect the shield to earth ground at both ends of the cable, usually when the noise source frequency is above 1 MHz.
 - c. Connect the shield to common of the meter and leave the other end of the shield unconnected and insulated from earth ground.
3. Never run Signal or Control cables in the same conduit or raceway with AC power lines, conductors feeding motors, solenoids, SCR controls, and heaters, etc. The cables should be ran in metal conduit that is properly grounded. This is especially useful in applications where cable runs are long and portable two-way radios are used in close proximity or if the installation is near a commercial radio transmitter.
4. Signal or Control cables within an enclosure should be routed as far as possible from contactors, control relays, transformers, and other noisy components.

5. In extremely high EMI environments, the use of external EMI suppression devices, such as ferrite suppression cores, is effective. Install them on Signal and Control cables as close to the unit as possible. Loop the cable through the core several times or use multiple cores on each cable for additional protection. Install line filters on the power input cable to the unit to suppress power line interference. Install them near the power entry point of the enclosure. The following EMI suppression devices (or equivalent) are recommended:

Ferrite Suppression Cores for signal and control cables:

Fair-Rite # 0443167251 (RLC# FCOR0000)

TDK # ZCAT3035-1330A

Steward # 28B2029-0A0

Line Filters for input power cables:

Schaffner # FN610-1/07 (RLC# LFIL0000)

Schaffner # FN670-1.8/07

Corcom # 1 VR3

Note: Reference manufacturer's instructions when installing a line filter.

6. Long cable runs are more susceptible to EMI pickup than short cable runs. Therefore, keep cable runs as short as possible.
7. Switching of inductive loads produces high EMI. Use of snubbers across inductive loads suppresses EMI.
Snubber: RLC# SNUB0000.

4.1 POWER WIRING

DC Power

+9 to +28 VDC: +VDC
Power Common: -VDC

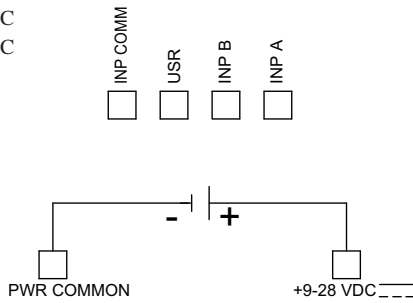

4.2 USER INPUT WIRING

Sinking Logic

INP COMM } Connect external switching device between the
USR } User Input terminal and Input Common.

The user input of the meter is internally pulled up to +9 to +28 V with 10 K resistance. The input is active when it is pulled low.

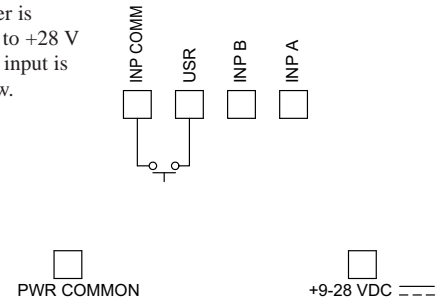

4.3 INPUT WIRING



CAUTION: Power input common is NOT isolated from user input common. In order to preserve the safety of the meter application, the power input common must be suitably isolated from hazardous live earth referenced voltage; or input common must be at protective earth ground potential. If not, hazardous voltage may be present at the User Inputs and User Input Common terminals. Appropriate considerations must then be given to the potential of the user input common with respect to earth ground; and the common of the plug-in cards with respect to input common.

Current Sinking Output

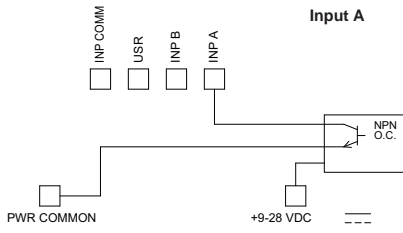

Interfacing With TTL

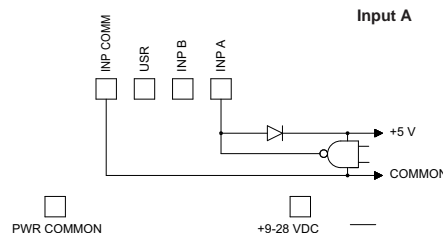

Switch or Isolated Transistor; Current Sink

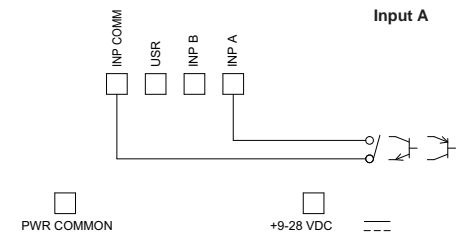

4.4 SETPOINT (OUTPUT) WIRING



4.5 SERIAL COMMUNICATION WIRING

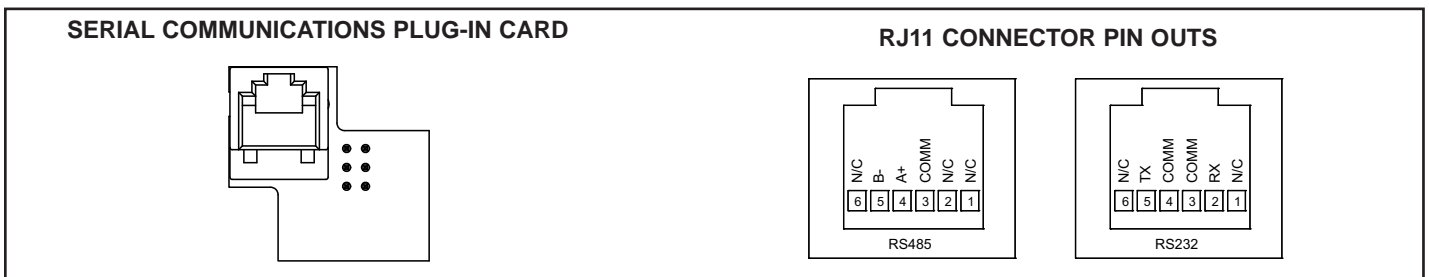

5.0 REVIEWING THE FRONT BUTTONS AND DISPLAY

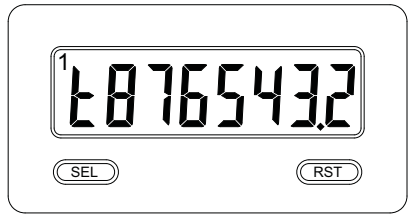

KEY	DISPLAY MODE OPERATION	ENTERING PROGRAM MODE	PROGRAMMING MODE OPERATION
SEL	Select display (timer or cycle counter)	Press and hold for 2 seconds to activate	Store selected parameter and index to next parameter
RST	Reset value(s) per Front Panel Reset setting		Advances through the program menu Increments selected parameter value or selection

OPERATING MODE DISPLAY DESIGNATORS

- "1" - To the left of the display is the timer value.
- "1" - To the upper left of the display indicates the setpoint status.
- "C" - To the left of the display is the cycle counter value.

If display scroll is enabled, the display will toggle automatically every four seconds between the timer and cycle counter values.

6.0 PROGRAMMING THE METER

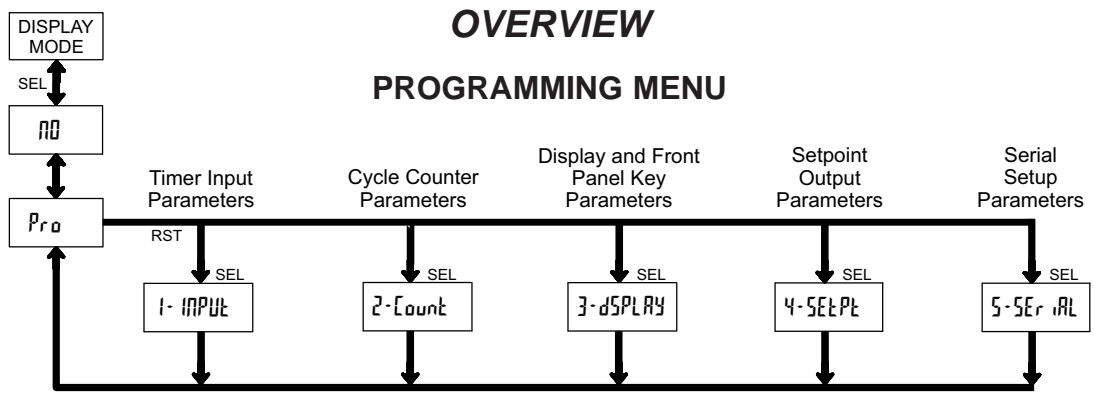

PROGRAMMING MODE ENTRY (SEL KEY)

It is recommended all programming changes be made off line, or before installation. The meter normally operates in the Display Mode. No parameters can be programmed in this mode. The Programming Mode is entered by pressing and holding the SEL key. If it is not accessible, then it is locked by either a security code, or a hardware lock (See Module 3).

MODULE ENTRY (SEL & RST KEYS)

The Programming Menu is organized into separate modules. These modules group together parameters that are related in function. The display will alternate between Prd and the present module. The RST key is used to select the desired module. The displayed module is entered by pressing the SEL key.

MODULE MENU (SEL KEY)

Each module has a separate module menu (which is shown at the start of each module discussion). The SEL key is pressed to advance to a particular parameter to be changed, without changing the programming of preceding parameters. After completing a module, the display will return to Prd. Programming may continue by accessing additional modules.

SELECTION / VALUE ENTRY

For each parameter, the display alternates between the present parameter and the selections/value for that parameter. The RST key is used to move through the selections/values for that parameter. Pressing the SEL key, stores and activates the displayed selection/value. This also advances the meter to the next parameter.

For numeric values, press the RST key to change the value. The right hand most digit will begin to flash. Pressing the RST key again increments the digit by one or the user can hold the RST key and the digit will automatically scroll. The SEL key will advance to the next digit. Pressing and holding the SEL key will enter the value and move to the next parameter.

PROGRAMMING MODE EXIT (SEL KEY)

The Programming Mode is exited by pressing the SEL key with Prd displayed. This will commit any stored parameter changes to memory and return the meter to the Display Mode. (If power loss occurs before returning to the Display Mode, verify recent parameter changes.)

PROGRAMMING TIPS

It is recommended to start with Module 1 and proceed through each module in sequence. When programming is complete, it is recommended to record the parameter programming and lock out parameter programming with the user input or programming security code.

FACTORY SETTINGS

Factory Settings may be completely restored in Module 3. This is useful when encountering programming problems.

Pressing the RST key on power-up will load the factory settings and display rESt. This allows operation in the event of a memory failure or corrupted data.

ALTERNATING SELECTION DISPLAY

In the explanation of the modules, the following dual display with arrows will appear. This is used to illustrate the display alternating between the parameter on top and the parameter's Factory Setting on the bottom. In most cases, selections and values for the parameter will be listed on the right.

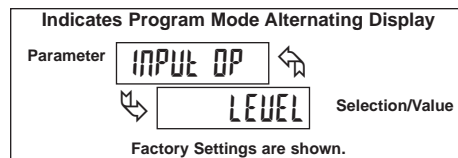

6.1 MODULE 1 - TIMER INPUT PARAMETERS (1- INPUT)

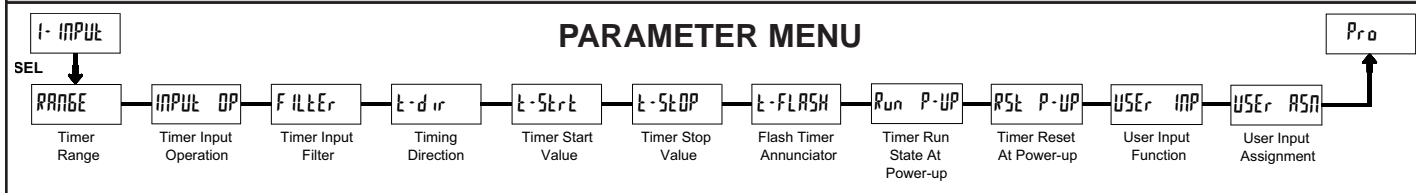

TIMER RANGE



18 TIMER RANGE SELECTIONS
(S = SEC; M = MIN; H = HR; d = DAY)

RANGE SELECTION	MAXIMUM DISPLAY	DISPLAY RESOLUTION	RANGE SELECTION	MAXIMUM DISPLAY	DISPLAY RESOLUTION
SECONDS					
5555555	9999999	1 SEC	MINUTES/SECONDS	9999959	1 SEC
5555555	9999999	0.1 SEC	MINUTES/SECONDS	9999599	0.1 SEC
5555555	9999999	0.01 SEC	MINUTES/SECONDS	9995999	0.01 SEC
5555555	9999999	0.001 SEC	HOURS/MINUTES		
MINUTES					
9999999	9999999	1 MIN	XXXXXXXX	9999959	1 MIN
9999999	9999999	0.1 MIN	XXXXXXXX	9999599	0.1 MIN
9999999	9999999	0.01 MIN	XXXXXXXX	9995999	0.01 MIN
HOURS					
XXXXXXXX	9999999	1 HR	HOURS/MINUTES/SECONDS		
XXXXXXXX	9999999	0.1 HR	XXXXXX55	9995959	1 SEC
XXXXXXXX	9999999	0.01 HR	DAYS/HOURS/MINUTES		
			dddXXXX	9992359	1 MIN

TIMER INPUT OPERATION

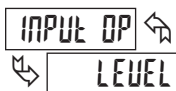

LEVEL EDGE-1 EDGE-2 HOLD-2
 LEV rSt Ed-1 rSt Ed-2 rSt HOLd rSt

This parameter determines how the Timer Input Signals affect the Run/Stop status of the Timer. Timing diagrams are shown below for level active and edge triggered (1-input or 2-input) operation. For single input modes (Input A only), Input B provides a level active Timer Inhibit function. In the Display Hold mode, the timer display value remains held and only updates when a Timer Start (Input A) or Timer Stop (Input B) edge occurs.

The timer reset (rSt) operating modes are identical to the other modes in the diagrams, except the timer display value is reset at the Time Start edges.

The Timer can also be stopped at a Timer Stop Value or at Setpoint output activation or deactivation. This type of Stop condition is cleared when a Timer Reset occurs, or another start edge is applied on the timer input.

For Reset Modes (rSt), the timer is reset at Time Start edge.

LEVEL, LEV rSt

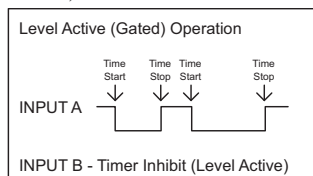

EDGE-1, Ed-1 rSt

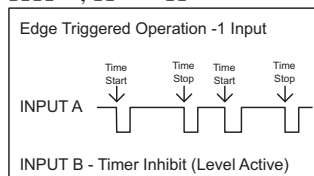

EDGE-2, Ed-2 rSt

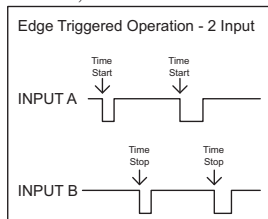

HOLD-2, HOLd rSt

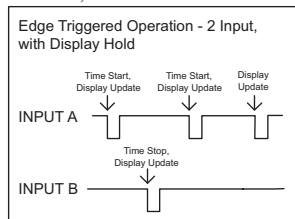

TIMER INPUT FILTER



ON OFF

Provides a 50 msec software debounce for the Timer Inputs (A and B). Select ON when using relays or switch contacts as a signal source.

TIMING DIRECTION

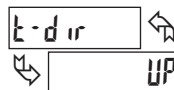

UP dn

Bi-directional timing capability. Select the timing direction desired for the application.

TIMER START VALUE

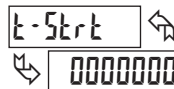

0000000 to 9999999

The Timer returns to this value whenever a Timer Reset occurs. The value is entered in the same display format as the Timer Range selected. Non-zero values are normally used for "timing down" applications, but they can also provide an offset value when timing up.

TIMER STOP VALUE



NO YES

The Timer stops when this value is reached regardless of the signal levels on the timer inputs. Selecting YES displays a sub-menu where the Stop Value is entered in the same display format as the Timer Range selected. This stop condition is cleared when a Timer Reset occurs or another start edge is applied on the timer input. Select NO if a Stop Value is not desired.



0000000 to 9999999

FLASH TIMER ANNUNCIATOR



NO YES

Select YES to have the timer annunciator (t) flash when the timer is running.

TIMER RUN STATE AT POWER-UP

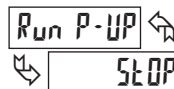

STOP SAVE

Determines the Run/Stop state of the Timer at Power-up. This parameter does not apply to LEVEL Input Operation.

STOP - Timer Stopped at power-up, regardless of prior Run/Stop state
 SAVE - Timer assumes the Run/Stop state it was in prior to power-down

TIMER RESET AT POWER-UP



The Timer can be programmed to Reset at each meter power-up.

USER INPUT FUNCTION (Cont'd)

DISPLAY	MODE	DESCRIPTION
Inhibit	Inhibit	Inhibit timing or counting for the selected value(s).
d-LEVEL	Display Intensity Level (Edge Triggered)	Increase intensity one level for each activation. (backlight version only)
Print	Print Request	Serial transmit of the active parameters selected in the Print Options menu (Module 5).
Print-Reset	Print and Reset	Same as Print Request followed by a momentary reset of the selected value(s).
Reset Out	Reset Output	Edge triggered deactivation of the Setpoint Output.

USER INPUT FUNCTION

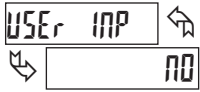

DISPLAY	MODE	DESCRIPTION
NO	No Function	User Input disabled.
Prog Loc	Program Mode Lock-out	See Programming Mode Access chart (Module 3).
d-SELECT	Display Select (Edge triggered)	Toggle display with each activation.
Reset	Maintained Reset	Level active reset of the selected value(s).
d-HOLD	Display Hold	Freeze display for the selected value(s) while allowing time or counts to accumulate internally.
HOLD-Reset	Hold and Reset	Edge triggered reset of the selected value(s) after storing the time or count.

USER INPUT ASSIGNMENT

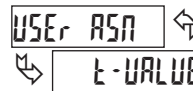

L-VALUE
E-VALUE
both L-E

The User Input Assignment only applies if the cycle counter is enabled and a selection of reset, display hold, hold and reset, inhibit, or print and reset is selected in the User Input Function menu.

6.2 MODULE 2 - CYCLE COUNTER PARAMETERS (2-Count)

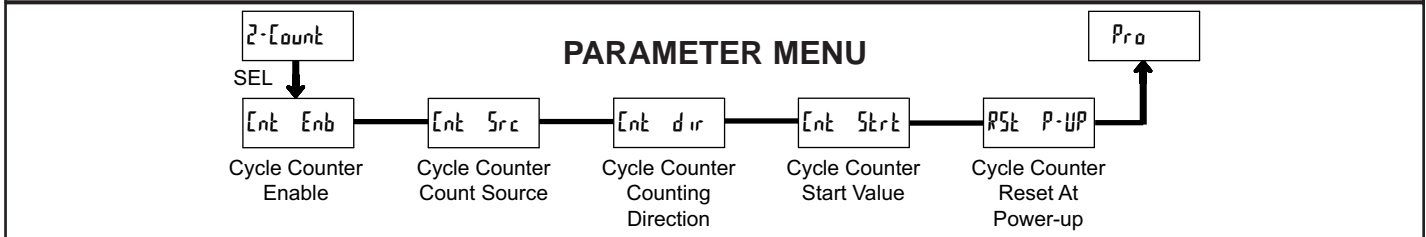

CYCLE COUNTER ENABLE



When set to NO, the remaining Cycle Counter parameters are not accessible.

CYCLE COUNTER COUNTING DIRECTION



Bi-directional counting capability. Select the counting direction desired for the application.

CYCLE COUNTER COUNT SOURCE



This parameter selects the source from which the Cycle Counter derives counts. The Timer Reset (t-RESET) selection generates a count when either a manual or automatic timer reset occurs (See Module 4 for programming Automatic Reset). The Input B (INPUT b) selection generates a count each time Input B is activated. This selection overrides the timer inhibit function of Input B, when the timer is programmed for Level or Edge-1 operating mode (See Module 1 for Timer Input Operating Modes).

The User Input (USR INP) selection generates a count each time the User Input is activated. When selected as the count source, the User Input can still be set to perform a User Function described in Module 1. In this case, the Cycle Counter will count the number of times the selected User Function occurred.

The Output ON/OFF selections generate a count when the Setpoint output either activates or deactivates. These selections will only generate counts when an optional Setpoint module is installed.

CYCLE COUNTER START VALUE



The Cycle Counter returns to this value whenever a Counter Reset occurs. Non-zero values are normally used for "down counting" applications, but can also provide an offset value when counting up.

CYCLE COUNTER RESET AT POWER-UP



The Cycle Counter can be programmed to Reset at each meter power-up.

6.3 MODULE 3 - DISPLAY AND FRONT PANEL KEY PARAMETERS (3-DISPLAY)

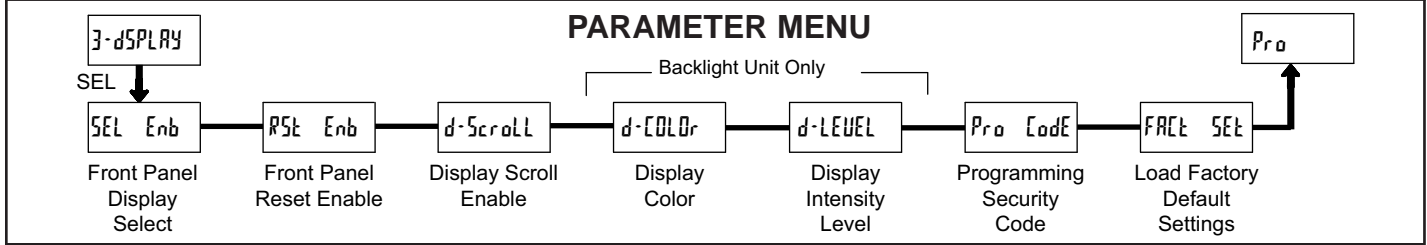

FRONT PANEL DISPLAY SELECT ENABLE (SEL)



The YES selection allows the SEL button to toggle between the timer and cycle counter displays.

FRONT PANEL RESET ENABLE (RST)

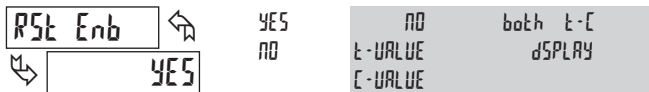

The YES selection allows the RST button to reset the selected value(s). The shaded selections only appear if the cycle counter is enabled.

DISPLAY SCROLL ENABLE



The YES selection allows the display to automatically scroll between the timer and cycle counter values. The scroll rate is about every 4 seconds.

DISPLAY COLOR (BACKLIGHT UNIT ONLY)

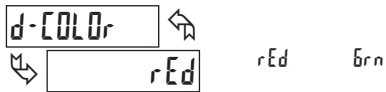

Enter the desired display color, red or green. This parameter is active for backlight units only.

DISPLAY INTENSITY LEVEL (BACKLIGHT UNIT ONLY)

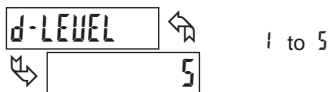

Enter the desired Display Intensity Level (1-5). The display will actively dim or brighten as levels are changed. This parameter is active for backlight units only.

PROGRAMMING SECURITY CODE

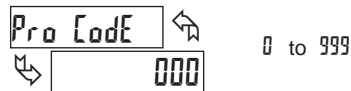

The Security Code determines the programming mode and the accessibility of programming parameters. This code can be used along with the Program Mode Lock-out (Pro Loc) in the User Input Function parameter (Module 1).

Two programming modes are available. Full Programming mode allows all parameters to be viewed and modified. Quick Programming mode permits only the Setpoint values and Timer Stop value to be modified, but allows direct access to these values without having to enter Full Programming mode.

Programming a Security Code other than 0, requires this code to be entered at the Pro CodE prompt in order to access Full Programming mode. Depending on the code value, Quick Programming may be accessible before the Pro CodE prompt appears (see chart).

USER INPUT FUNCTION	USER INPUT STATE	SECURITY CODE	MODE WHEN "SEL" KEY IS PRESSED	FULL PROGRAMMING MODE ACCESS
not Pro Loc	---	0	Full Programming	Immediate Access
		1-99	Quick Programming	After Quick Programming with correct code entry at Pro CodE prompt *
		100-999	Pro CodE prompt	With correct code entry at Pro CodE prompt *
Pro Loc	Active	0	Programming Lock	No Access
		1-99	Quick Programming	No Access
		100-999	Pro CodE prompt	With correct code entry at Pro CodE prompt *
	Not Active	0-999	Full Programming	Immediate Access

* Entering Code 222 allows access regardless of security code.

LOAD FACTORY DEFAULT SETTINGS



The YES selection will return the meter to the factory default settings. The meter will display rESEt and then return to Pro, at which time all settings have been changed.

Pressing the RST key on power-up will load the factory settings and display rESEt. This allows operation in the event of a memory failure or corrupted data.

6.4 MODULE 4 - SETPOINT OUTPUT PARAMETERS (4-SEtPt)

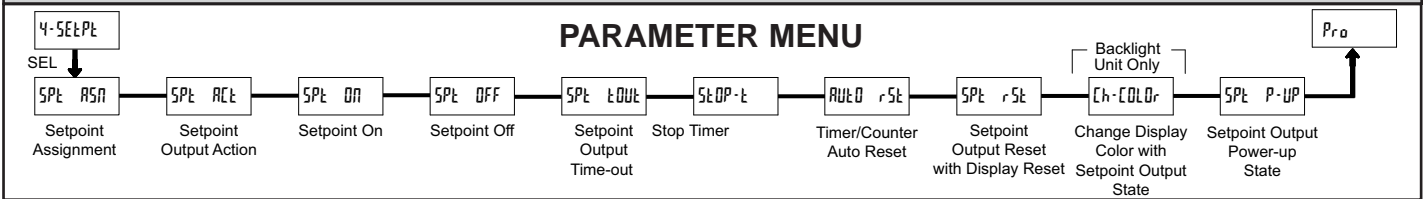

The Setpoint Output Parameters are only active when the optional relay module is installed in the meter. Some parameters will not appear depending on the Setpoint Assignment and Setpoint Output Action selected.

SETPOINT OUTPUT TIME-OUT



This parameter is only active if the Setpoint Action is set to Timed Output mode (t-OUt). Enter the time duration the Setpoint Output will remain ON once it is activated. This value is always entered in minutes, seconds, and hundredths of seconds format. The maximum value is 99 minutes 59.99 seconds.

SETPOINT ASSIGNMENT

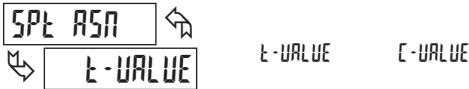

Select the display for Setpoint assignment.

SETPOINT OUTPUT ACTION



This parameter selects the action of the Setpoint output as shown below.

SPT ACTION	DESCRIPTION	OUTPUT ACTIVATES	OUTPUT DEACTIVATES
LATCH	Latched Output Mode	When Time or Count = Setpoint On value	At Manual Reset (if SPt rSt = YES)
t-OUt	Timed Output Mode	When Time or Count = Setpoint On value	After Setpoint Output Time-Out
ON-OFF	On-Off Output Mode	When Time or Count = Setpoint On value	When Time or Count = Setpoint Off value

SETPOINT ON



This parameter determines when the Setpoint output will activate. The output can activate at a programmed Setpoint Value or can be set to activate when the Timer starts (t-Start) or stops (t-STOP).

Selecting UVALUE displays a sub-menu where the Setpoint Value is entered. If the Setpoint is assigned to the Timer, the value is entered in the same display format as the selected Timer Range.



SETPOINT OFF



The Setpoint Off parameter only appears if the Setpoint Action is set to On-Off Output mode (ON-OFF). In this mode, the Setpoint OFF parameter determines when the Setpoint Output will deactivate. The output can be programmed to deactivate at a Setpoint Off Value or can be set to deactivate when the Timer starts (t-Start) or stops (t-STOP).

Selecting UVALUE displays a sub-menu where the Setpoint Off Value is entered. If the Setpoint is assigned to the Timer, the value is entered in the same display format as the selected Timer Range.



STOP TIMER

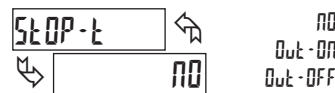

Stops the Timer when the Setpoint output activates (Out-ON) or deactivates (Out-OFF). Select NO if the output should not affect the Timer Run/Stop status.

The Timer Stop condition is cleared when a Timer Reset occurs, or a Time Start edge is applied on the Timer input.

TIMER/COUNTER AUTO RESET

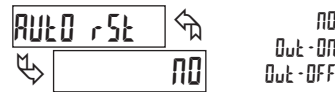

Automatically resets the Setpoint Assigned display value when the Setpoint Output activates (Out-ON) or deactivates (Out-OFF). Select NO if the output should not cause a display reset.

SETPOINT OUTPUT RESET WITH DISPLAY RESET



Select YES to have the Setpoint Output deactivate (reset) when the Setpoint Assigned display resets. Reset can occur by the RST button or the User Input, if programmed for that function. Select NO if the Setpoint output should not reset when the display resets.

CHANGE DISPLAY COLOR w/SETPOINT OUTPUT STATE



This parameter enables the backlight CUBST to switch the display color when the Setpoint output activates. When the output deactivates, the display color will revert to the normal operating mode color. This parameter is only active for the backlight version.

SETPOINT OUTPUT POWER-UP STATE

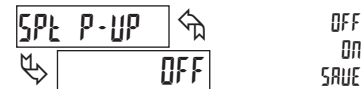

SAVE will restore the output to the same state it was at before the meter was powered down. ON will activate the output at power up. OFF will deactivate the output at power up. This parameter is not active when the Setpoint Action is selected for timed output mode.

6.5 MODULE 5 - SERIAL COMMUNICATIONS PARAMETERS (5-Serial)

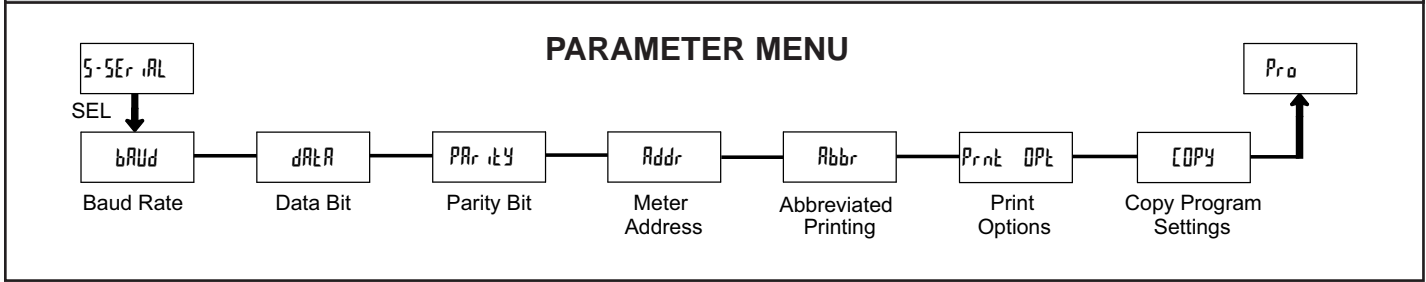

Module 5 is the programming module for the Serial Communications Parameters. These parameters are used to match the serial settings of the CUB5T with those of the host computer or other serial device. The Serial Setup Parameters are only accessible when an optional RS232 or RS485 serial communications module is installed in the meter.

This section replaces the bulletin shipped with the RS232 and RS485 serial communications plug-in cards. Discard the separate bulletin when using those serial plug-in cards with the CUB5T.

BAUD RATE

bAUD 300 1200 4800 19200
 600 2400 9600 38400
 9600

Set the baud rate to match that of other serial communications equipment. Normally, the baud rate is set to the highest value that all of the serial communications equipment is capable of transmitting and receiving.

DATA BIT

dATA 7-bit 8-bit
 7-bit

Select either 7- or 8-bit data word length. Set the word length to match the other serial communications equipment on the serial link.

PARITY BIT

PARity NO Odd EVEN
 Odd

This parameter only appears when the Data Bit parameter is set to a 7-bit data word length. Set the parity bit to match that of the other serial equipment on the serial link. The meter ignores parity when receiving data and sets the parity bit for outgoing data. If parity is set to NO, an additional stop bit is used to force the frame size to 10 bits.

METER ADDRESS

Addr 0 to 99
 00

Enter the serial node address. With a single unit, an address is not needed and a value of zero can be used (RS232 applications). Otherwise, with multiple bussed units, a unique address number must be assigned to each meter. The node address applies specifically to RS485 applications.

ABBREVIATED PRINTING

Abbr NO YES
 NO

This parameter determines the formatting of data transmitted from the meter in response to a Transmit Value command or a Block Print Request. Select NO for a full print transmission, consisting of the meter address, mnemonics, and parameter data. Select YES for abbreviated print transmissions, consisting of the parameter data only. This setting is applied to all the parameters selected in the PRINT OPTIONS. (Note: If the meter address is 0, the address will not be sent during a full transmission.)

PRINT OPTIONS

Prnt OPT NO YES
 NO

This parameter selects the meter values transmitted in response to a Print Request. A print request is also referred to as a block print because more than one parameter can be sent to a printer or computer as a block.

Selecting YES displays a sublist for choosing the meter parameters to appear in the print block. All active parameters entered as YES in the sublist will be transmitted during a block print. Parameters entered as NO will not be sent.

The "Print All" (Prnt ALL) option selects all meter values for transmitting (YES), without having to individually select each parameter in the sublist.

Note: Inactive parameters will not be sent regardless of the print option setting. For example, the Cycle Counter and Cycle Counter Start values will only be sent when the Cycle Counter is enabled. If disabled, these parameters are inactive and will not be transmitted. Likewise, the Setpoint parameters will not be sent unless an optional setpoint card is installed in the meter.

DISPLAY	DESCRIPTION	FACTORY SETTING	MNEMONIC
VALUE	Timer	YES	TMR
VALUE	Cycle Counter	NO	CNT
Start	Timer Start	NO	TST
STOP	Timer Stop	NO	TSP
Start	Counter Start	NO	CST
ON	Setpoint ON	NO	SPT
OFF	Setpoint OFF	NO	SOF
TIMEOUT	Setpoint Time-out	NO	STO

Sending Serial Commands and Data

When sending commands to the meter, a string containing at least one command character must be constructed. A command string consists of a command character, a value identifier, numerical data (if writing data to the meter) followed by a command terminator character, * or \$.

Command Chart

Command	Description	Notes
N	Node (meter) Address Specifier	Address a specific meter. Must be followed by one or two digit node address. Not required when node address = 0.
T	Transmit Value (read)	Read a register from the meter. Must be followed by a register ID character.
V	Value Change (write)	Write to register of the meter. Must be followed by a register ID character and numeric data.
R	Reset	Reset a value or the output. Must be followed by a register ID character
P	Block Print Request (read)	Initiates a block print output. Registers in the print block are selected in Print Options.

Command String Construction

The command string must be constructed in a specific sequence. The meter does not respond with an error message to illegal commands. The following procedure details construction of a command string:

1. The first 2 or 3 characters consist of the Node Address Specifier (N) followed by a 1 or 2 character node address number. The node address number of the meter is programmable. If the node address is 0, this command and the node address itself may be omitted. This is the only command that may be used in conjunction with other commands.
2. After the optional address specifier, the next character is the command character.
3. The next character is the register ID. This identifies the register that the command affects. The P command does not require a register ID character. It prints all the active selections chosen in the Print Options menu parameter.
4. If constructing a value change command (writing data), the numeric data is sent next.
5. All command strings must be terminated with the string termination characters * or \$. The meter does not begin processing the command string until this character is received. See timing diagram figure for differences in meter response time when using the * and \$ terminating characters.

Receiving Data From The Meter

Data is transmitted from the meter in response to either a transmit command (T), a block print request command (P) or a User Input print request. The response from the meter is either a full field transmission or an abbreviated transmission, depending on the selection chosen in Module 5.

Full Field Transmission

Byte	Description
1, 2	2 byte Node Address field [00-99]
3	<SP> (Space)
4-6	3 byte Register Mnemonic field
7-18	12 byte data field; 9 bytes for number and three bytes for decimal points
19	<CR> (carriage return)
20	<LF> (line feed)
21	<SP>* (Space)
22	<CR>* (carriage return)
23	<LF>* (line feed)

* These characters only appear in the last line of a block print.

The first two characters transmitted are the meter address. If the address assigned is 0, two spaces are substituted. A space follows the meter address field. The next three characters are the register mnemonic, as shown in the Register Identification Chart.

The numeric data is transmitted next. The numeric field (bytes 7 to 18) is 12 characters long. When a display overflow exists for a requested timer or cycle counter value, an * (used as an overflow character) replaces a space in byte 7. Byte 8 is always a space.

The remaining ten positions of this field consist of seven positions for the requested value with decimal points positioned for the selected timer range. The

Register Identification Chart

ID	Value Description	MNEMONIC	Applicable Commands	Transmit Details (T and V)
A	Timer	TMR	T, V, R	7 digit, per Timer Range
B	Cycle Counter	CNT	T, V, R	6 digit
C	Timer Start	TST	T, V	7 digit, per Timer Range
D	Timer Stop	TSP	T, V	7 digit, per Timer Range
E	Counter Start	CST	T, V	6 digit
F	Setpoint ON (Reset Output)	SPT	T, V, R	per Setpoint Assignment, same as Timer or Counter
G	Setpoint OFF	SOF	T, V	per Setpoint Assignment, same as Timer or Counter
H	Setpoint Time-out	STO	T, V	6 digit, mm.ss.ss format

Command String Examples:

1. Node address = 17, Write 350 to the Setpoint On value
String: N17VF350\$
2. Node address = 5, Read Timer value, response time of 50 msec min
String: N5TA*
3. Node address = 0, Reset Setpoint output
String: RF*
4. Node address = 31, Request a Block Print Output, response time of 2 msec min
String: N31P\$

Transmitting Data to the Meter

Numeric data sent to the meter must be limited to Transmit Details listed in the Register Identification Chart. Leading zeros are ignored. The meter ignores any decimal point and conforms the number to the appropriate display format. (For example: The Timer range is set for tenths of a second and 25 is written to the Timer Start register. The value of the register is now 2.5 seconds. In this case, write a value of 250 to equal 25.0 seconds).

Note: Since the meter does not issue a reply to value change commands, follow with a transmit value command for readback verification.

data within bytes 9 to 18 is right-aligned with leading spaces for any unfilled positions.

The end of the response string is terminated with a <CR> and <LF>. After the last line of a block print, an extra <SP>, <CR> and <LF> are added to provide separation between the print blocks.

Abbreviated Transmission

Byte	Description
1-12	12 byte data field, 9 bytes for number and three bytes for decimal points
13	<CR> (carriage return)
14	<LF> (line feed)
15	<SP>* (Space)
16	<CR>* (carriage return)
17	<LF>* (line feed)

* These characters only appear in the last line of a block print.

The abbreviated response suppresses the node address and register mnemonic, leaving only the numeric part of the response.

Meter Response Examples:

1. Node address = 17, full field response, Cycle Counter = 875
17 CNT 875 <CR><LF>
2. Node address = 0, full field response, Setpoint On value = 250.5
SPT 250.5<CR><LF>
3. Node address = 0, abbreviated response, Setpoint On value= 250, last line of block print
250<CR><LF><SP><CR><LF>

Command Response Time

The meter can only receive data or transmit data at any one time (half-duplex operation). During RS232 transmissions, the meter ignores commands while transmitting data, but instead uses RXD as a busy signal. When sending commands and data to the meter, a delay must be imposed before sending another command. This allows enough time for the meter to process the command and prepare for the next command.

At the start of the time interval t_1 , the computer program prints or writes the string to the com port, thus initiating a transmission. During t_1 , the command characters are under transmission and at the end of this period, the command terminating character (* or \$) is received by the meter. The time duration of t_1 is dependent on the number of characters and baud rate of the channel.

$$t_1 = (10 \text{ times the \# of characters}) / \text{baud rate}$$

At the start of time interval t_2 , the meter starts the interpretation of the command and when complete, performs the command function. This time interval t_2 varies. If no response from the meter is expected, the meter is ready to accept another command.

If the meter is to reply with data, the time interval t_2 is controlled by the use of the command terminating character. The '*' terminating character results in a response time of 50 msec. minimum. This allows sufficient time for the release of the sending driver on the RS485 bus. Terminating the command line with '\$' results in a response time (t_2) of 2 msec. minimum. The faster response time of this terminating character requires that sending drivers release within 2 msec. after the terminating character is received.

At the beginning of time interval t_3 , the meter responds with the first character of the reply. As with t_1 , the time duration of t_3 is dependent on the number of characters and baud rate of the channel. At the end of t_3 , the meter is ready to receive the next command.

$$t_3 = (10 \text{ times the \# of characters}) / \text{baud rate}$$

The maximum serial throughput of the meter is limited to the sum of the times t_1 , t_2 and t_3 .

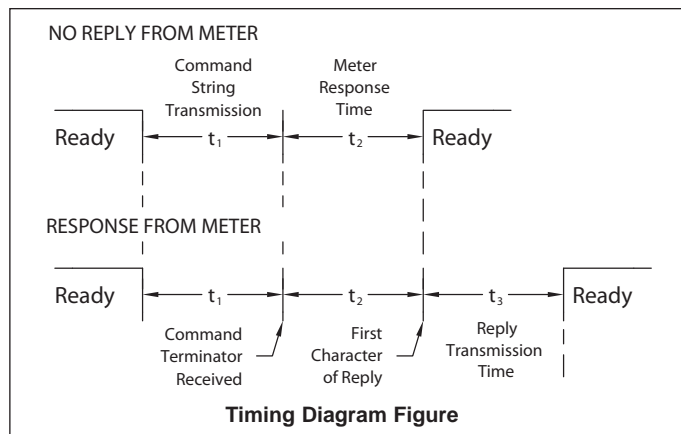

Communication Format

Data is transferred from the meter through a serial communication channel. In serial communications, the voltage is switched between a high and low level at a predetermined rate (baud rate) using ASCII encoding. The receiving device reads the voltage levels at the same intervals and then translates the switched levels back to a character. The voltage level conventions depend on the interface standard. The table lists the voltage levels for each standard.

LOGIC	INTERFACE STATE	RS232*	RS485*
1	mark (idle)	TXD,RXD; -3 to -15 V	a-b < -200 mV
0	space (active)	TXD,RXD; +3 to +15 V	a-b > +200 mV

* Voltage levels at the Receiver

Data is transmitted one byte at a time with a variable idle period between characters (0 to ∞). Each ASCII character is "framed" with a beginning start bit, an optional parity bit and one or more ending stop bits. The data format and baud rate must match that of other equipment in order for communication to take place. The figures list the data formats employed by the meter.

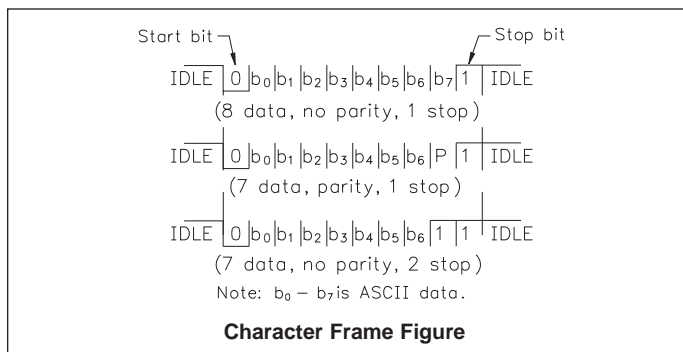

Start Bit and Data Bits

Data transmission always begins with the start bit. The start bit signals the receiving device to prepare for reception of data. One bit period later, the least significant bit of the ASCII encoded character is transmitted, followed by the remaining data bits. The receiving device then reads each bit position as they are transmitted.

Parity Bit

After the data bits, the parity bit is sent. The transmitter sets the parity bit to a zero or a one, so that the total number of ones contained in the transmission (including the parity bit) is either even or odd. This bit is used by the receiver to detect errors that may occur to an odd number of bits in the transmission. However, a single parity bit cannot detect errors that may occur to an even number of bits. Given this limitation, the parity bit is often ignored by the receiving device. The CUB5T meter ignores the parity bit of incoming data and sets the parity bit to odd, even or none (mark parity) for outgoing data.

Stop Bit

The last character transmitted is the stop bit. The stop bit provides a single bit period pause to allow the receiver to prepare to re-synchronize to the start of a new transmission (start bit of next byte). The receiver then continuously looks for the occurrence of the start bit. If 7 data bits and no parity is selected, then 2 stop bits are sent from the meter.

This page intentionally left blank.

CUB5T PROGRAMMING QUICK OVERVIEW

Press and hold **SEL** key to enter Programming Mode.

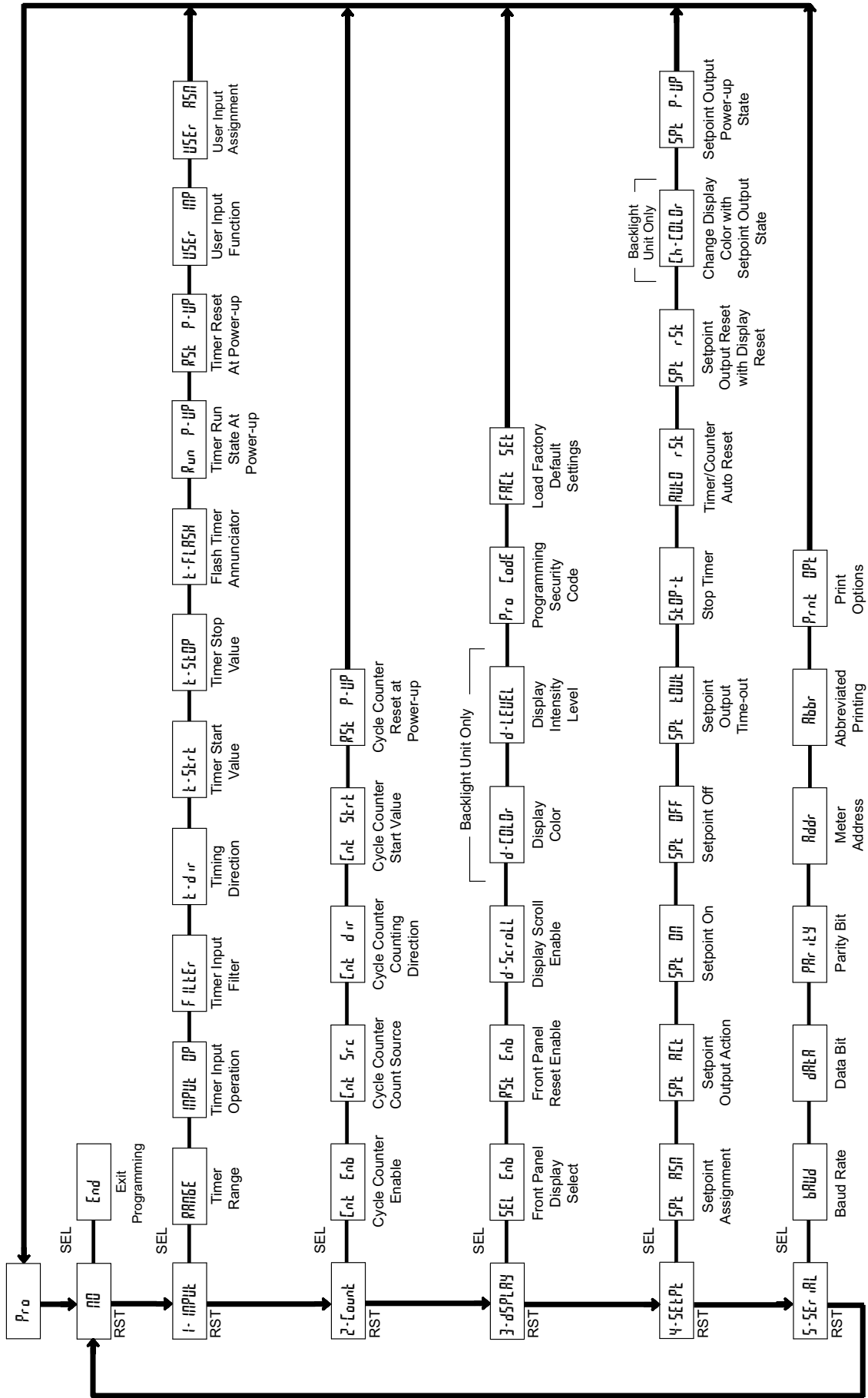

LIMITED WARRANTY

The Company warrants the products it manufactures against defects in materials and workmanship for a period limited to two years from the date of shipment, provided the products have been stored, handled, installed, and used under proper conditions. The Company's liability under this limited warranty shall extend only to the repair or replacement of a defective product, at The Company's option. The Company disclaims all liability for any affirmation, promise or representation with respect to the products.

The customer agrees to hold Red Lion Controls harmless from, defend, and indemnify RLC against damages, claims, and expenses arising out of subsequent sales of RLC products or products containing components manufactured by RLC and based upon personal injuries, deaths, property damage, lost profits, and other matters which Buyer, its employees, or sub-contractors are or may be to any extent liable, including without limitation penalties imposed by the Consumer Product Safety Act (P.L. 92-573) and liability imposed upon any person pursuant to the Magnuson-Moss Warranty Act (P.L. 93-637), as now in effect or as amended hereafter.

No warranties expressed or implied are created with respect to The Company's products except those expressly contained herein. The Customer acknowledges the disclaimers and limitations contained herein and relies on no other warranties or affirmations.

Red Lion Controls
Headquarters
20 Willow Springs Circle
York PA 17406
Tel +1 (717) 767-6511
Fax +1 (717) 764-0839

Red Lion Controls
Europe
Printerweg 10
NL - 3821 AD Amersfoort
Tel +31 (0) 334 723 225
Fax +31 (0) 334 893 793

Red Lion Controls
India
54, Vishvas Tenement
GST Road, New Ranip,
Ahmedabad-382480 Gujarat, India
Tel +91 987 954 0503
Fax +91 79 275 31 350

Red Lion Controls
China
Unit 101, XinAn Plaza
Building 13, No.99 Tianzhou Road
ShangHai, P.R. China 200223
Tel +86 21 6113-3688
Fax +86 21 6113-3683