

MCV 1,5/ 2-G-3,81 - PCB header



1803426

<https://www.phoenixcontact.com/us/products/1803426>

Please be informed that the data shown in this PDF document is generated from our online catalog. Please find the complete data in the user documentation. Our general terms of use for downloads are valid.



PCB headers, nominal cross section: 1.5 mm², color: green, nominal current: 8 A, rated voltage (III/2): 160 V, contact surface: Tin, contact connection type: Pin, number of potentials: 2, number of rows: 1, number of positions: 2, number of connections: 2, product range: MCV 1,5/..-G, pitch: 3.81 mm, mounting: Wave soldering, pin layout: Linear pinning, solder pin [P]: 3.4 mm, number of solder pins per potential: 1, plug-in system: COMBICON MC 1,5, Pin connector pattern alignment: Standard, locking: without, mounting: without, type of packaging: packed in cardboard

Your advantages

- Well-known mounting principle allows worldwide use
- Vertical connection enables multi-row arrangement on the PCB
- Maximum flexibility when it comes to device design – one header for connectors with different connection technologies

Commercial data

Item number	1803426
Packing unit	250 pc
Minimum order quantity	250 pc
Sales key	AA02
Product key	AABSBE
Catalog page	Page 226 (C-1-2013)
GTIN	4017918045739
Weight per piece (including packing)	0.646 g
Weight per piece (excluding packing)	0.589 g
Customs tariff number	85366930
Country of origin	DE

MCV 1,5/ 2-G-3,81 - PCB header



1803426

<https://www.phoenixcontact.com/us/products/1803426>

Technical data

Product properties

Product type	PCB headers
Product family	MCV 1,5/..-G
Product line	COMBICON Connectors S
Type	Standard
Number of positions	2
Pitch	3.81 mm
Number of connections	2
Number of rows	1
Number of potentials	2
Mounting flange	without
Pin layout	Linear pinning
Solder pins per potential	1

Electrical properties

Nominal current I_N	8 A
Nominal voltage U_N	160 V
Contact resistance	1.2 m Ω
Rated voltage (III/3)	160 V
Rated surge voltage (III/3)	2.5 kV
Rated voltage (III/2)	160 V
Rated surge voltage (III/2)	2.5 kV
Rated voltage (II/2)	250 V
Rated surge voltage (II/2)	2.5 kV

Mounting

Mounting type	Wave soldering
Pin layout	Linear pinning

Material specifications

Material data - contact

Note	WEEE/RoHS-compliant, free of whiskers according to IEC 60068-2-82/JEDEC JESD 201
Contact material	Cu alloy
Surface characteristics	Tin-plated
Metal surface contact area (top layer)	Tin (3 - 5 μm Sn)
Metal surface contact area (middle layer)	Nickel (1 - 3 μm Ni)
Metal surface soldering area (top layer)	Tin (3 - 5 μm Sn)
Metal surface soldering area (middle layer)	Nickel (1 - 3 μm Ni)

Material data - housing

Color (Housing)	green (6021)
-----------------	--------------

MCV 1,5/ 2-G-3,81 - PCB header

1803426

<https://www.phoenixcontact.com/us/products/1803426>

Insulating material	PBT
Insulating material group	IIIa
CTI according to IEC 60112	225
Flammability rating according to UL 94	V0

Dimensions

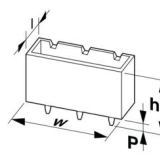
Dimensional drawing	
Pitch	3.81 mm
Width [w]	9.01 mm
Height [h]	12.6 mm
Length [l]	7.25 mm
Installed height	9.2 mm
Solder pin length [P]	3.4 mm
Pin dimensions	0.8 x 0.8 mm

PCB design

Hole diameter	1.2 mm
---------------	--------

Mechanical tests

Visual inspection

Specification	IEC 60512-1-1:2002-02
Result	Test passed

Dimension check

Specification	IEC 60512-1-2:2002-02
Result	Test passed

Resistance of inscriptions

Specification	IEC 60068-2-70:1995-12
Result	Test passed

Polarization and coding

Specification	IEC 60512-13-5:2006-02
Result	Test passed

Contact holder in insert

Specification	IEC 60512-15-1:2008-05
Contact holder in insert Requirements >20 N	Test passed

Insertion and withdrawal forces

Result	Test passed
--------	-------------

MCV 1,5/ 2-G-3,81 - PCB header



1803426

<https://www.phoenixcontact.com/us/products/1803426>

No. of cycles	25
Insertion strength per pos. approx.	8 N
Withdraw strength per pos. approx.	6 N

Electrical tests

Thermal test | Test group C

Specification	IEC 60512-5-1:2002-02
Tested number of positions	20

Insulation resistance

Specification	IEC 60512-3-1:2002-02
Insulation resistance, neighboring positions	> 5 MΩ

Air clearances and creepage distances |

Specification	IEC 60664-1:2007-04
Insulating material group	IIIa
Comparative tracking index (IEC 60112)	CTI 225
Rated insulation voltage (III/3)	160 V
Rated surge voltage (III/3)	2.5 kV
minimum clearance value - non-homogenous field (III/3)	1.5 mm
minimum creepage distance (III/3)	2.5 mm
Rated insulation voltage (III/2)	160 V
Rated surge voltage (III/2)	2.5 kV
minimum clearance value - non-homogenous field (III/2)	1.5 mm
minimum creepage distance (III/2)	1.6 mm
Rated insulation voltage (II/2)	250 V
Rated surge voltage (II/2)	2.5 kV
minimum clearance value - non-homogenous field (II/2)	1.5 mm
minimum creepage distance (II/2)	2.5 mm

Environmental and real-life conditions

Vibration test

Specification	IEC 60068-2-6:2007-12
Frequency	10 - 150 - 10 Hz
Sweep speed	1 octave/min
Amplitude	0.35 mm (10 Hz ... 60.1 Hz)
Acceleration	5g (60.1 Hz ... 150 Hz)
Test duration per axis	2.5 h

Durability test

Specification	IEC 60512-9-1:2010-03
Impulse withstand voltage at sea level	2.95 kV
Contact resistance R ₁	1.2 mΩ
Contact resistance R ₂	1.2 mΩ

MCV 1,5/ 2-G-3,81 - PCB header



1803426

<https://www.phoenixcontact.com/us/products/1803426>

Insertion/withdrawal cycles	25
Insulation resistance, neighboring positions	> 5 MΩ

Climatic test

Specification	ISO 6988:1985-02
Corrosive stress	0.2 dm ³ SO ₂ on 300 dm ³ /40 °C/1 cycle
Thermal stress	100 °C/168 h
Power-frequency withstand voltage	1.39 kV

Ambient conditions

Ambient temperature (operation)	-40 °C ... 100 °C (dependent on the derating curve)
Ambient temperature (storage/transport)	-40 °C ... 70 °C
Relative humidity (storage/transport)	30 % ... 70 %
Ambient temperature (assembly)	-5 °C ... 100 °C

Packaging specifications

Type of packaging	packed in cardboard
-------------------	---------------------

MCV 1,5/ 2-G-3,81 - PCB header

1803426

<https://www.phoenixcontact.com/us/products/1803426>

Drawings

Diagram

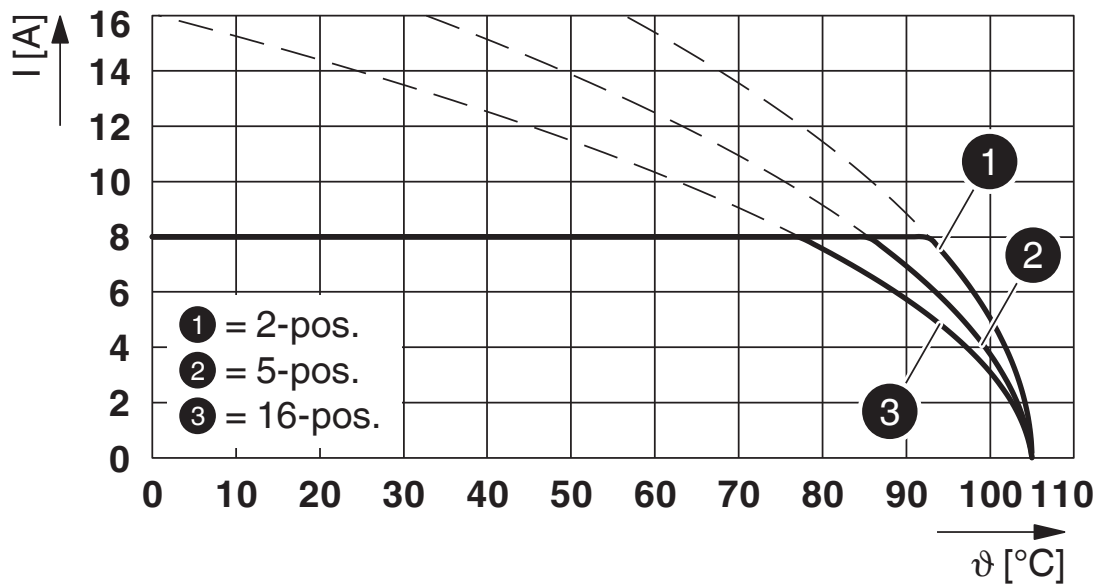

Type: LPC 1,5/...-ST-3,81 with MCV 1,5/...-G-3,81

Dimensional drawing

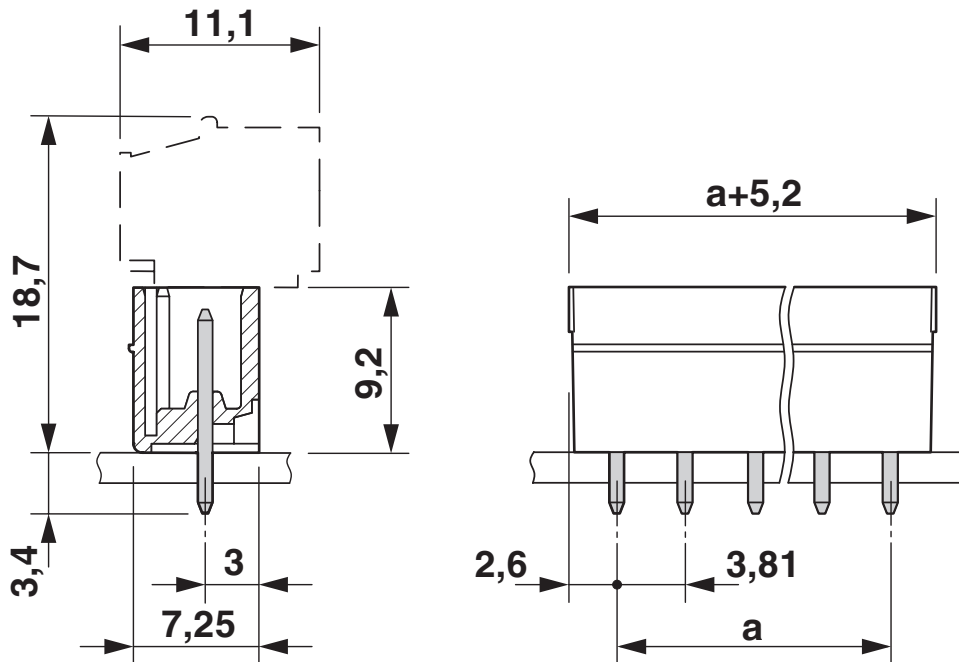

MCV 1,5/ 2-G-3,81 - PCB header

1803426

<https://www.phoenixcontact.com/us/products/1803426>

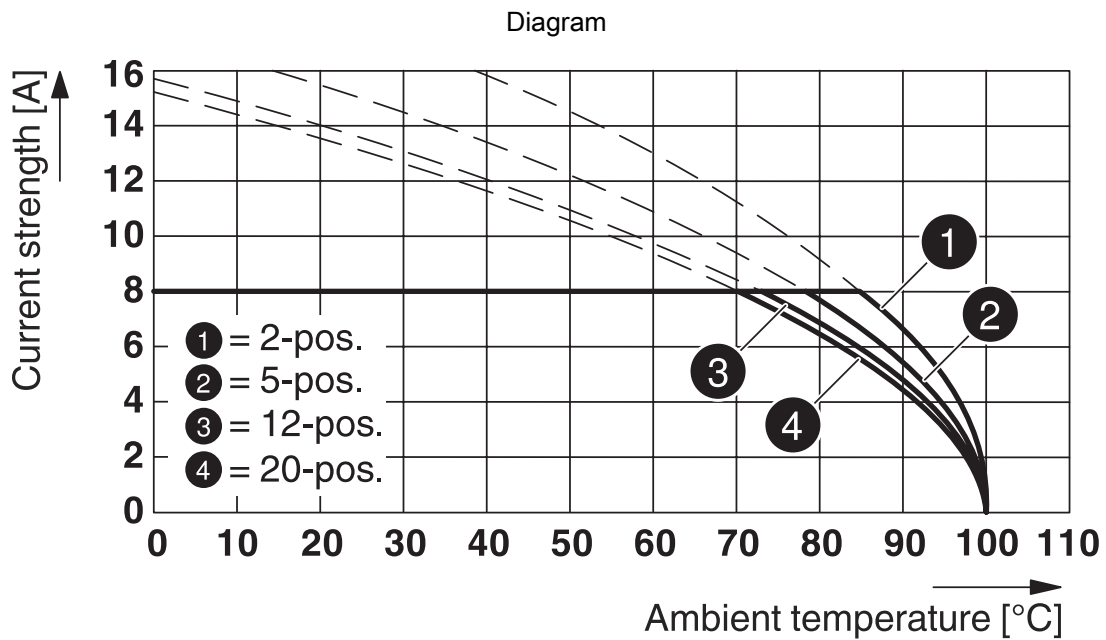

Type: FMC 1,5/...-ST-3,81 with MCV 1,5/...-G-3,81

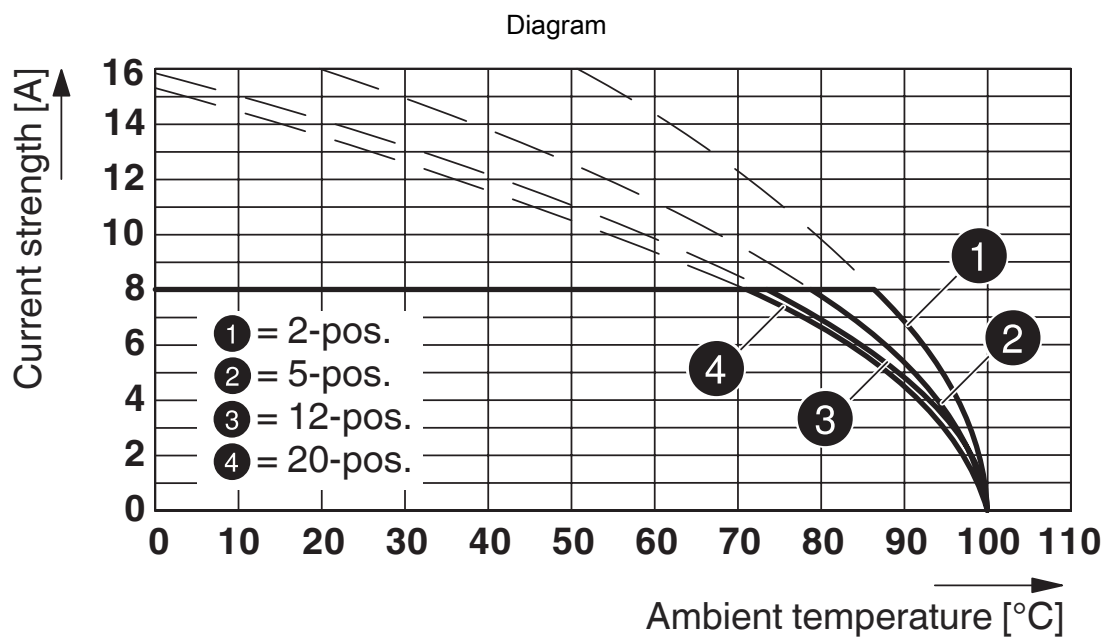

Type: FRONT-MC 1,5/...-ST-3,81 with MCV 1,5/...-G-3,81

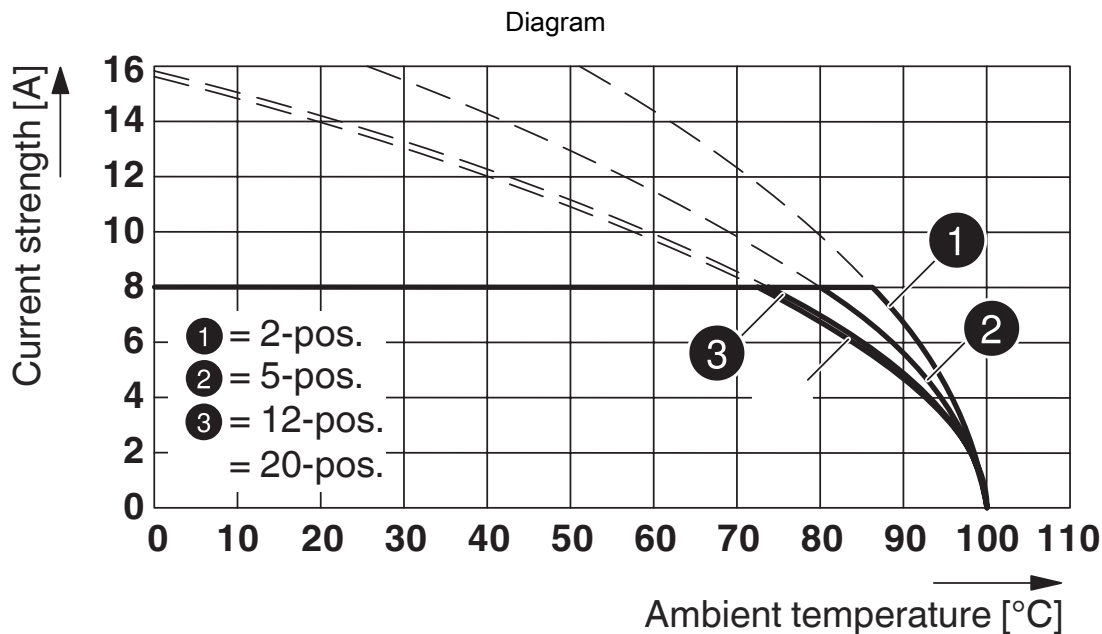

Type: FK-MCP 1,5/...-ST-3,81 with MCV 1,5/...-G-3,81

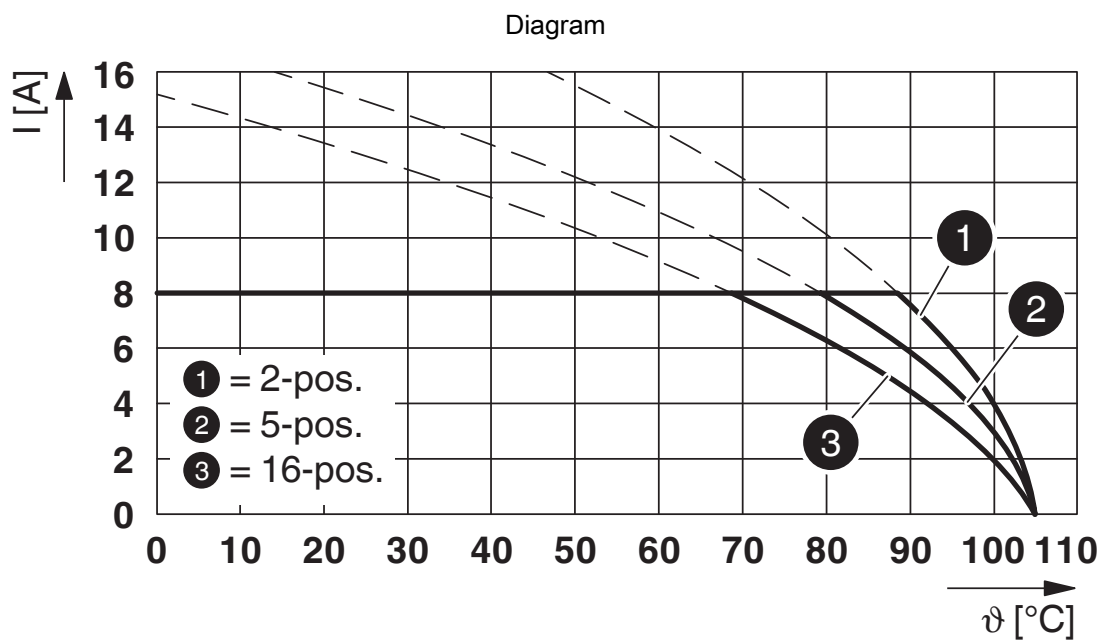

Type: IMC 1,5/...-G-3,81 with MCV 1,5/...-G-3,81

MCV 1,5/ 2-G-3,81 - PCB header

1803426

<https://www.phoenixcontact.com/us/products/1803426>

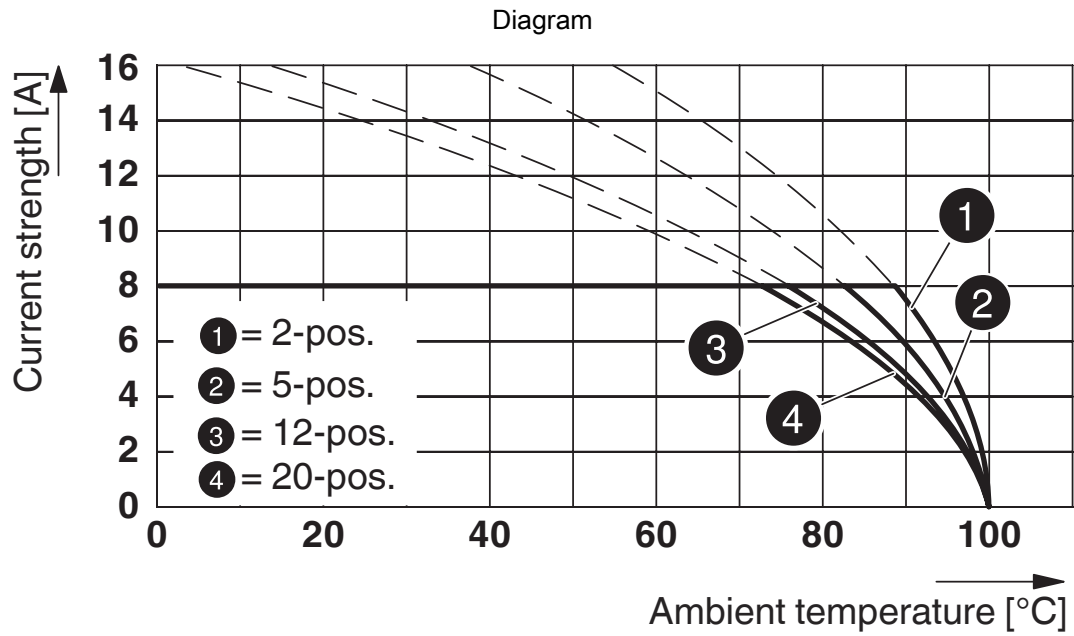

Type: MC 1,5/...-ST-3,81 with MCV 1,5/...-G-3,81

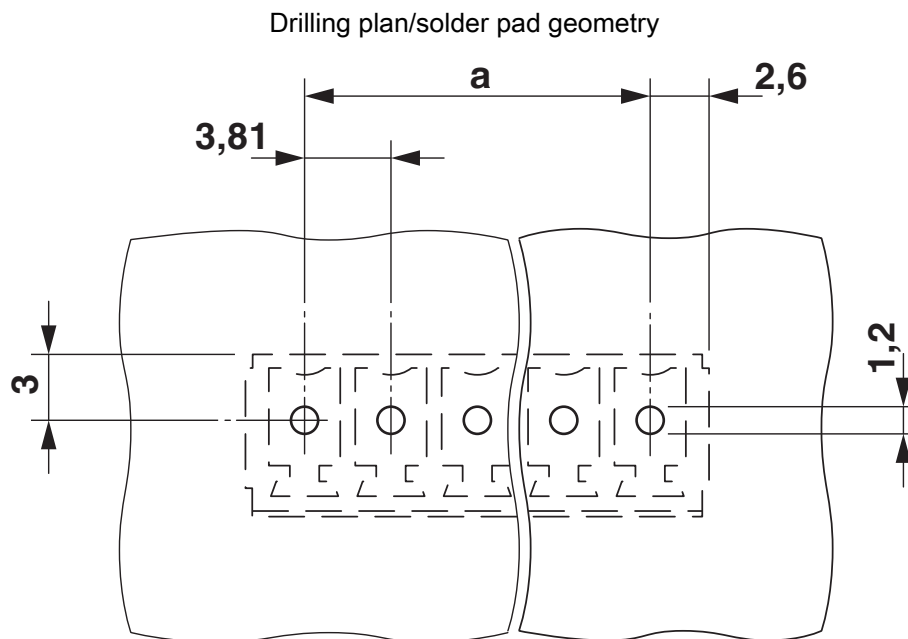

MCV 1,5/ 2-G-3,81 - PCB header





1803426

<https://www.phoenixcontact.com/us/products/1803426>

Approvals

To download certificates, visit the product detail page: <https://www.phoenixcontact.com/us/products/1803426>

 CSA Approval ID: 13631				
	Nominal voltage U_N	Nominal current I_N	Cross section AWG	Cross section mm^2
Use group B	300 V	8 A	-	-
Use group D	300 V	8 A	-	-

 cULus Recognized Approval ID: E60425-20110128				
	Nominal voltage U_N	Nominal current I_N	Cross section AWG	Cross section mm^2
Use group B	300 V	8 A	-	-
Use group D	300 V	8 A	-	-

 VDE Zeichengenehmigung Approval ID: 40011723				
	Nominal voltage U_N	Nominal current I_N	Cross section AWG	Cross section mm^2
	160 V	8 A	-	-

MCV 1,5/ 2-G-3,81 - PCB header



1803426

<https://www.phoenixcontact.com/us/products/1803426>

Classifications

ECLASS

ECLASS-11.0	27460201
ECLASS-12.0	27460201
ECLASS-13.0	27460201

ETIM

ETIM 9.0	EC002637
----------	----------

UNSPSC

UNSPSC 21.0	39121400
-------------	----------

MCV 1,5/ 2-G-3,81 - PCB header



1803426

<https://www.phoenixcontact.com/us/products/1803426>

Environmental product compliance

EU RoHS

Fulfills EU RoHS substance requirements	Yes, No exemptions
---	--------------------

China RoHS

Environment friendly use period (EFUP)	EFUP-E
	No hazardous substances above the limits

EU REACH SVHC

REACH candidate substance (CAS No.)	No substance above 0.1 wt%
-------------------------------------	----------------------------

MCV 1,5/ 2-G-3,81 - PCB header

1803426

<https://www.phoenixcontact.com/us/products/1803426>



Accessories

SK 3,81/2,8:FORTL.ZAHLEN - Marker card

0804109

<https://www.phoenixcontact.com/us/products/0804109>



Marker card, Sheet, white, labeled, horizontal: consecutive numbers 1 ... 10, 11 .. 20, etc. up to 91 ... (99)100, mounting type: adhesive, for terminal block width: 3.81 mm, lettering field size: 3.81 x 2.8 mm, Number of individual labels: 14

CP-MSTB - Coding profile

1734634

<https://www.phoenixcontact.com/us/products/1734634>



Coding profile, is inserted into the slot on the plug or inverted header, red insulating material

MCV 1,5/ 2-G-3,81 - PCB header

1803426

<https://www.phoenixcontact.com/us/products/1803426>



B-STIFT - Marker pen

1051993

<https://www.phoenixcontact.com/us/products/1051993>



Marker pen, for manual labeling of unprinted Zack strips, smear-proof and waterproof, line thickness 0.5 mm

FMC 1,5/ 2-ST-3,81 - PCB connectors

1745894

<https://www.phoenixcontact.com/us/products/1745894>

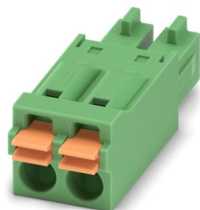

PCB connector, nominal cross section: 1.5 mm², color: green, nominal current: 8 A, rated voltage (III/2): 160 V, contact surface: Tin, contact connection type: Socket, number of potentials: 2, number of rows: 1, number of positions: 2, number of connections: 2, product range: FMC 1,5/..-ST, pitch: 3.81 mm, connection method: Push-in spring connection, conductor/PCB connection direction: 0 °, plug-in system: COMBICON MC 1,5, locking: without, mounting: without, type of packaging: packed in cardboard

MCV 1,5/ 2-G-3,81 - PCB header

1803426

<https://www.phoenixcontact.com/us/products/1803426>

MC 1,5/ 2-ST-3,81 - PCB connector

1803578

<https://www.phoenixcontact.com/us/products/1803578>



PCB connector, nominal cross section: 1.5 mm², color: green, nominal current: 8 A, rated voltage (III/2): 160 V, contact surface: Tin, contact connection type: Socket, number of potentials: 2, number of rows: 1, number of positions: 2, number of connections: 2, product range: MC 1,5/..-ST, pitch: 3.81 mm, connection method: Screw connection with tension sleeve, screw head form: L Slotted, conductor/PCB connection direction: 0 °, plug-in system: COMBICON MC 1,5, locking: without, mounting: without, type of packaging: packed in cardboard

MCVW 1,5/ 2-ST-3,81 - PCB connector

1826979

<https://www.phoenixcontact.com/us/products/1826979>



PCB connector, nominal cross section: 1.5 mm², color: green, nominal current: 8 A, rated voltage (III/2): 160 V, contact surface: Tin, contact connection type: Socket, number of potentials: 2, number of rows: 1, number of positions: 2, number of connections: 2, product range: MCVW 1,5/..-ST, pitch: 3.81 mm, connection method: Screw connection with tension sleeve, screw head form: L Slotted, conductor/PCB connection direction: -90 °, plug-in system: COMBICON MC 1,5, locking: without, mounting: without, type of packaging: packed in cardboard

MCV 1,5/ 2-G-3,81 - PCB header

1803426

<https://www.phoenixcontact.com/us/products/1803426>



MCVR 1,5/ 2-ST-3,81 - PCB connector

1827127

<https://www.phoenixcontact.com/us/products/1827127>



PCB connector, nominal cross section: 1.5 mm², color: green, nominal current: 8 A, rated voltage (III/2): 160 V, contact surface: Tin, contact connection type: Socket, number of potentials: 2, number of rows: 1, number of positions: 2, number of connections: 2, product range: MCVR 1,5/...-ST, pitch: 3.81 mm, connection method: Screw connection with tension sleeve, screw head form: L Slotted, conductor/PCB connection direction: 90 °, plug-in system: COMBICON MC 1,5, locking: without, mounting: without, type of packaging: packed in cardboard

FRONT-MC 1,5/ 2-ST-3,81 - PCB connectors

1850660

<https://www.phoenixcontact.com/us/products/1850660>



PCB connector, nominal cross section: 1.5 mm², color: green, nominal current: 8 A, rated voltage (III/2): 160 V, contact surface: Tin, contact connection type: Socket, number of potentials: 2, number of rows: 1, number of positions: 2, number of connections: 2, product range: FRONT-MC 1,5/...-ST, pitch: 3.81 mm, connection method: Front screw connection, screw head form: L Slotted, conductor/PCB connection direction: 0 °, plug-in system: COMBICON MC 1,5, locking: without, mounting: without, type of packaging: packed in cardboard

MCV 1,5/ 2-G-3,81 - PCB header

1803426

<https://www.phoenixcontact.com/us/products/1803426>



FK-MCP 1,5/ 2-ST-3,81 - PCB connector

1851041

<https://www.phoenixcontact.com/us/products/1851041>



PCB connector, nominal cross section: 1.5 mm², color: green, nominal current: 8 A, rated voltage (III/2): 160 V, contact surface: Tin, contact connection type: Socket, number of potentials: 2, number of rows: 1, number of positions: 2, number of connections: 2, product range: FK-MCP 1,5/...-ST, pitch: 3.81 mm, connection method: Push-in spring connection, conductor/PCB connection direction: 0 °, plug-in system: COMBICON MC 1,5, locking: without, mounting: without, type of packaging: packed in cardboard

MCC 1/ 2-STZ-3,81 - PCB connector

1852176

<https://www.phoenixcontact.com/us/products/1852176>

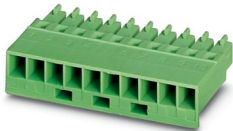

PCB connector, nominal cross section: 1 mm², color: green, nominal current: 8 A, rated voltage (III/2): 160 V, contact connection type: Socket, number of potentials: 2, number of rows: 1, number of positions: 2, number of connections: 2, product range: MCC 1/...-STZ, pitch: 3.81 mm, connection method: Crimp connection, conductor/PCB connection direction: 0 °, plug-in system: COMBICON MC 1,5, locking: without, mounting: without, type of packaging: packed in cardboard, Corresponding female crimp contacts with current [A] and conductor cross section range [mm²] data: 5A/MCC-MT 0,2-0,35 (1859988); 8A/MCC-MT 0,5-1,0 (1859991)

MCV 1,5/ 2-G-3,81 - PCB header

1803426

<https://www.phoenixcontact.com/us/products/1803426>



QC 0,5/ 2-ST-3,81 - PCB connectors

1897393

<https://www.phoenixcontact.com/us/products/1897393>

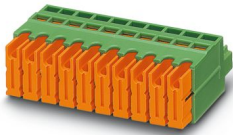

PCB connector, nominal cross section: 0.5 mm², color: green, nominal current: 6 A, rated voltage (III/2): 200 V, contact surface: Tin, contact connection type: Socket, number of potentials: 2, number of rows: 1, number of positions: 2, number of connections: 2, product range: QC 0,5/...-ST, pitch: 3.81 mm, connection method: Displacement connection, conductor/PCB connection direction: 0 °, plug-in system: COMBICON MC 1,5, locking: without, mounting: without, type of packaging: packed in cardboard

Phoenix Contact 2024 © - all rights reserved

<https://www.phoenixcontact.com>

Phoenix Contact USA
586 Fulling Mill Road
Middletown, PA 17057, United States
(+717) 944-1300
info@phoenixcon.com