



# SLIM8 A/Z

## SMALL, ALUMINIUM, SURFACE PROFILE

### MAŁY, ALUMINIOWY PROFIL NAWIERZCHNIOWY



- decorative lighting profile
- universal application
- Slick socket
- 2 channels for mounting bracket (with or without wall distance)
- painted holders
- maximum LED strip width: 8 mm
- profil dekoracyjno-oświetleniowy
- uniwersalne zastosowanie
- gniazdo Slick
- 2 rowki - 2 poziomy przymocowania uchwyty (z dystansem od ściany lub bez)
- malowane uchwyty
- maksymalna szerokość taśmy LED: 8 mm

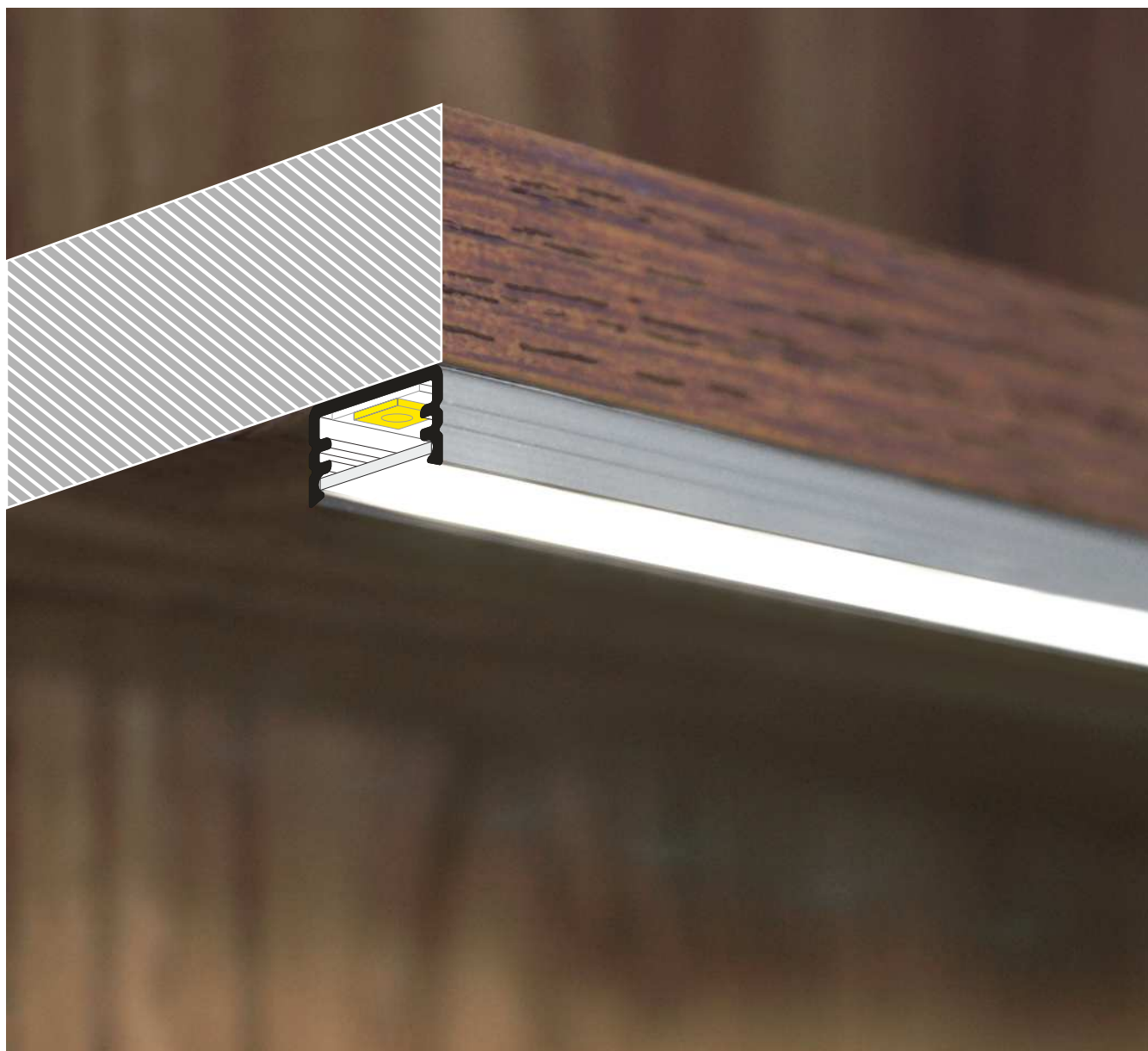

## SIMILAR IN THE OFFER / PODOBNE W OFERCIE



SMART10  
A/Z



SURFACE10  
BC/UX



BEGTON12  
J/S



SURFACE14  
EF/TY



# SLIM8 A/Z

- A** slide cover  
klosz A wsuwany
- Z**<sup>1</sup> Z flexible mounting plate  
uchwyt Z sprężysty
- Z**<sup>2</sup> cone Z flexible mounting plate  
uchwyt Z sprężysty cone

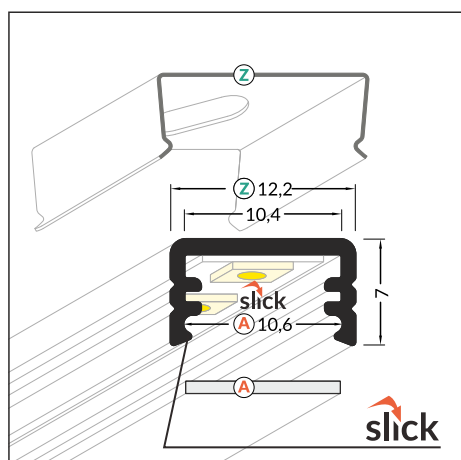
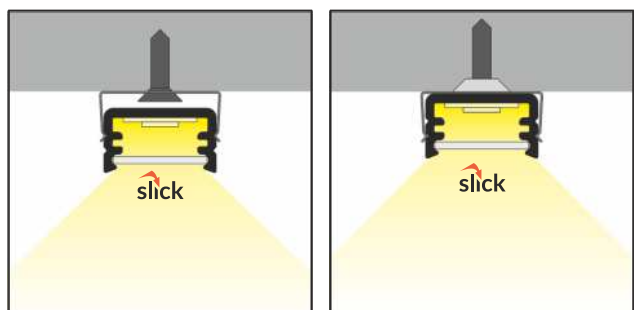
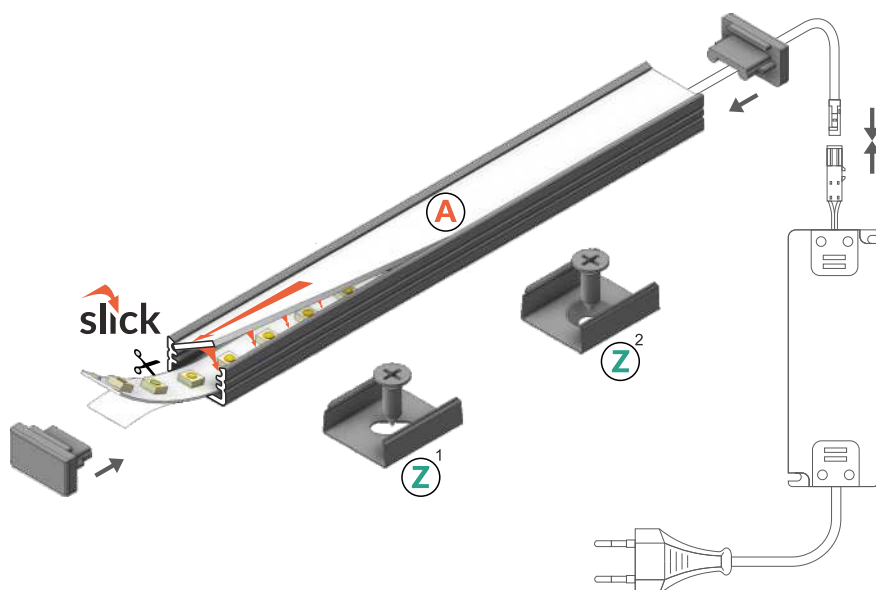

max 8 mm



surface  
nawierzchniowy



white painted  
biały malowany  
89030001



anodized  
anodowany  
89030020



black anodized  
czarny anodowany  
89030021



raw aluminium  
surowe aluminium  
89030000

INDEX = 1 pc, length 2000 mm  
package = 10 pcs  
INDEKS = 1 szt., długość 2000 mm  
opakowanie = 10 szt.

Available lengths / Dostępne długości  
1000 mm, 2000 mm, 3000 mm, 4000 mm



## COVERS / KLOSZE

**A slide cover**  
colours: transparent, frosted, white  
material: PC, PP, PP

klosz **A** wsuwany  
kolory: transparentny, szron, mleczny  
materiał: PC, PP, PP

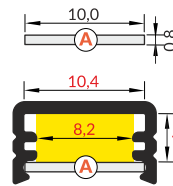

**Note!** Dimensions of the space to install LED source  
**Uwaga!** Wymiary przestrzeni do zamontowania źródła LED



INDEX = 1 pc, length 2000 mm  
package = 10 pcs  
INDEKS = 1 szt., długość 2000 mm  
opakowanie = 10 szt.

**A transparent / A transparentny**  
89070016

**A frosted / A szron**  
89070039

**A white / A mleczny**  
89070038

## ENDINGS / ZAŚLEPKI

**SLIM8 ending**  
colours: white, silver, black, grey  
material: ABS

zaślepka SLIM8  
kolory: biały, srebrny, czarny, szary  
materiał: ABS

**SLIM8 ending with hole**  
colours: white, silver, black, grey  
material: ABS

zaślepka SLIM8 z otworem  
kolory: biały, srebrny, czarny, szary  
materiał: ABS

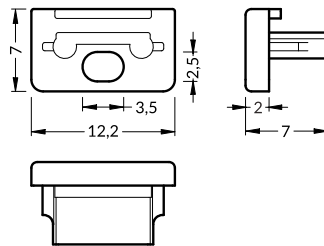

INDEX = 1 set  
package of 10 sets = 20 pcs  
INDEKS = 1 komplet, opakowanie zawiera 10 kompletów = 20 szt.

**white / białe**

with hole z otworem	without hole bez otworu
89960001	89040001

**silver / srebrne**

with hole z otworem	without hole bez otworu
89960040	89040040

**black / czarne**

with hole z otworem	without hole bez otworu
89960002	89040002

**grey / szare**

with hole z otworem	without hole bez otworu
89960022	89040022

## MOUNTINGS / MOCOWANIA

**Z flexible mounting plate**  
colours: white, inox, black  
material: stainless steel

uchwyt **Z** sprężysty  
kolory: biały, inox, czarny  
materiał: stal nierdzewna

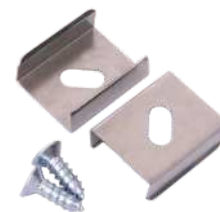
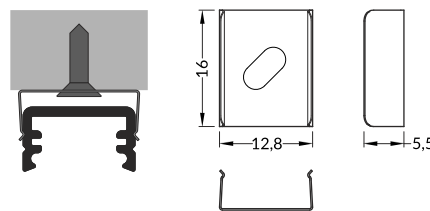

INDEX = 1 set  
package of 10 sets = 20 pcs  
INDEKS = 1 komplet, opakowanie zawiera 10 kpl = 20 szt.

**Z flexible mounting plate**  
uchwyt **Z** sprężysty

**white biały** 89270001

**inox inox** 89270019

**black czarny** 89270002

**cone Z flexible mounting plate**  
colours: white, inox, black  
material: stainless steel

uchwyt **Z** sprężysty cone  
kolory: biały, inox, czarny  
materiał: stal nierdzewna

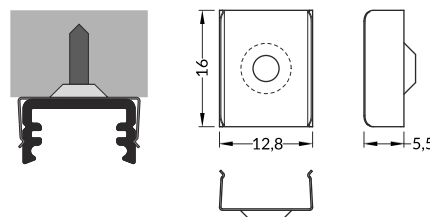

**cone Z flexible mounting plate**  
uchwyt **Z** sprężysty cone

**white biały** 89980001

**inox inox** 89980019

**black czarny** 89980002

**SLIM8 simple holder**  
material: zinc coated steel

uchwyt SLIM8 prosty  
materiał: stal ocynkowana

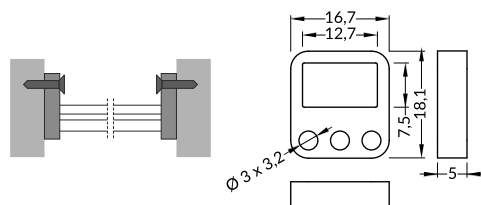

INDEX = 1 set = 2 pcs  
INDEKS = 1 komplet = 2 szt.

**simple holder**  
uchwyt prosty

**zinc coated**  
stal ocynkowana  
89110030





## CONNECTORS / ŁĄCZNIKI

**SLIM8 L connector**  
colours: white, anodized, black  
material: aluminium

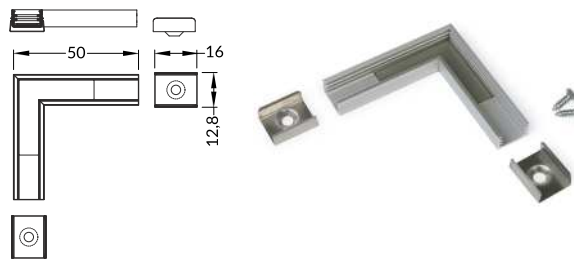
łącznik L SLIM8  
kolory: biały, anodowany, czarny  
materiał: aluminium



INDEX = 1 set  
INDEKS = 1 komplet

-  white painted  
biały malowany  
89150001
-  anodized  
anodowany  
89150020
-  black anodized  
czarny anodowany  
89150021



Made in Poland  
Wyprodukowane w Polsce



EU-registered industrial design  
Wzory przemysłowe EU

TOPMET LIGHT Kłósowicz Wiśniewski i Wspólnik Sp. j. ADDRESS: Ostrowska 354, 61-312 Poznań, POLAND  
tel. +48 61 87 27 500, fax. +48 61 87 27 518 biuro@topmet.pl, www.topmet.pl

The catalogue is not an offer under Polish Civil Code regulations. Colours of particular products may vary slightly from colours shown in pictures. The dimensions given are approximate and can not be a reason for complaint. TOPMET Company reserves the right to make technical changes.  
Folder nie stanowi oferty w myśl przepisów Kodeksu Cywilnego. Aktualną ofertę firmy stanowi cennik. Kolory poszczególnych produktów mogą się nieznacznie różnić od kolorów prezentowanych na zdjęciach. Podane wymiary są wymiarami orientacyjnymi i nie mogą stanowić podstawy reklamacji. Firma TOPMET zastrzega sobie prawo do wprowadzania zmian technicznych.

brochure designer • proj. folderu: M. Kędziora, A. Szafran 11.2016. photo • fot. K. Samulska, A. Szafran, L. Wesolowski