

### Product Summary

$V_{RRM}$	1200 V
$I_F (T_C=155^\circ\text{C})$	30 A**
$Q_C$	178 nC**

### Features

- Extremely low reverse current
- No reverse recovery current
- Temperature independent switching
- Positive temperature coefficient on  $V_F$
- Excellent surge current capability
- Low capacitive charge

### Benefits

- Essentially no switching losses
- System efficiency improvement over Si diodes
- Increased power density
- Enabling higher switching frequency
- Reduction of heat sink requirements
- System cost savings due to smaller magnetics
- Reduced EMI

### Applications

- Switch mode power supplies (SMPS)
- Uninterruptible power supplies
- Motor drivers
- Power factor correction

### Package Pin Definitions

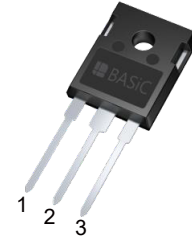
- Pin1 - Anode
- Pin2 and backside - Cathode
- Pin3 - Anode

### Package Parameters

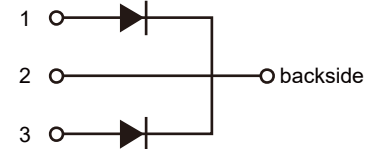
Part Number	Marking	Package
B2D30120HC1	B2D30120HC1	TO-247-3

\* Per Leg, \*\* Per Device

### Package: TO-247-3



### Electrical Connection



**Maximum Ratings ( $T_c=25^\circ\text{C}$  unless otherwise specified)**

Symbol	Parameter	Test conditions	Value	Unit
$V_{RRM}$	Repetitive peak reverse voltage		1200	V
$V_{RSM}$	Non-repetitive peak reverse voltage		1200	V
$I_F$	Continuous forward current	$T_c=25^\circ\text{C}$ $T_c=155^\circ\text{C}$	54*/108** 15*/30**	A
$I_{FSM}$	Non-repetitive forward surge current	$T_c=25^\circ\text{C}$ , $t_p=10\text{ms}$ Half sine wave	135*	A
$\int i^2 dt$	$i^2t$ value	$T_c=25^\circ\text{C}$ , $t_p=10\text{ms}$	91*	A <sup>2</sup> S
$P_{tot}$	Power dissipation	$T_c=25^\circ\text{C}$ $T_c=110^\circ\text{C}$	220* 95*	W
$T_j$	Operating junction temperature		-55~175	$^\circ\text{C}$
$T_{stg}$	Storage temperature		-55~175	$^\circ\text{C}$
	TO-247 mounting torque	M3 Screw	0.7	Nm

\* Per Leg, \*\* Per Device

**Thermal Characteristics**

Symbol	Parameter	Value			Unit
		Min.	Typ.	Max.	
$R_{th(jc)}$	Thermal resistance from junction to case		0.68*/ 0.34**		K/W

\* Per Leg, \*\* Per Device

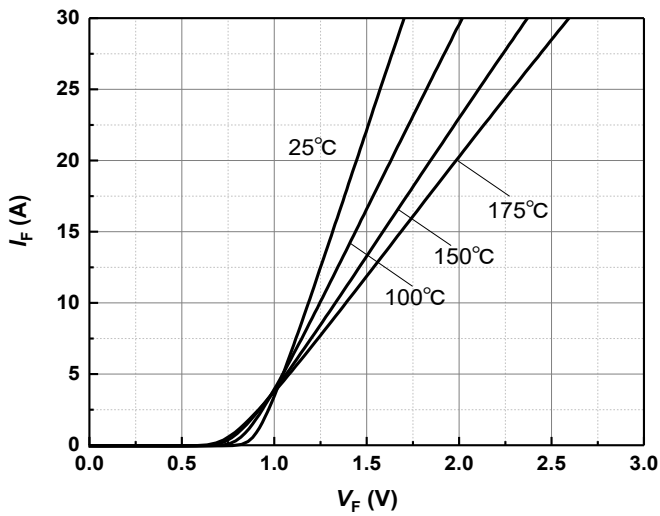
**Electrical Characteristics (Per Leg)**  
**Static Characteristics**

Symbol	Parameter	Test conditions	Value			Unit
			Min.	Typ.	Max.	
$V_{DC}$	DC blocking voltage	$T_J=25^{\circ}C$	1200			V
$V_F$	Diode forward voltage	$I_F=15A$ $T_J=25^{\circ}C$ $I_F=15A$ $T_J=175^{\circ}C$		1.35 1.75	1.6 2.4	V
$I_R$	Reverse current	$V_R=1200V$ $T_J=25^{\circ}C$ $V_R=1200V$ $T_J=175^{\circ}C$		10 40	120 400	$\mu A$

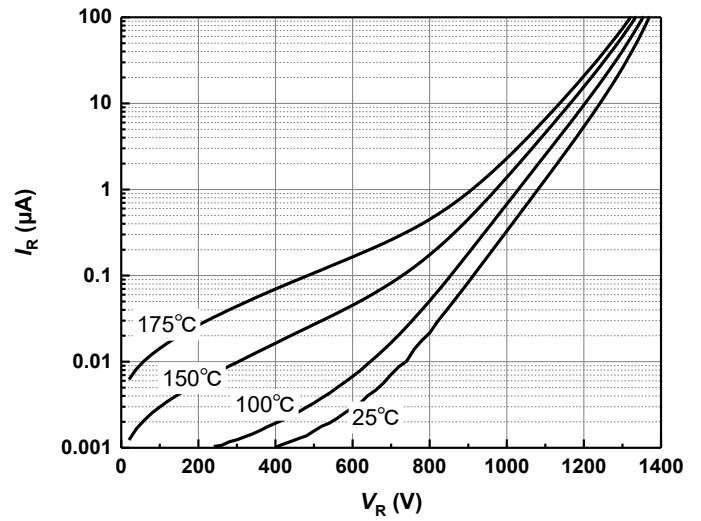
**AC Characteristics**

Symbol	Parameter	Test conditions	Value			Unit
			Min.	Typ.	Max.	
$Q_C$	Total capacitive charge	$V_R=800V$ $T_J=25^{\circ}C$ $Q_C=\int_0^{V_R} C(V)dV$		89		nC
$C$	Total capacitance	$V_R=1V$ $f=1MHz$ $V_R=400V$ $f=1MHz$ $V_R=800V$ $f=1MHz$		965 80 59		pF
$E_C$	Capacitance stored energy	$V_R=800V$		45		$\mu J$

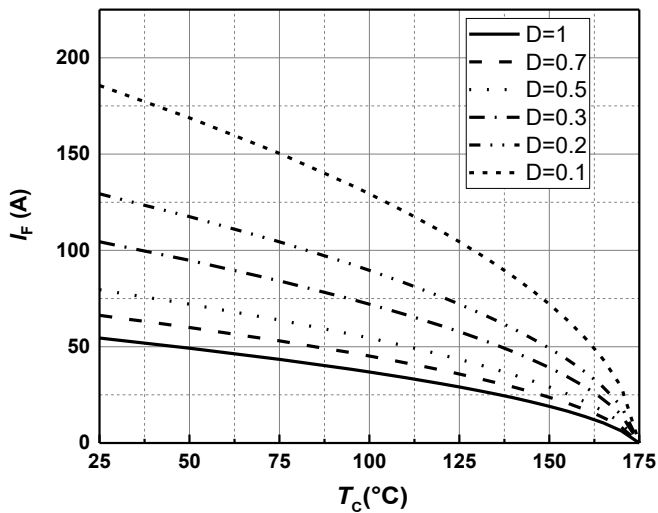
**Typical Performance (Per Leg)**



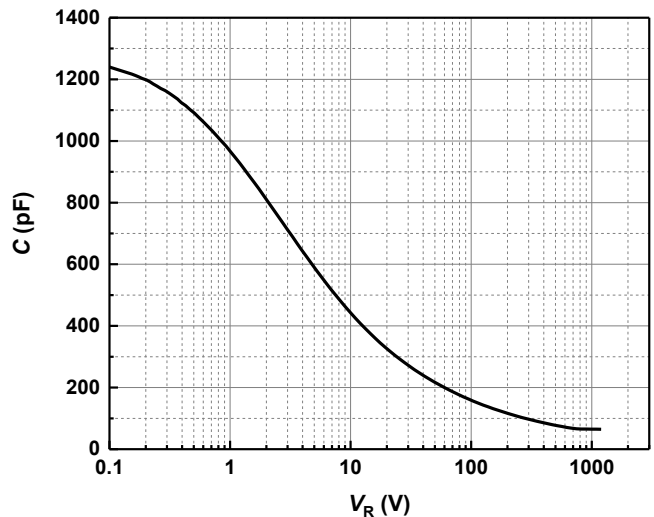
**Figure 1** Typical forward characteristics



**Figure 2** Typical reverse current as function of reverse voltage

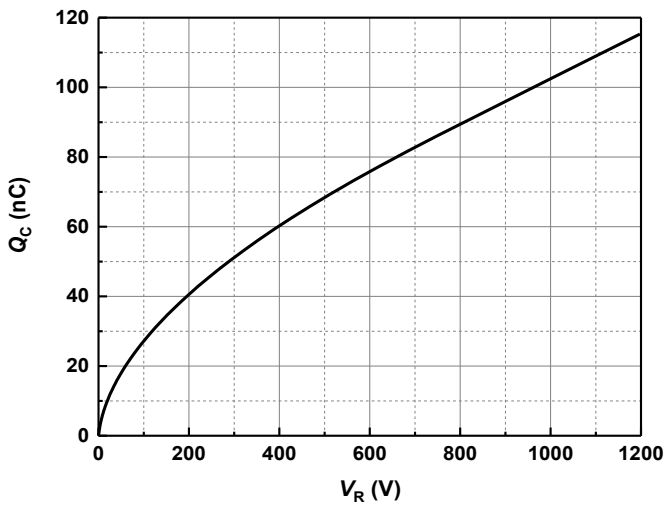


**Figure 3** Diode forward current as function of temperature, D=duty cycle

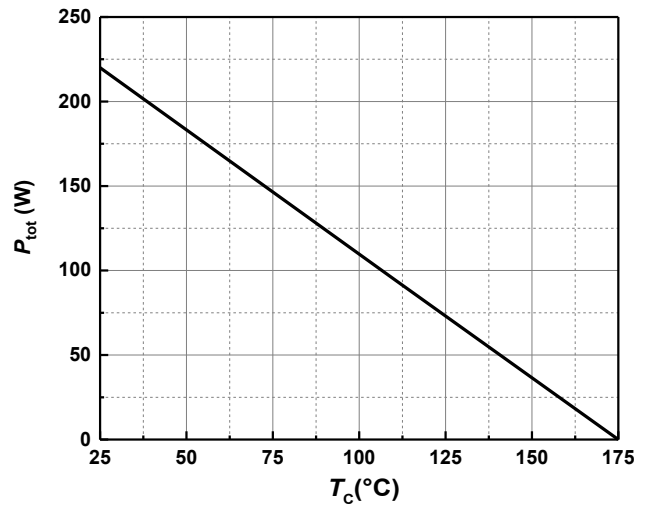


**Figure 4** Typical capacitance as function of reverse voltage,  $C=f(V_R)$ ;  $T_j=25^{\circ}$ C;  $f=1$  MHz

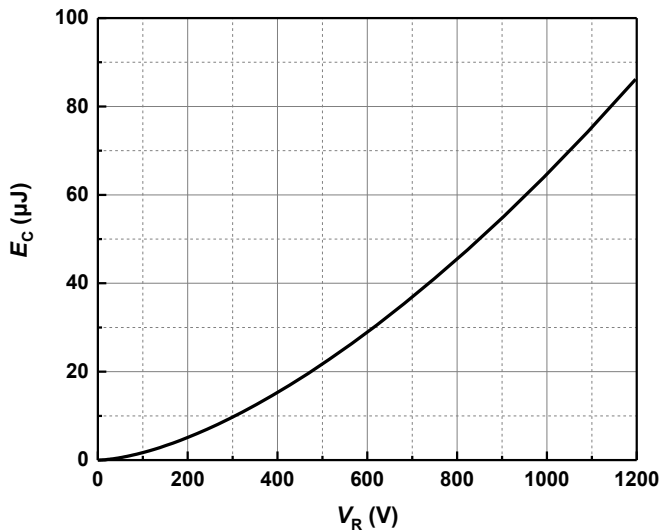
**Typical Performance**



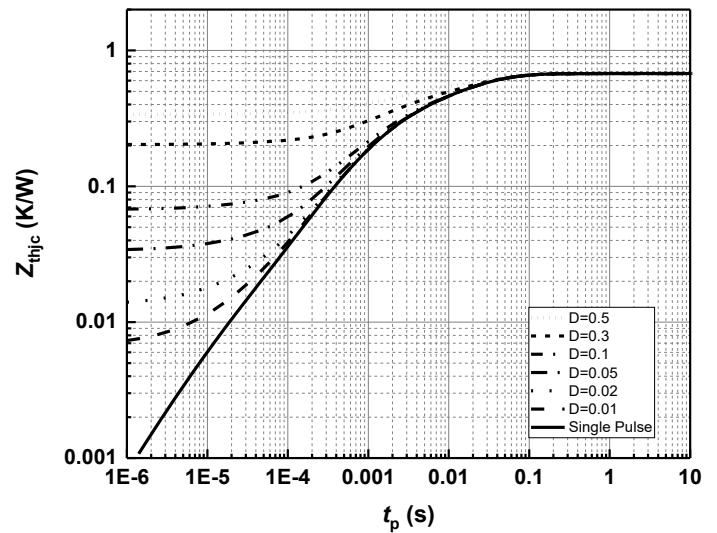
**Figure 5** Typical reverse charge as function of reverse voltage



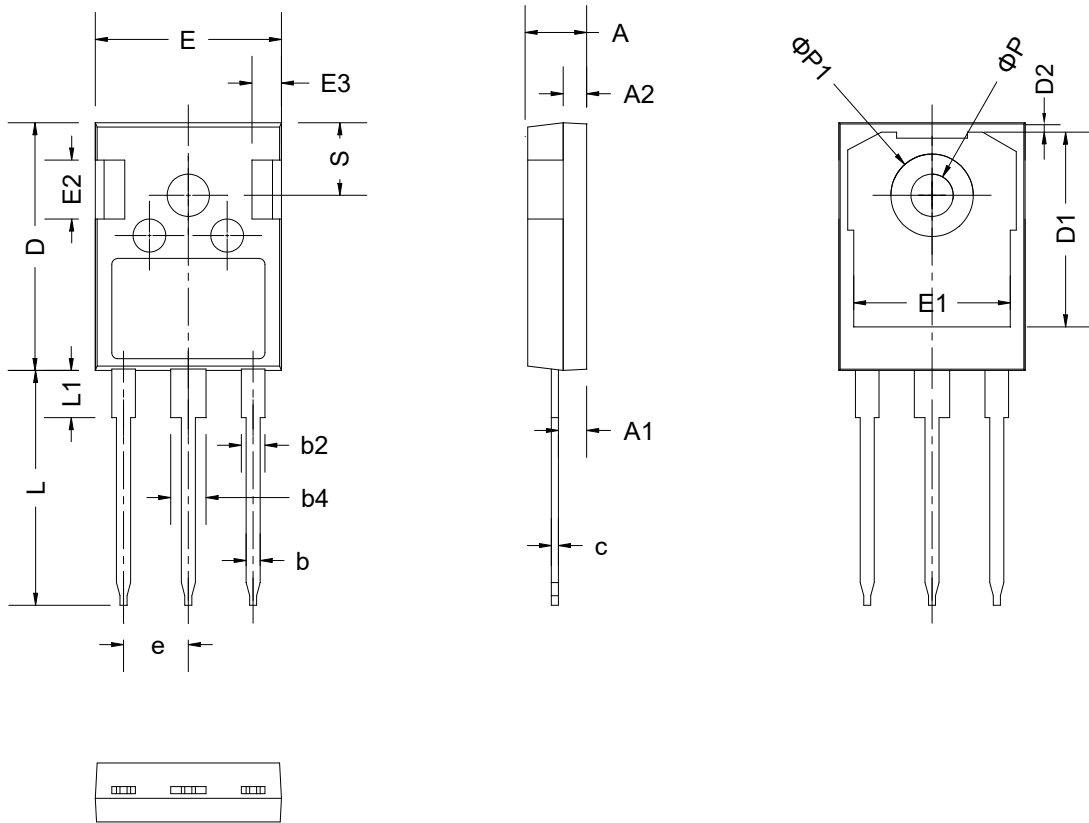
**Figure 6** Power dissipation as function of case temperature



**Figure 7** Capacitance stored energy



**Figure 8** Max. transient thermal impedance,  $Z_{thjc} = f(t)$ , parameter:  $D = t_p / T$

**Package Dimensions**


SYMBOL	mm		
	MIN	NOM	MAX
A	4.80	5.00	5.20
A1	2.21	2.41	2.59
A2	1.85	2.00	2.15
b	1.11	-	1.36
b2	1.91	2.01	2.21
b4	2.91	-	3.41
c	0.51	-	0.75
D	20.80	21.00	21.30
D1	16.25	16.55	16.85
D2	1.05	1.17	1.35
E	15.50	15.80	16.10
E1	13.00	13.30	13.60
E2	4.40	-	5.20
E3	1.50	-	2.70
e	5.436BSC		
L	19.62	19.92	20.22
L1	-	-	4.30
φ P	3.40	3.60	3.80
φ P1	-	-	7.40
S	6.00	6.15	6.30

**Revision History**

<b>Document Version</b>	<b>Date of Release</b>	<b>Description of Changes</b>
Rev 1.0	2022-05-23	Release of the datasheet.

**BASiC Semiconductor Ltd.**  
**Shenzhen, China**  
**© 2022 BASiC Semiconductor Ltd.**  
**All Rights Reserved.**

**Information**

For further information on technology, delivery terms and conditions and prices, please contact the nearest BASiC Semiconductor Office

**Disclaimer**

The information given in this document shall in no event be regarded as a guarantee of conditions or characteristics. With respect to any examples or hints given herein, any typical values stated herein and/or any information regarding the application of the device, BASiC semiconductor Ltd. hereby disclaims any and all warranties and liabilities of any kind, including without limitation, warranties of non-infringement of intellectual property rights of any third party.