

M. K. JUCHHEIM GmbH & Co

36035 Fulda
Germany
Phone (0661) 60 03 - 0
Telex 49 701
Fax (0661) 60 03 - 607

For United Kingdom:
Jumo Instrument
Co. Ltd.

Temple Bank
Riverway, Harlow,
Essex CM20 2TT
Phone (01279) 63 55 33
Fax (01279) 63 52 62

For USA:
Jumo Process
Control Inc.

735 Fox Chase
Coatesville, PA 19320
Phone 610 - 380 - 8002,
800 - 554 JUMO
Fax 610 - 380 - 8009



MEASUREMENT AND CONTROL

Data Sheet 90.2523, Page 1/3

Indoor and outdoor Resistance Thermometers

- for temperatures from -30 to $+80$ °C
- for use in air conditioning
- Protection IP 20 to IP 65
- simple and rapid installation
- for 2-wire, 3-wire or 4-wire circuit connection

Indoor and outdoor resistance thermometers are used mainly in air conditioning systems for measuring the temperature in rooms, in air ducts and outdoors.

Different plastic housings for different forms of protection are available to suit the particular application. Installation requires only two screws; rail-mounted versions are simply clipped into position.

The sensor is normally a Pt 100 temperature sensor to IEC 751 Class B in 2-wire circuit. Continuation in 3-wire or 4-wire circuit, starting from the terminals, is possible.

All versions are also available with built-in 2-wire transmitter, see Data Sheet 90 2604

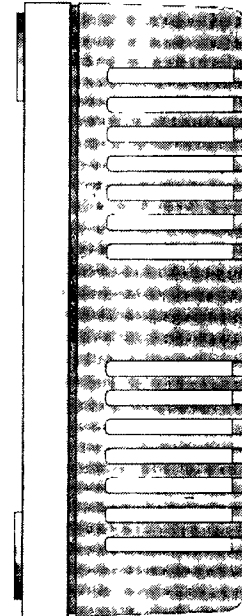

Note: when ordering please specify the Sales No. as shown in Price Sheet 90 2523!

Indoor resistance thermometers for dry areas Protection IP 20

Dimensions in mm	Temperature in °C	Type 1 x Pt 100	Type 2 x Pt 100
see illustration	-30 $+80$	90.262-F05/dl ●	90D262-F05/dl ●

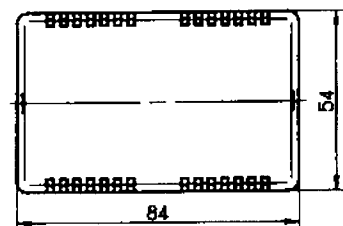

● available from stock /dl = 3-wire circuit

902523

Item 1

M. K. JUCHHEIM GmbH & Co

36035 Fulda
Germany

Phone (0661) 60 03 - 0
Telex 49 701
Fax (0661) 60 03 - 607

For United Kingdom:
Jumo Instrument
Co. Ltd.

Temple Bank
Riverway, Harlow,
Essex CM20 2TT
Phone (01279) 63 55 33
Fax (01279) 63 52 62

For USA:
Jumo Process
Control Inc.

735 Fox Chase
Coatesville, PA 19320
Phone 610 - 380 - 8002.
800 - 554 JUMO
Fax 610 - 380 - 8009



MEASUREMENT AND CONTROL

Data Sheet 90.2523, Page 2/3

Indoor and outdoor resistance thermometers
Protection IP 54

RS 158-4379

Dimensions in mm	Temperature in °C	Type 1 x Pt 100	Type 2 x Pt 100
Case PC plastic see illustration	-30 +80	90 264 ●	90D264 ●

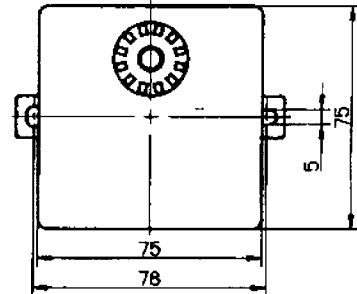
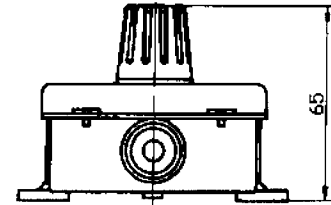

● available from stock

902523

Item 2

Indoor and outdoor resistance thermometers
Protection IP 65

Dimensions in mm	Temperature in °C	Type 1 x Pt 100	Type 2 x Pt 100
Case PC plastic see illustration	-30 +80	90.265-F01 ●	90D265-F01 ●

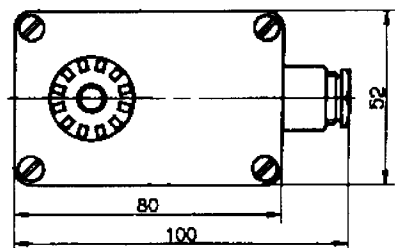
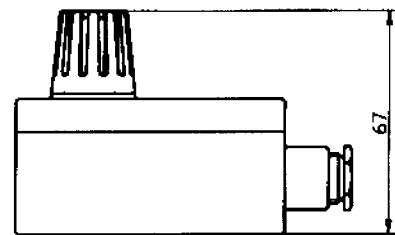

● available from stock

902523

Item 3

M. K. JUCHHEIM Gmbh & Co

36035 Fulda
Germany

Phone (0661) 60 03 - 0
Telex 49 701
Fax (0661) 60 03 - 607

For United Kingdom:
Jumo Instrument
Co. Ltd.

Temple Bank
Riverway, Harlow,
Essex CM20 2TT
Phone (01279) 63 55 33
Fax (01279) 63 52 62

For USA:
Jumo Process
Control Inc.

735 Fox Chase
Coatesville, PA 19320
Phone 610 - 380 - 8002,
800 - 554 JUMO
Fax 610 - 380 - 8009



MEASUREMENT AND CONTROL

Data Sheet 90.2523, Page 3/3

**Indoor and outdoor resistance thermometers with stepped protection tube
Protection IP 65**

Probe length EL in mm	Diameter D in mm	Temperature in °C	Type 1 x Pt 100	Type 2 x Pt 100
55	3.2	-30 +80	90.263-F05 ●	—
55	4.1	-30 +80	—	90D263-F05 ●

Case PC plastic
Protection tube stainless steel X 6 CrNiMoTi 17 12 2, Material Ref. 1.4571

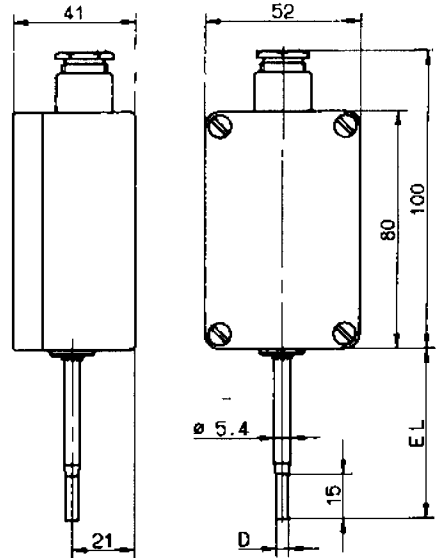

● available from stock

902523

Item 4

**Indoor resistance thermometer for rail mounting
Protection IP 20**

Dimensions in mm	Temperature in °C	Type 1 x Pt 100	Type 2 x Pt 100
---------------------	----------------------	--------------------	--------------------

Case PC plastic

see illustration -30 +80 90 262-F14 ● —

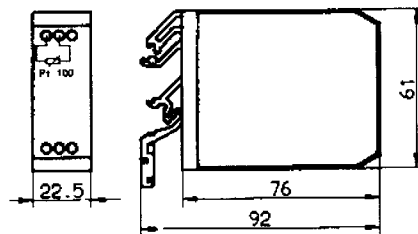

mm	inch
3.2	0.125
4.1	0.161
5	0.20
5.4	0.21
15	0.59
21	0.83
22.5	0.88
31	1.22
41	1.61
52	2.05
54	2.13
55	2.17
61	2.40
65	2.56
67	2.64
75	2.95
76	2.99
78	3.07
80	3.15
84	3.31
92	3.62
100	3.94

Note: for mounting on C rail 35 mm x 7.5 mm EN 50 022
C rail 15 mm EN 50 045
G rail EN 50 035

● available from stock

902523

Item 5