

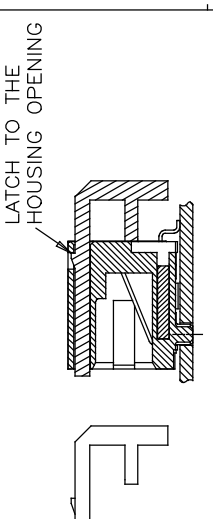

REVISIONS		DATE	APPRD.
SYM ZONE	ECN, ERN NO.		
B	REVISE	2005/07/17	L.CHAN
C	REVISE BOTTOM VIEW	2005/07/25	L.CHAN
D	CORRECT DIMENSION AND PACKAGING QUANTITY	2016/01/15	L.CHAN

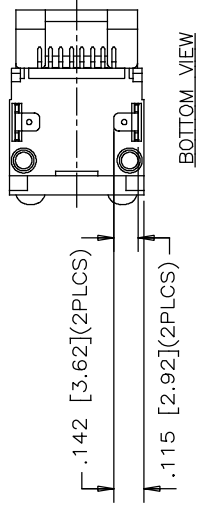

AFTER SOLDER REFLOW, LOAD LIGHT PIPE THROUGH THE CONNECTOR REAR ACCESS IN THE DIRECTION AS SHOWN



MATERIALS:
 PLASTIC HOUSING: ENGINEERING THERMOPLASTIC
 FLAMMABILITY RATING UL 94V-0
 COLOR: BLACK

CONTACTS:
 PHOSPHOR BRONZE
 PLATING: 20 μ [0.51 MICRONS]
 MIN. GOLD ON MATING SURFACES.
 50 μ [1.27 MICRONS]
 MIN. NICKEL UNDERPLATE.
 100 μ [2.54 MICRONS]
 MIN. MATTE TIN ON CONTACT TAILS.

LIGHT PIPE:
 CLEAR POLYCARBONATE
 FLAMMABILITY RATING UL 94V-0

PART NUMBER: RJ SSE-5081-01T

DRAWN	Chigow	DATE	05/07/25
DESIGNED			
CHECKED	L.CHAN		
I. E. APPRD.			
Q. A. APPRD.			
DWG. APPRD.			
ENG. REL. NO.			
REF.			
DWG. DRAWING NO.			
DIMENSIONS ARE IN INCHES [mm]		CODE ID. NO.	03554
SCALE	NTS	WT.	
SURF.			
SHEET	1	OF	2

AMPHENO I	Canada Corp.
TITLE	SURFACE MOUNT MODULAR JACK
	8 POSITION, 8 CONTACTS, UNSHIELDED, WITH LIGHT PIPE, TAPE & REEL PACKAGING, RoHS COMPLIANT.

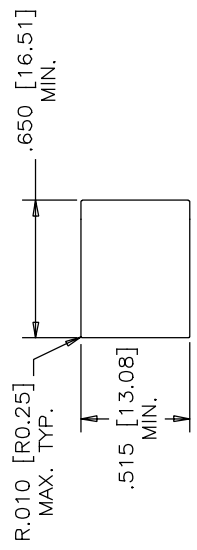

RECOMMENDED PANEL CUTOUT

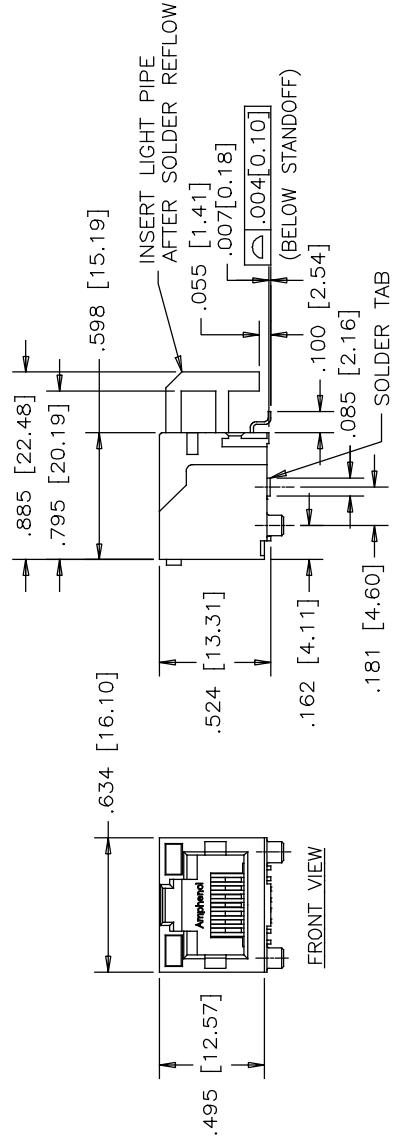

SIDE VIEW

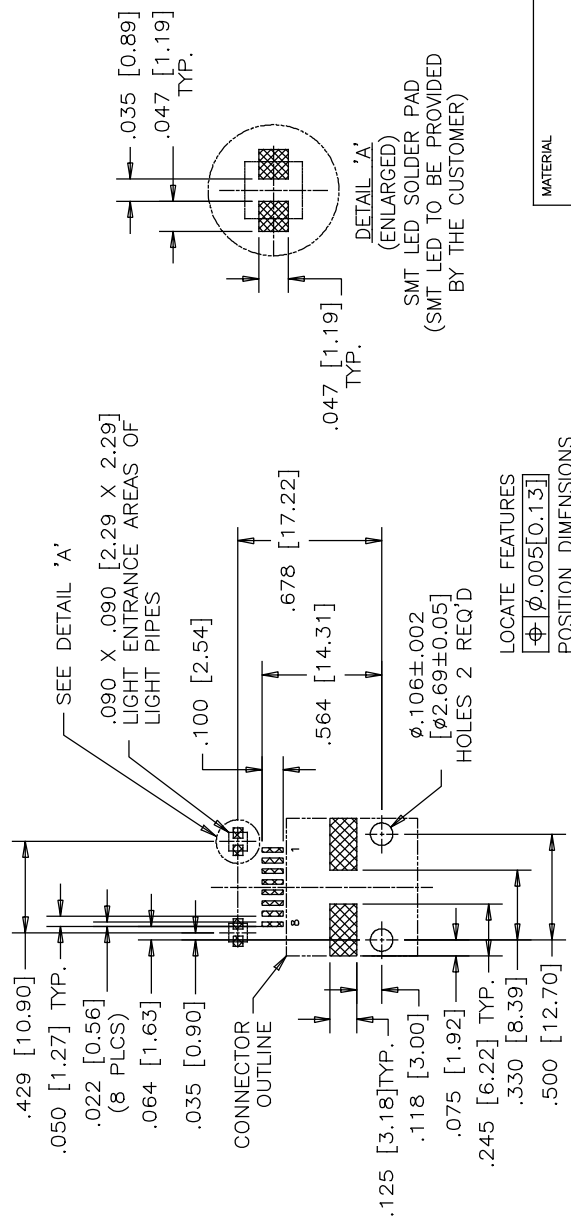

LOCATE FEATURES

Φ [0.005] [0.13]

POSITION DIMENSIONS ARE BASIC

RECOMMENDED P.C.B. LAYOUT (COMPONENT SIDE OF BOARD)

THIS DOCUMENT CONTAINS PROPRIETARY INFORMATION AND SUCH INFORMATION MAY NOT BE DISCLOSED TO OTHERS FOR ANY PURPOSE OR USED FOR MANUFACTURING PURPOSES WITHOUT WRITTEN PERMISSION FROM AMPHENOL CANADA CORP.

REVISIONS			
SYM ZONE	ECN, ERN NO.	DATE	APPRD.
B	REVISE	2005/07/17	L.CHAN
C	REVISE BOTTOM VIEW	2005/07/25	L.CHAN
D	CORRECT DIMENSION AND PACKAGING QUANTITY	2016/01/18	L.CHAN

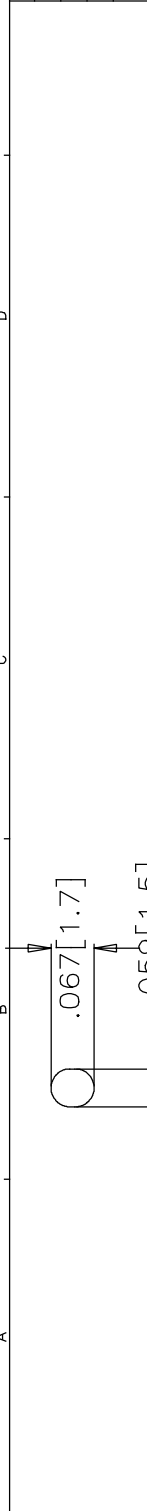
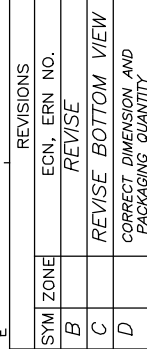
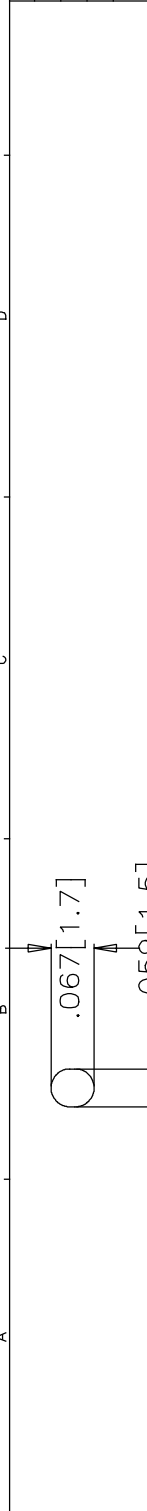

PACKAGING NOTES:

- ONE REEL SHOULD HOLD 100 CONNECTORS.
- 10 EMPTY CAVITIES FOR BOTH TOP AND BOTTOM OF THE CARRIER.
- A FULLY LOADED CARTON SHOULD CONTAIN 5 REELS (500 PCS) OF CONNECTOR.

MATERIAL	DESIGNED	DATE
---	Chigow	05/07/25
---	L.CHAN	05/07/25
---	I. E. APPRD.	
---	Q. A. APPRD.	
---	ENG. REL. NO.	
---	REF.	
---	DIMENSIONS ARE IN INCHES [mm]	03554

FINISH	DWG. NO.	SCALE
---	P-RJSSE-5081-01T	2 OF 2

REV.	DRAWING NO.	SCALE	WT.	SURF.	SHEET
D	P-RJSSE-5081-01T	2 OF 2			

Amphenol Canada Corp.
 TITLE: SURFACE MOUNT MODULAR JACK
 8 POSITION, 8 CONTACTS, UNSHIELDED, WITH LIGHT PIPE, TAPE & REEL PACKAGING, RoHS COMPLIANT.

THIS DOCUMENT CONTAINS PROPRIETARY INFORMATION AND SUCH INFORMATION MAY NOT BE DISCLOSED TO OTHERS FOR ANY PURPOSE OR USED FOR MANUFACTURING PURPOSES WITHOUT WRITTEN PERMISSION FROM AMPHENOL CANADA CORP.