

Cree® XLamp® XP Family LEDs

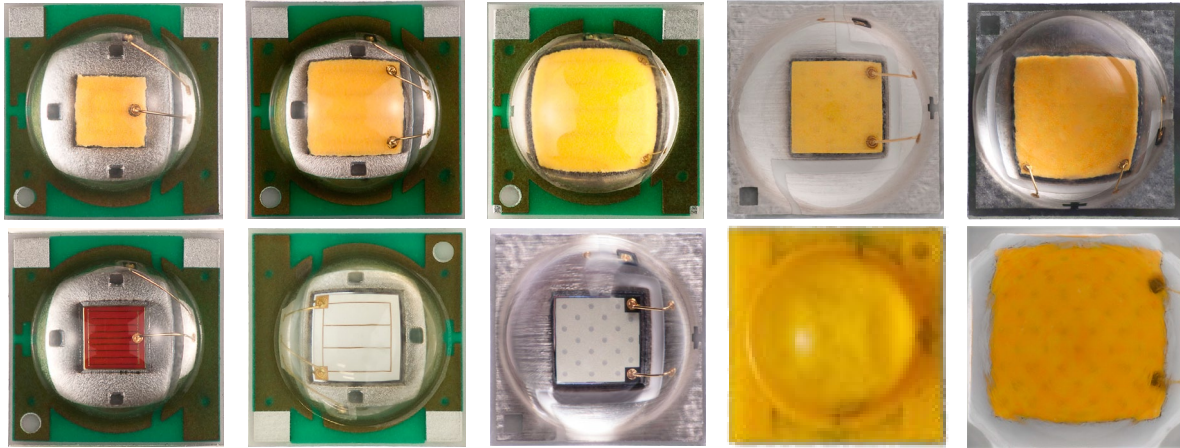

TABLE OF CONTENTS

Introduction.....	2	XP-E2 ANSI Cool White	32
Bin and Order Code Format.....	3	XP-E2 Neutral White, Outdoor White	33
Performance Groups – Brightness	5	XP-E2 Warm White	34
Performance Groups – Radiant Flux.....	6	XP-E2 Color	36
Performance Groups – Chromaticity	7	XP-E HEW ANSI Cool White.....	39
Performance Groups – Dominant Wavelength	12	XP-E HEW Neutral White, Outdoor White	39
Performance Groups – Peak Wavelength	12	XP-G ANSI Cool White.....	42
Performance Groups – Forward Voltage	13	XP-G Neutral White, Outdoor White.....	43
Cree’s Standard Chromaticity Regions Plotted on the 1931 CIE Curve.....	14	XP-G Warm White.....	45
Cree’s Standard Cool White Kits Plotted on ANSI Standard Chromaticity Regions.....	16	XP-G2 ANSI Cool White	47
Cree’s Outdoor White Kits Plotted on ANSI Standard Chromaticity Regions.....	17	XP-G2 Neutral White, Outdoor White.....	48
Cree’s Standard Warm and Neutral White Kits Plotted on ANSI Standard Chromaticity Regions.....	19	XP-G2 Warm White.....	50
Cree’s 2200 K CCT White Kits Plotted on ANSI Standard Chromaticity Regions.....	21	XP-L ANSI Cool White	52
Cree’s PC Amber Kit Plotted on the 1931 CIE Curve.....	21	XP-L Neutral White	53
Cree’s Standard Chromaticity Kits.....	22	XP-L Warm White	54
Standard Order Codes and Pre-ANSI Bins			
XP-C Cool White	23		
Standard Order Codes and Bins			
XP-C ANSI Cool White.....	23		
XP-C Neutral White.....	24		
XP-C Warm White.....	25		
XP-C Color.....	25		
XP-E Cool White	27		
XP-E ANSI Cool White	27		
XP-E Neutral White, Outdoor White.....	28		
XP-E Warm White	29		
XP-E Color.....	30		

INTRODUCTION

This document describes the product nomenclature required to select and order Cree's XLamp® XP Family LEDs. XLamp XP Family LEDs are tested and sorted into bins which are then combined into orderable kits identified by an order code.

All XLamp LEDs are tested and sorted by color and brightness into a unique bin. Each bin contains LEDs from only one color and brightness group and is uniquely identified by a bin code. White XLamp LEDs are sorted by chromaticity (color) and luminous flux (brightness). High-Efficiency White (HEW) XLamp LEDs are additionally binned into forward voltage bins. Color XLamp LEDs are sorted by dominant or peak wavelength (color) and luminous or radiant flux (brightness). Amber, red-orange and red LEDs are additionally binned into forward voltage bins. LEDs are shipped on reels containing LEDs from one bin and are always labeled with the appropriate bin code.

Kits contain LEDs from a number of similar bins and are fully defined by their order codes. A full explanation of the order codes for XLamp XP Family LEDs, as well as a list of standard order codes, is provided in this document.

BIN AND ORDER CODE FORMAT

XP-C, XP-E, XP-E2, XP-E HEW, XP-G and XP-G2 bin codes and order codes are configured in the following manner:

Order Code

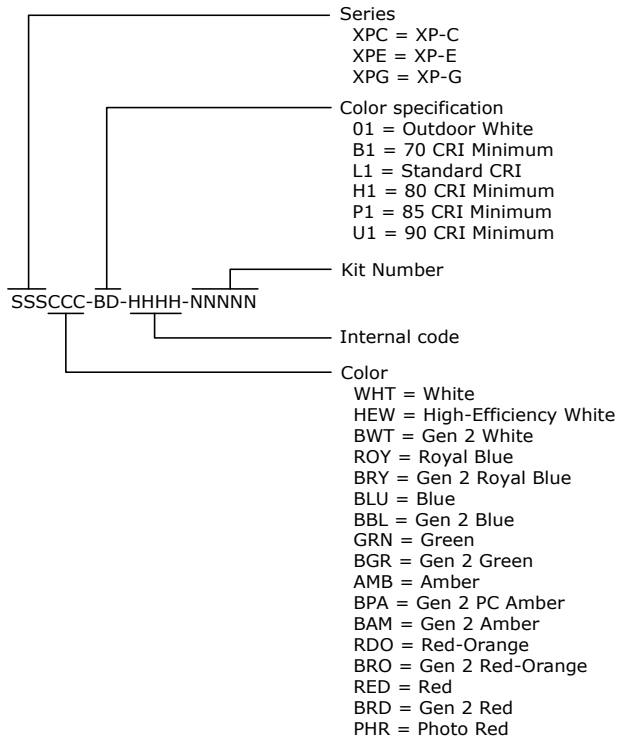

Bin Code

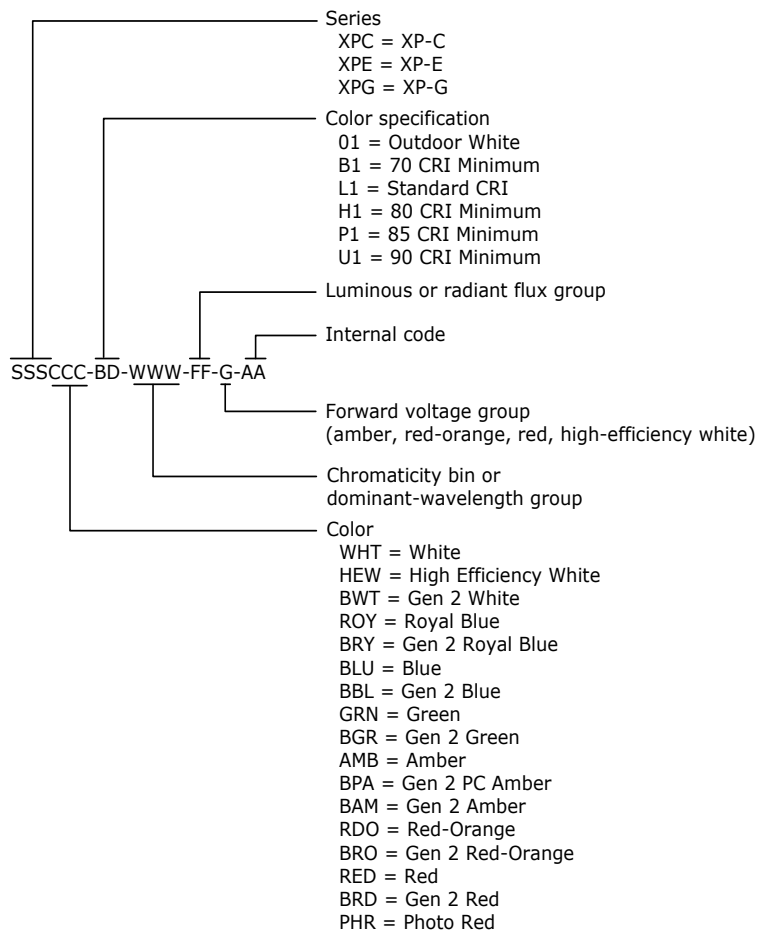

BIN AND ORDER CODE FORMAT - CONTINUED

XP-L bin codes and order codes are configured in the following manner:

Order Code

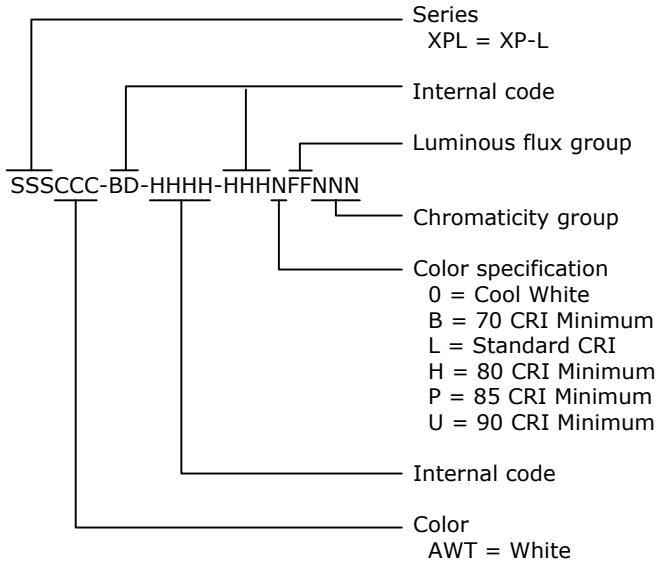

Bin Code

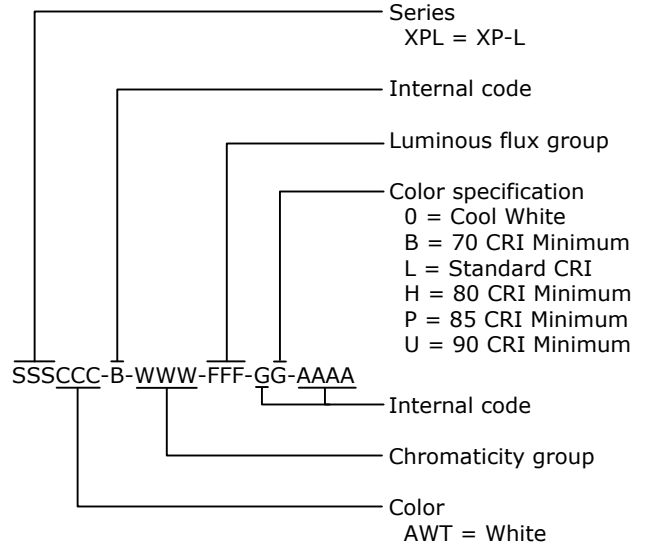

PERFORMANCE GROUPS – BRIGHTNESS

XLamp XP Family LEDs (except royal blue, photo red and XP-L) are tested for luminous flux and placed into one of the following luminous-flux groups:

Group Code	Min. Luminous Flux @ 350 mA (lm)	Max. Luminous Flux @ 350 mA (lm)
J	23.5	30.6
K2	30.6	35.2
K3	35.2	39.8
M2	39.8	45.7
M3	45.7	51.7
N2	51.7	56.8
N3	56.8	62.0
N4	62.0	67.2
P2	67.2	73.9
P3	73.9	80.6
P4	80.6	87.4
Q2	87.4	93.9
Q3	93.9	100
Q4	100	107
Q5	107	114
R2	114	122
R3	122	130
R4	130	139
R5	139	148
S2	148	156
S3	156	164

XLamp XP-L LEDs are tested for luminous flux and placed into one of the following luminous-flux groups:

Group Code	Min. Luminous Flux @ 1050 mA (lm)	Max. Luminous Flux @ 1050 mA (lm)
T5	260	280
T6	280	300
U2	300	320
U3	320	340
U4	340	360
U5	360	380
U6	380	400
V2	400	420
V3	420	440
V4	440	460
V5	460	480
V6	480	500

PERFORMANCE GROUPS – RADIANT FLUX ($T_j = 25\text{ }^\circ\text{C}$)

XLamp XP-C and XP-E royal blue and XP-E photo red LEDs are tested for radiant flux and sorted into one of the following radiant-flux bins:

Group	Minimum Radiant Flux (mW) @ 350 mA	Maximum Radiant Flux (mW) @ 350 mA
12	250	300
13	300	350
14	350	425
15	425	500
16	500	600

XLamp XP-E2 royal blue LEDs are tested for radiant flux and placed into one the following bins:

Group	Minimum Radiant Flux (mW) @ 350 mA	Maximum Radiant Flux (mW) @ 350 mA
31 (K)	475	500
32 (L)	500	525
33 (M)	525	550
34 (N)	550	575
35 (P)	575	600
36 (Q)	600	625

PERFORMANCE GROUPS – CHROMATICITY

White XLamp LEDs are tested for chromaticity and placed into one of the regions defined by the bounding coordinates on the following pages.

Region	x	y	Region	x	y
WK	.283	.284	WF	.314	.355
	.295	.297		.316	.332
	.298	.288		.306	.322
	.287	.276		.301	.342
WA	.292	.306	WP	.317	.319
	.295	.297		.329	.330
	.283	.284		.329	.318
	.279	.291		.318	.308
WM	.295	.297	WD	.329	.345
	.308	.311		.329	.330
	.310	.300		.317	.319
	.298	.288		.316	.332
WB	.306	.322	WG	.329	.369
	.308	.311		.329	.345
	.295	.297		.316	.332
	.292	.306		.314	.355
WE	.301	.342	WJ	.329	.330
	.306	.322		.329	.345
	.292	.306		.346	.359
	.287	.321		.344	.342
WN	.308	.311	WH	.348	.384
	.317	.319		.346	.359
	.318	.308		.329	.345
	.310	.300		.329	.369
WC	.316	.332			
	.317	.319			
	.308	.311			
	.306	.322			

PERFORMANCE GROUPS – CHROMATICITY (CONTINUED)

Region	x	y	Region	x	y	Region	x	y	Region	x	y
0A	0.2950	0.2970	0B	0.2920	0.3060	0C	0.2984	0.3133	0D	0.2984	0.3133
	0.2920	0.3060		0.2895	0.3135		0.2962	0.3220		0.3048	0.3207
	0.2984	0.3133		0.2962	0.3220		0.3028	0.3304		0.3068	0.3113
	0.3009	0.3042		0.2984	0.3133		0.3048	0.3207		0.3009	0.3042
0R	0.2980	0.2880	0S	0.2895	0.3135	0T	0.2962	0.3220	0U	0.3037	0.2937
	0.2950	0.2970		0.2870	0.3210		0.2937	0.3312		0.3009	0.3042
	0.3009	0.3042		0.2937	0.3312		0.3005	0.3415		0.3068	0.3113
	0.3037	0.2937		0.2962	0.3220		0.3028	0.3304		0.3093	0.2993
1A	0.3048	0.3207	1B	0.3028	0.3304	1C	0.3115	0.3391	1D	0.3130	0.3290
	0.3130	0.3290		0.3115	0.3391		0.3205	0.3481		0.3213	0.3373
	0.3144	0.3186		0.3130	0.3290		0.3213	0.3373		0.3221	0.3261
	0.3068	0.3113		0.3048	0.3207		0.3130	0.3290		0.3144	0.3186
1R	0.3068	0.3113	1S	0.3005	0.3415	1T	0.3099	0.3509	1U	0.3144	0.3186
	0.3144	0.3186		0.3099	0.3509		0.3196	0.3602		0.3221	0.3261
	0.3161	0.3059		0.3115	0.3391		0.3205	0.3481		0.3231	0.3120
	0.3093	0.2993		0.3028	0.3304		0.3115	0.3391		0.3161	0.3059
2A	0.3215	0.3350	2B	0.3207	0.3462	2C	0.3290	0.3538	2D	0.3290	0.3417
	0.3290	0.3417		0.3290	0.3538		0.3376	0.3616		0.3371	0.3490
	0.3290	0.3300		0.3290	0.3417		0.3371	0.3490		0.3366	0.3369
	0.3222	0.3243		0.3215	0.3350		0.3290	0.3417		0.3290	0.3300
2R	0.3222	0.3243	2S	0.3196	0.3602	2T	0.3290	0.3690	2U	0.3290	0.3300
	0.3290	0.3300		0.3290	0.3690		0.3381	0.3762		0.3366	0.3369
	0.3290	0.3180		0.3290	0.3538		0.3376	0.3616		0.3361	0.3245
	0.3231	0.3120		0.3207	0.3462		0.3290	0.3538		0.3290	0.3180
3A	0.3371	0.3490	3B	0.3376	0.3616	3C	0.3463	0.3687	3D	0.3451	0.3554
	0.3451	0.3554		0.3463	0.3687		0.3551	0.3760		0.3533	0.3620
	0.3440	0.3427		0.3451	0.3554		0.3533	0.3620		0.3515	0.3487
	0.3366	0.3369		0.3371	0.3490		0.3451	0.3554		0.3440	0.3427
3R	0.3366	0.3369	3S	0.3381	0.3762	3T	0.3480	0.3840	3U	0.3440	0.3428
	0.3440	0.3428		0.3480	0.3840		0.3571	0.3907		0.3515	0.3487
	0.3429	0.3307		0.3463	0.3687		0.3551	0.3760		0.3495	0.3339
	0.3361	0.3245		0.3376	0.3616		0.3463	0.3687		0.3429	0.3307
4A	0.3530	0.3597	4B	0.3548	0.3736	4C	0.3641	0.3804	4D	0.3615	0.3659
	0.3615	0.3659		0.3641	0.3804		0.3736	0.3874		0.3702	0.3722
	0.3590	0.3521		0.3615	0.3659		0.3702	0.3722		0.3670	0.3578
	0.3512	0.3465		0.3530	0.3597		0.3615	0.3659		0.3590	0.3521
4R	0.3512	0.3465	4S	0.3571	0.3907	4T	0.3668	0.3957	4U	0.3590	0.3521
	0.3590	0.3521		0.3668	0.3957		0.3771	0.4034		0.3670	0.3578
	0.3567	0.3389		0.3641	0.3804		0.3736	0.3874		0.3640	0.3440
	0.3495	0.3339		0.3548	0.3736		0.3641	0.3804		0.3567	0.3389

PERFORMANCE GROUPS – CHROMATICITY (CONTINUED)

Region	x	y	Region	x	y	Region	x	y	Region	x	y
5A1	0.3670	0.3578	5A2	0.3686	0.3649	5A3	0.3744	0.3685	5A4	0.3726	0.3612
	0.3686	0.3649		0.3702	0.3722		0.3763	0.3760		0.3744	0.3685
	0.3744	0.3685		0.3763	0.3760		0.3825	0.3798		0.3804	0.3721
	0.3726	0.3612		0.3744	0.3685		0.3804	0.3721		0.3783	0.3646
5B1	0.3702	0.3722	5B2	0.3719	0.3797	5B3	0.3782	0.3837	5B4	0.3763	0.3760
	0.3719	0.3797		0.3736	0.3874		0.3802	0.3916		0.3782	0.3837
	0.3782	0.3837		0.3802	0.3916		0.3869	0.3958		0.3847	0.3877
	0.3763	0.3760		0.3782	0.3837		0.3847	0.3877		0.3825	0.3798
5C1	0.3825	0.3798	5C2	0.3847	0.3877	5C3	0.3912	0.3917	5C4	0.3887	0.3836
	0.3847	0.3877		0.3869	0.3958		0.3937	0.4001		0.3912	0.3917
	0.3912	0.3917		0.3937	0.4001		0.4006	0.4044		0.3978	0.3958
	0.3887	0.3836		0.3912	0.3917		0.3978	0.3958		0.3950	0.3875
5D1	0.3783	0.3646	5D2	0.3804	0.3721	5D3	0.3863	0.3758	5D4	0.3840	0.3681
	0.3804	0.3721		0.3825	0.3798		0.3887	0.3836		0.3863	0.3758
	0.3863	0.3758		0.3887	0.3836		0.3950	0.3875		0.3924	0.3794
	0.3840	0.3681		0.3863	0.3758		0.3924	0.3794		0.3898	0.3716
5R	0.3670	0.3578	5S	0.3771	0.4034	5T	0.3916	0.4127	5U	0.3783	0.3646
	0.3783	0.3646		0.3916	0.4127		0.4064	0.4221		0.3898	0.3716
	0.3743	0.3502		0.3869	0.3958		0.4006	0.4044		0.3848	0.3565
	0.3640	0.3440		0.3736	0.3874		0.3869	0.3958		0.3743	0.3502
6A1	0.3889	0.3690	6A2	0.3915	0.3768	6A3	0.3981	0.3800	6A4	0.3953	0.3720
	0.3915	0.3768		0.3941	0.3848		0.4010	0.3882		0.3981	0.3800
	0.3981	0.3800		0.4010	0.3882		0.4080	0.3916		0.4048	0.3832
	0.3953	0.3720		0.3981	0.3800		0.4048	0.3832		0.4017	0.3751
6B1	0.3941	0.3848	6B2	0.3968	0.3930	6B3	0.4040	0.3966	6B4	0.4010	0.3882
	0.3968	0.3930		0.3996	0.4015		0.4071	0.4052		0.4040	0.3966
	0.4040	0.3966		0.4071	0.4052		0.4146	0.4089		0.4113	0.4001
	0.4010	0.3882		0.4040	0.3966		0.4113	0.4001		0.4080	0.3916
6C1	0.4080	0.3916	6C2	0.4113	0.4001	6C3	0.4186	0.4037	6C4	0.4150	0.3950
	0.4113	0.4001		0.4146	0.4089		0.4222	0.4127		0.4186	0.4037
	0.4186	0.4037		0.4222	0.4127		0.4299	0.4165		0.4259	0.4073
	0.4150	0.3950		0.4186	0.4037		0.4259	0.4073		0.4221	0.3984
6D1	0.4017	0.3751	6D2	0.4048	0.3832	6D3	0.4116	0.3865	6D4	0.4082	0.3782
	0.4048	0.3832		0.4080	0.3916		0.4150	0.3950		0.4116	0.3865
	0.4116	0.3865		0.4150	0.3950		0.4221	0.3984		0.4183	0.3898
	0.4082	0.3782		0.4116	0.3865		0.4183	0.3898		0.4147	0.3814
6R	0.3889	0.3690	6S	0.4054	0.4191	6T	0.4217	0.4273	6U	0.4017	0.3751
	0.4017	0.3751		0.4217	0.4273		0.4382	0.4356		0.4147	0.3814
	0.3957	0.3596		0.4146	0.4089		0.4299	0.4165		0.4077	0.3652
	0.3840	0.3540		0.3996	0.4015		0.4146	0.4089		0.3957	0.3596

PERFORMANCE GROUPS – CHROMATICITY (CONTINUED)

Region	x	y	Region	x	y	Region	x	y	Region	x	y
7A1	0.4147	0.3814	7A2	0.4183	0.3898	7A3	0.4242	0.3919	7A4	0.4203	0.3833
	0.4183	0.3898		0.4221	0.3984		0.4281	0.4006		0.4242	0.3919
	0.4242	0.3919		0.4281	0.4006		0.4342	0.4028		0.4300	0.3939
	0.4203	0.3833		0.4242	0.3919		0.4300	0.3939		0.4259	0.3853
7B1	0.4221	0.3984	7B2	0.4259	0.4073	7B3	0.4322	0.4096	7B4	0.4281	0.4006
	0.4259	0.4073		0.4299	0.4165		0.4364	0.4188		0.4322	0.4096
	0.4322	0.4096		0.4364	0.4188		0.4430	0.4212		0.4385	0.4119
	0.4281	0.4006		0.4322	0.4096		0.4385	0.4119		0.4342	0.4028
7C1	0.4342	0.4028	7C2	0.4385	0.4119	7C3	0.4449	0.4141	7C4	0.4403	0.4049
	0.4385	0.4119		0.4430	0.4212		0.4496	0.4236		0.4449	0.4141
	0.4449	0.4141		0.4496	0.4236		0.4562	0.4260		0.4513	0.4164
	0.4403	0.4049		0.4449	0.4141		0.4513	0.4164		0.4465	0.4071
7D1	0.4259	0.3853	7D2	0.4300	0.3939	7D3	0.4359	0.3960	7D4	0.4316	0.3873
	0.4300	0.3939		0.4342	0.4028		0.4403	0.4049		0.4359	0.3960
	0.4359	0.3960		0.4403	0.4049		0.4465	0.4071		0.4418	0.3981
	0.4316	0.3873		0.4359	0.3960		0.4418	0.3981		0.4373	0.3893
8A1	0.4373	0.3893	8A2	0.4418	0.3981	8A3	0.4475	0.3994	8A4	0.4428	0.3906
	0.4418	0.3981		0.4465	0.4071		0.4523	0.4085		0.4475	0.3994
	0.4475	0.3994		0.4523	0.4085		0.4582	0.4099		0.4532	0.4008
	0.4428	0.3906		0.4475	0.3994		0.4532	0.4008		0.4483	0.3919
8B1	0.4465	0.4071	8B2	0.4513	0.4164	8B3	0.4573	0.4178	8B4	0.4523	0.4085
	0.4513	0.4164		0.4562	0.4260		0.4624	0.4274		0.4573	0.4178
	0.4573	0.4178		0.4624	0.4274		0.4687	0.4289		0.4634	0.4193
	0.4523	0.4085		0.4573	0.4178		0.4634	0.4193		0.4582	0.4099
8C1	0.4582	0.4099	8C2	0.4634	0.4193	8C3	0.4695	0.4207	8C4	0.4641	0.4112
	0.4634	0.4193		0.4687	0.4289		0.4750	0.4304		0.4695	0.4207
	0.4695	0.4207		0.4750	0.4304		0.4813	0.4319		0.4756	0.4221
	0.4641	0.4112		0.4695	0.4207		0.4756	0.4221		0.4700	0.4126
8D1	0.4483	0.3919	8D2	0.4532	0.4008	8D3	0.4589	0.4021	8D4	0.4538	0.3931
	0.4532	0.4008		0.4582	0.4099		0.4641	0.4112		0.4589	0.4021
	0.4589	0.4021		0.4641	0.4112		0.4700	0.4126		0.4646	0.4034
	0.4538	0.3931		0.4589	0.4021		0.4646	0.4034		0.4593	0.3944
AA1	0.4822	0.3973	AA2	0.4884	0.4067	AA3	0.4942	0.4066	AA4	0.4879	0.3972
	0.4884	0.4067		0.4946	0.4162		0.5006	0.4160		0.4942	0.4066
	0.4942	0.4066		0.5006	0.4160		0.5066	0.4158		0.5001	0.4064
	0.4879	0.3972		0.4942	0.4066		0.5001	0.4064		0.4936	0.3970
AB1	0.4946	0.4162	AB2	0.5008	0.4256	AB3	0.5069	0.4254	AB4	0.5006	0.4160
	0.5008	0.4256		0.5070	0.4350		0.5133	0.4348		0.5069	0.4254
	0.5069	0.4254		0.5133	0.4348		0.5196	0.4346		0.5131	0.4252
	0.5006	0.4160		0.5069	0.4254		0.5131	0.4252		0.5066	0.4158

PERFORMANCE GROUPS – CHROMATICITY (CONTINUED)

Region	x	y	Region	x	y	Region	x	y	Region	x	y
AC1	0.5066	0.4158	AC2	0.5131	0.4252	AC3	0.5192	0.4250	AC4	0.5126	0.4156
	0.5131	0.4252		0.5196	0.4346		0.5258	0.4343		0.5192	0.4250
	0.5192	0.4250		0.5258	0.4343		0.5321	0.4341		0.5253	0.4248
	0.5126	0.4156		0.5192	0.4250		0.5253	0.4248		0.5186	0.4154
AD1	0.4936	0.3970	AD2	0.5001	0.4064	AD3	0.5059	0.4062	AD4	0.4993	0.3969
	0.5001	0.4064		0.5066	0.4158		0.5126	0.4156		0.5059	0.4062
	0.5059	0.4062		0.5126	0.4156		0.5186	0.4154		0.5118	0.4061
	0.4993	0.3969		0.5059	0.4062		0.5118	0.4061		0.5050	0.3967

XLamp XP-E2 PC amber LEDs are placed into the region defined by the following bounding coordinates.

Region	x	y
Y2	0.5469	0.4249
	0.5700	0.4100
	0.5900	0.4100
	0.5610	0.4390

PERFORMANCE GROUPS – DOMINANT WAVELENGTH

Color XLamp LEDs are tested for dominant wavelength (DWL) and sorted into one of the DWL bins defined below.

Color	DWL Group	Min. DWL (nm) @ 350 mA	Max. DWL (nm) @ 350 mA
Royal Blue	D3	450	455
	D4	455	460
	D5	460	465
Blue	B3	465	470
	B4	470	475
	B5	475	480
	B6	480	485
Green	G2	520	525
	G3	525	530
	G4	530	535
Amber	A2	585	590
	A3	590	595
Red-Orange	O3	610	615
	O4	615	620
Red	R2	620	625
	R3	625	630

PERFORMANCE GROUPS – PEAK WAVELENGTH

Photo red XLamp LEDs are tested for peak wavelength (PWL) and sorted into one of the PWL bins defined below.

Color	PWL Group	Min. PWL (nm) @ 350 mA	Max. PWL (nm) @ 350 mA
Photo Red	P2	650	655
	P3	655	660
	P4	660	665
	P5	665	670

PERFORMANCE GROUPS – FORWARD VOLTAGE

Amber, red-orange, red and High-Efficiency White XLamp LEDs are tested for forward voltage and sorted into one of the forward voltage bins defined below.

Forward Voltage Group	Min. Forward Voltage @ 350 mA	Max. Forward Voltage @ 350 mA
B	1.75	2.0
C	2.0	2.25
D	2.25	2.5
E	2.5	2.75
F	2.75	3.0
G	3.0	3.25
H	3.25	3.5
J	3.5	3.75

CREE'S STANDARD CHROMATICITY REGIONS PLOTTED ON THE 1931 CIE CURVE

Cool White

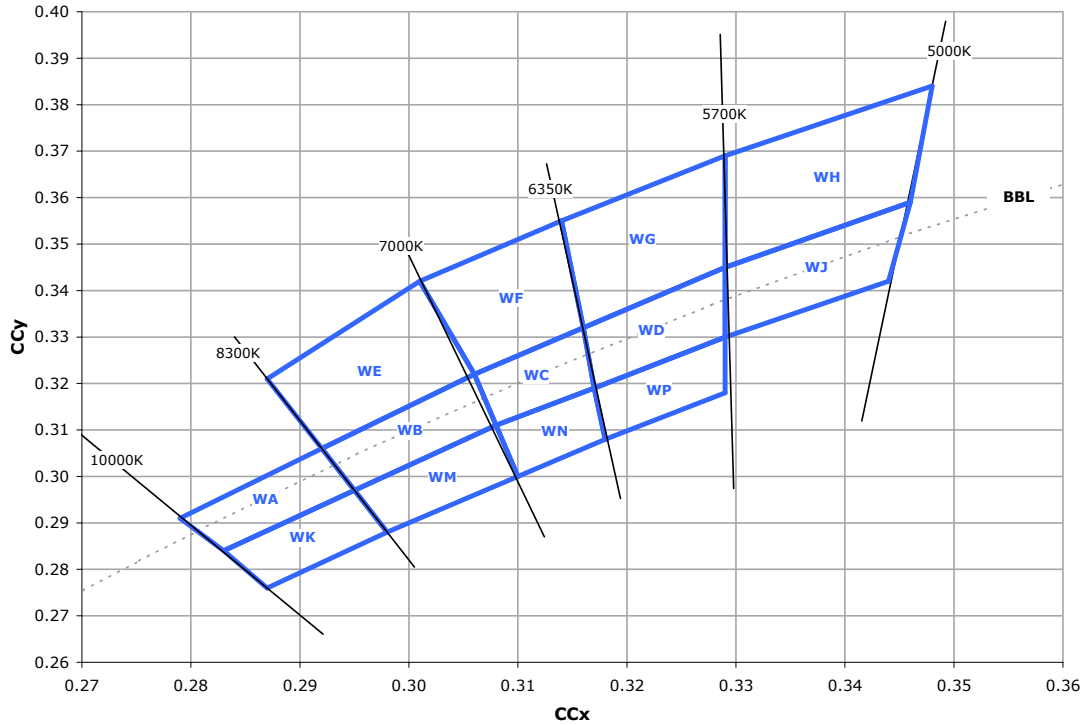

ANSI Cool White

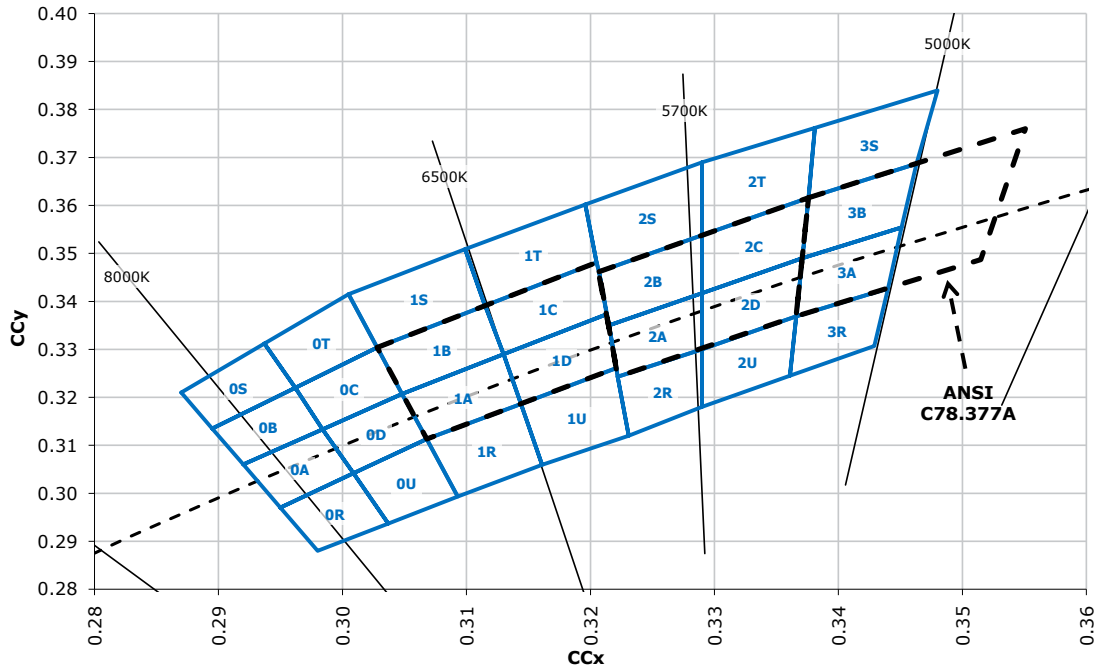

CREE'S STANDARD CHROMATICITY REGIONS PLOTTED ON THE 1931 CIE CURVE (CONTINUED)

Neutral White

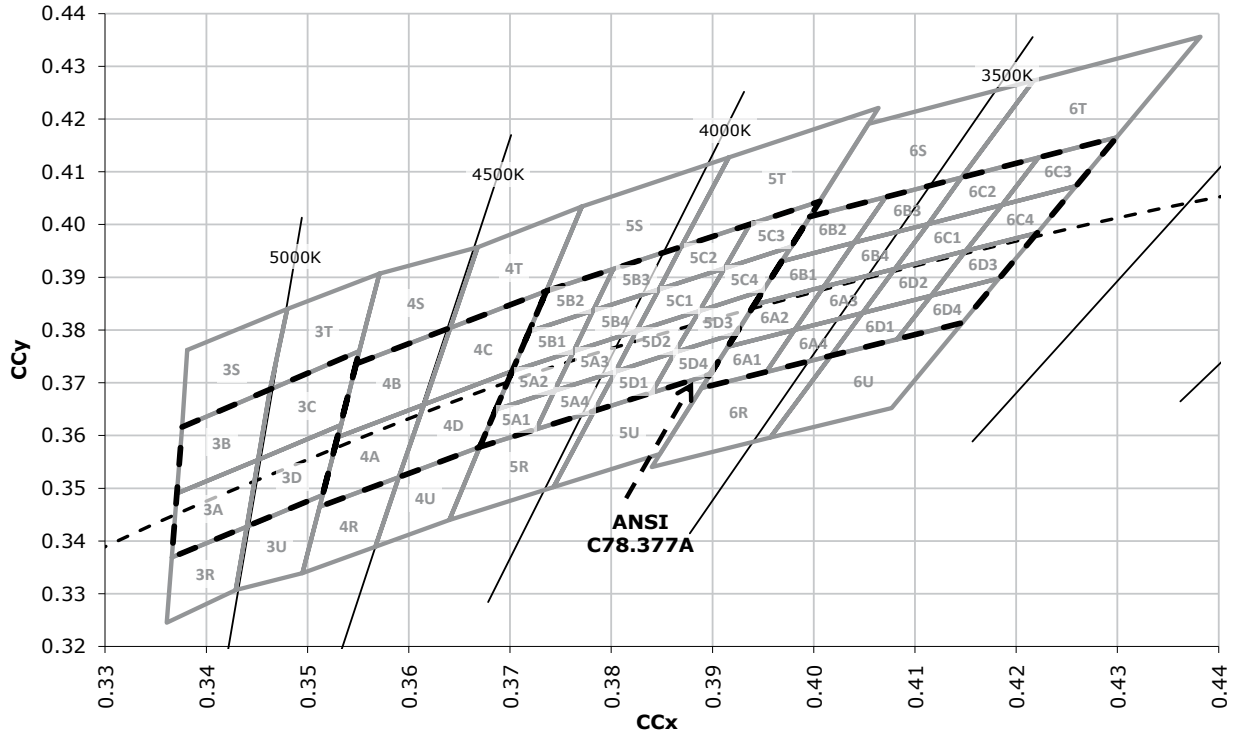

ANSI Neutral White and ANSI Warm White

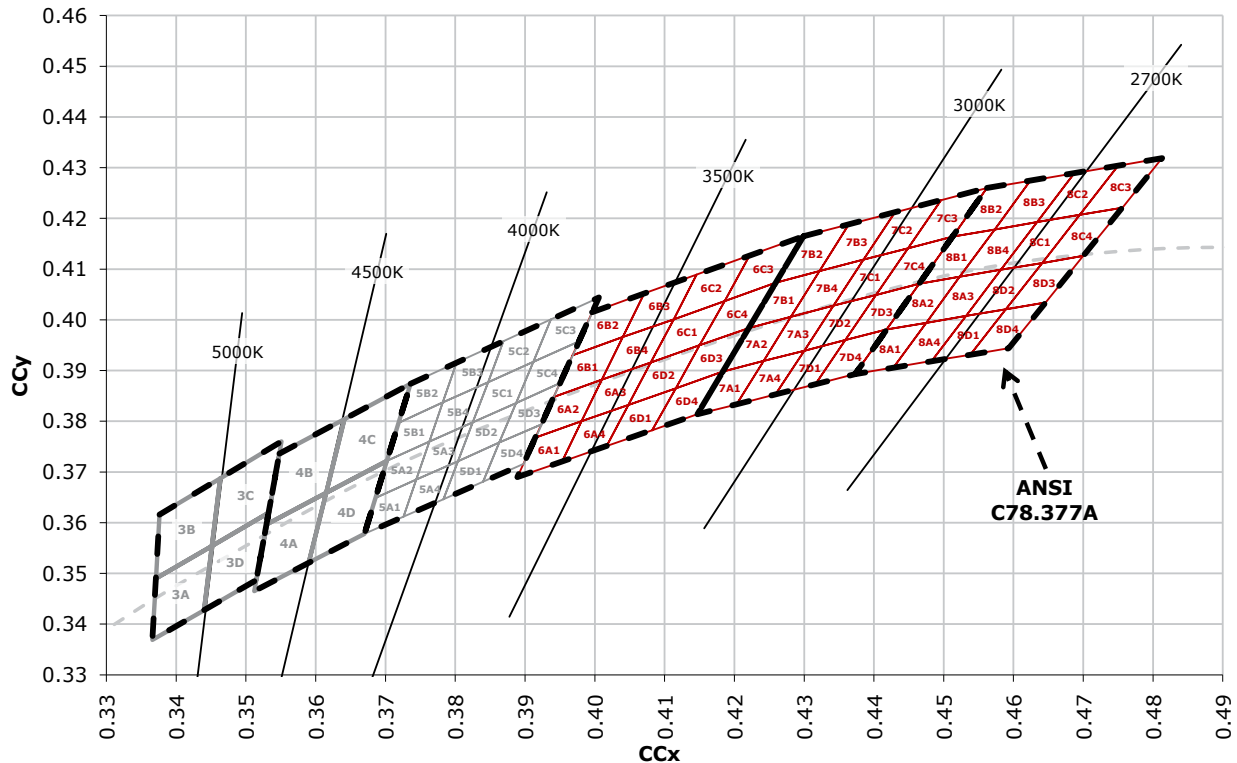

CREE'S STANDARD COOL WHITE KITS PLOTTED ON ANSI STANDARD CHROMATICITY REGIONS

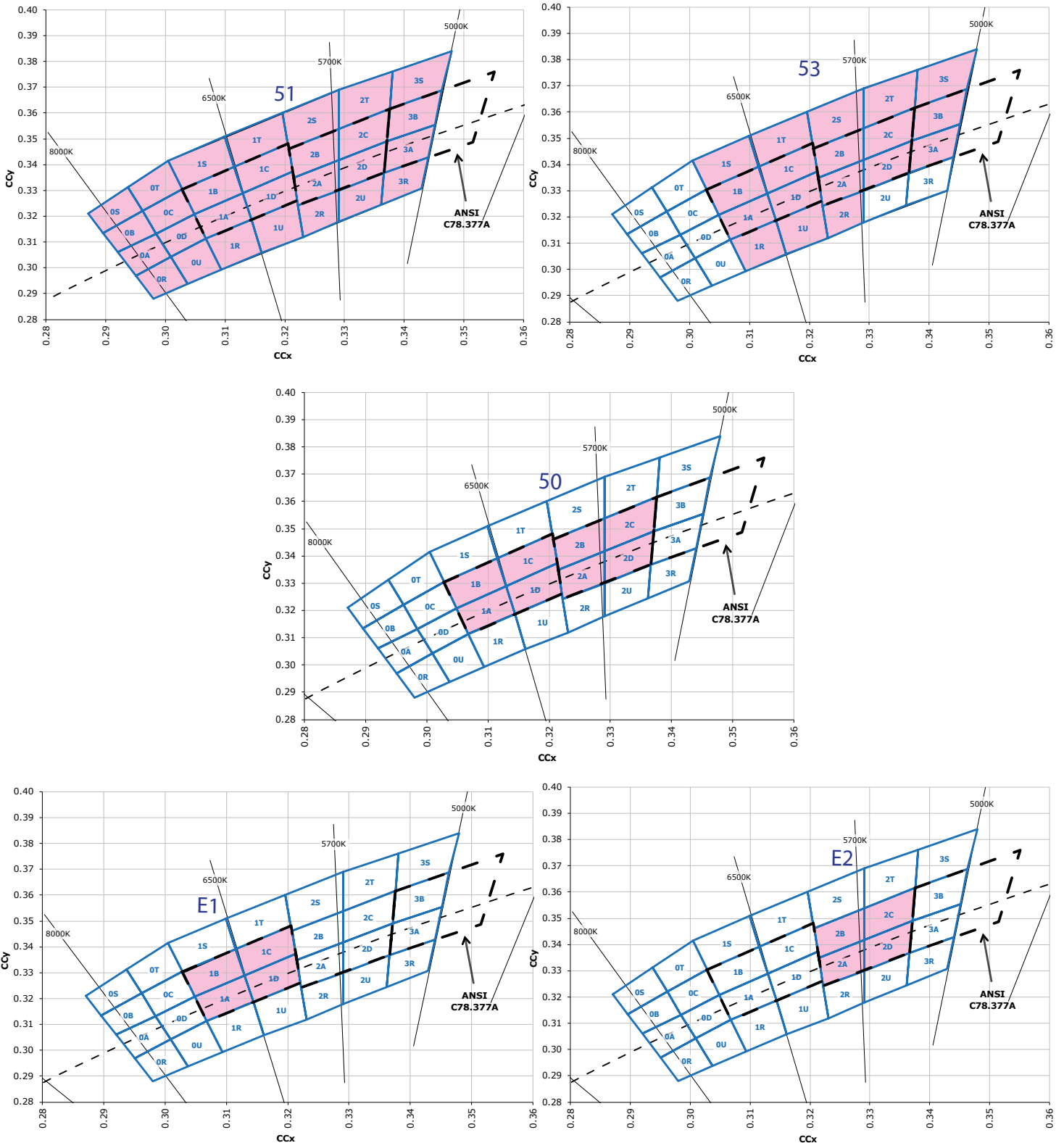

CREE'S OUTDOOR WHITE KITS PLOTTED ON ANSI STANDARD CHROMATICITY REGIONS

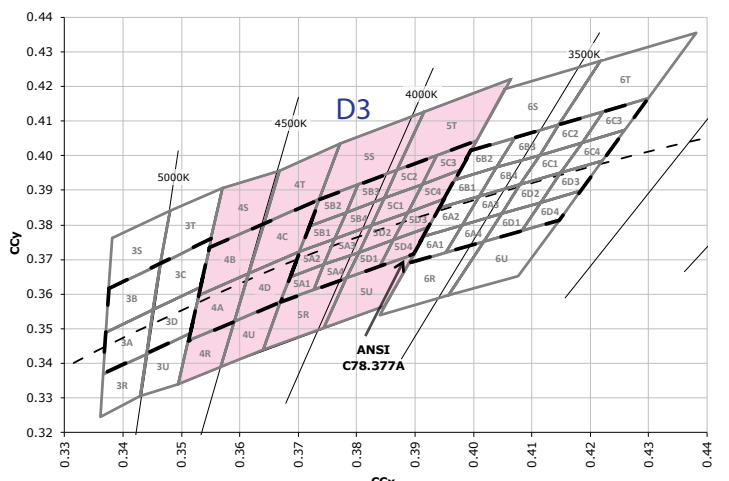
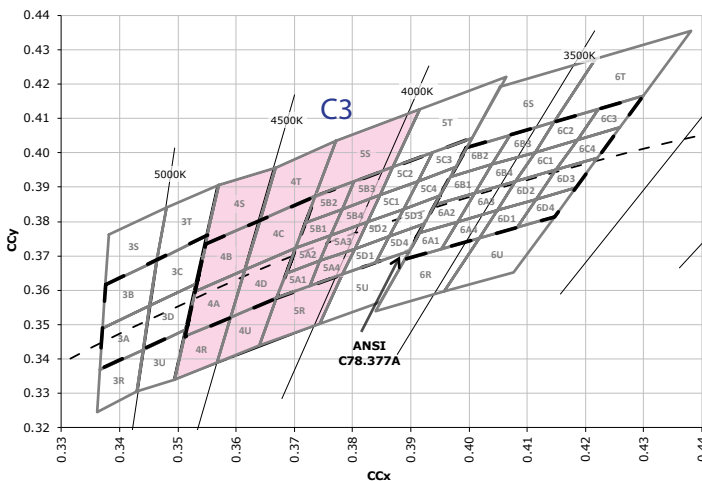
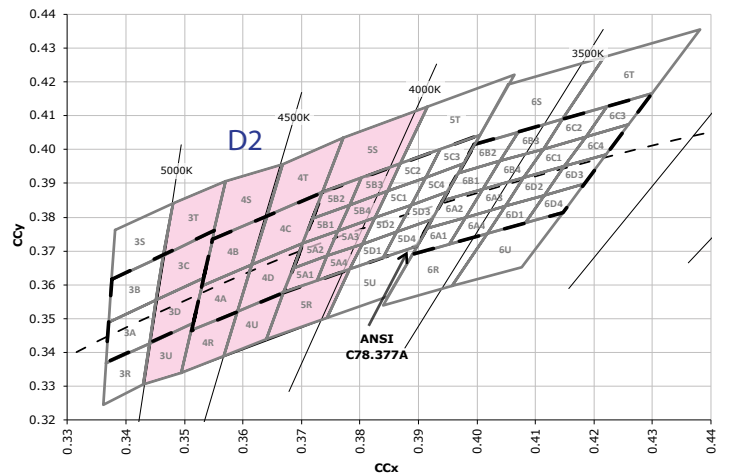
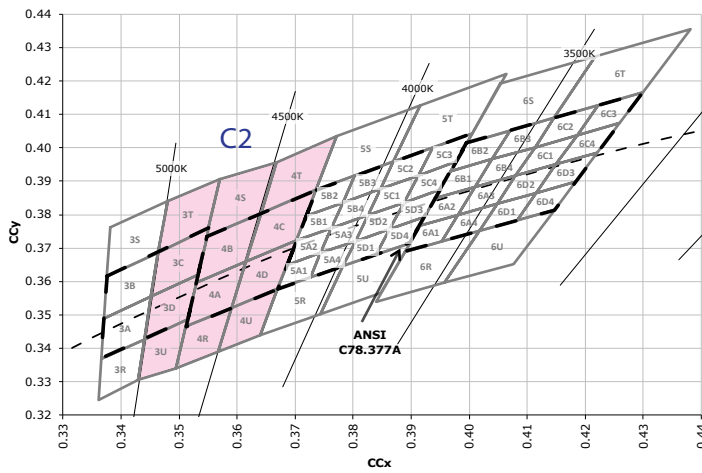
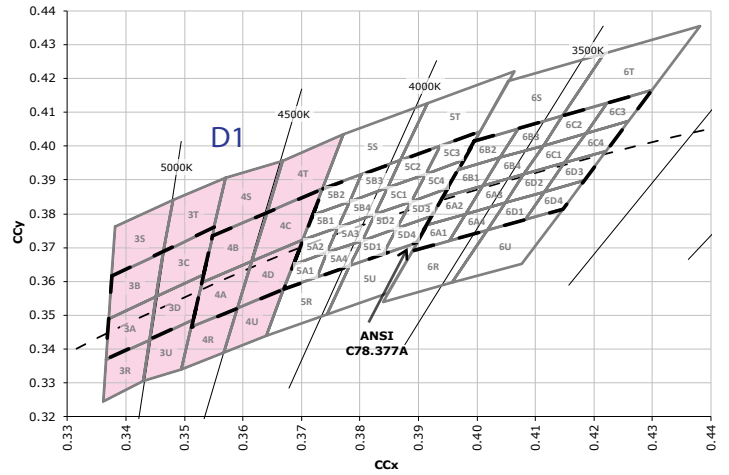
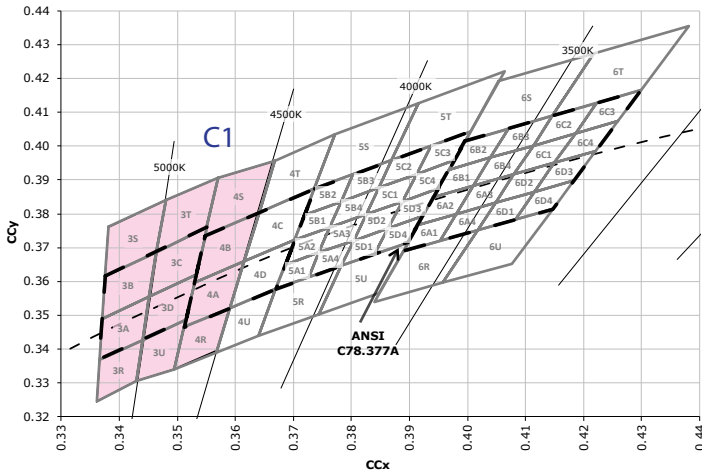

CREE'S OUTDOOR WHITE KITS PLOTTED ON ANSI STANDARD CHROMATICITY REGIONS (CONTINUED)

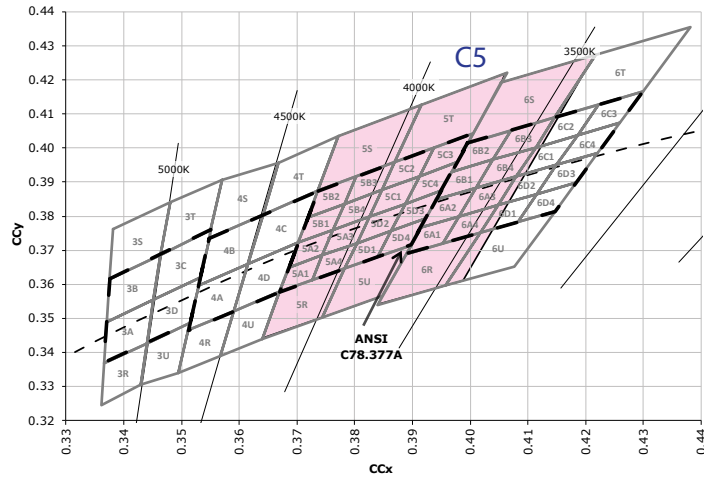
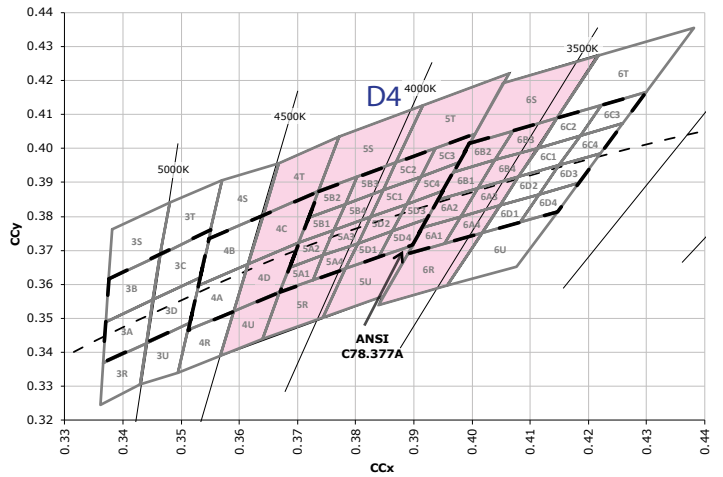
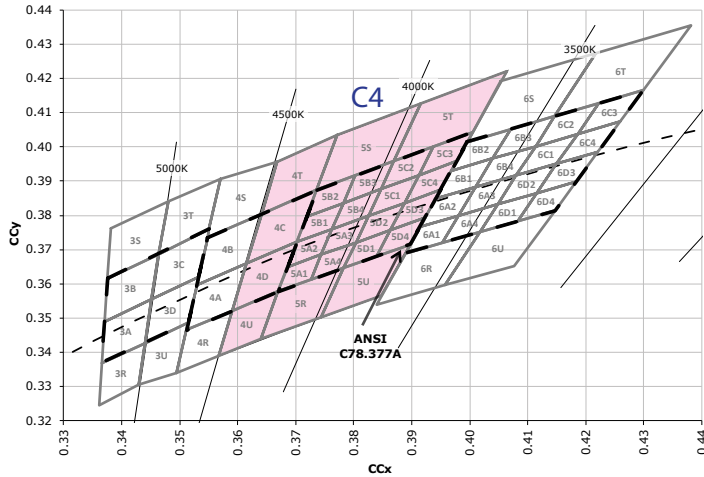

CREE'S STANDARD WARM AND NEUTRAL WHITE KITS PLOTTED ON ANSI STANDARD CHROMATICITY REGIONS

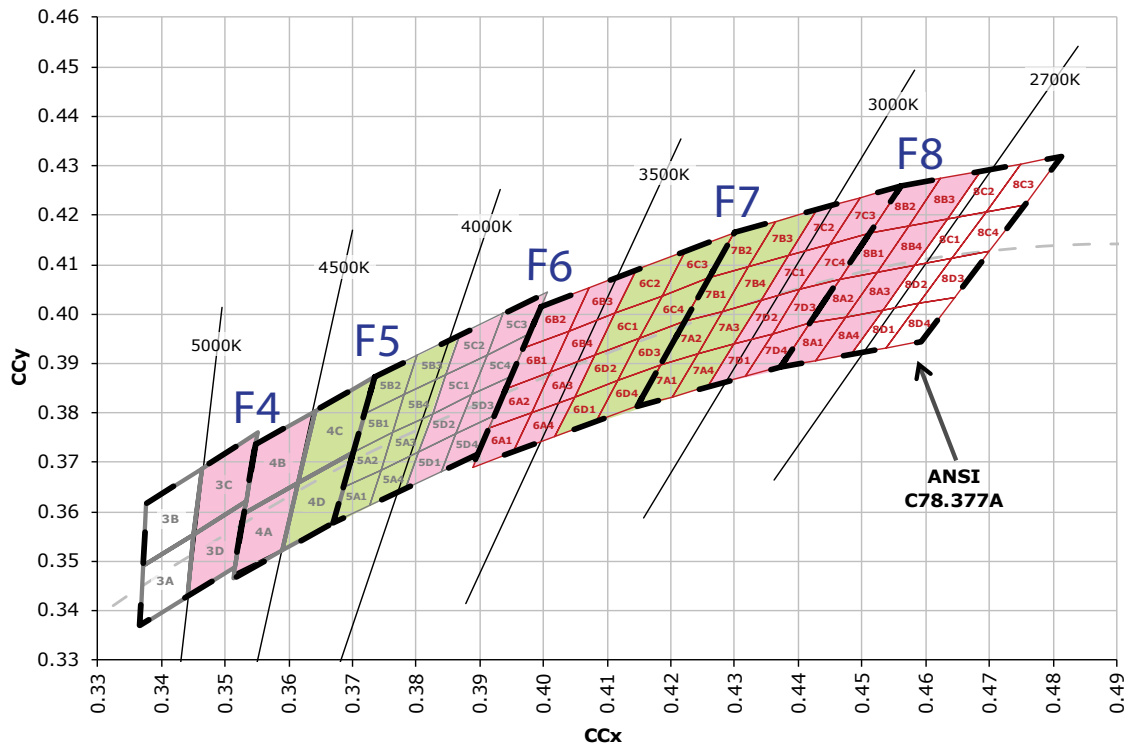
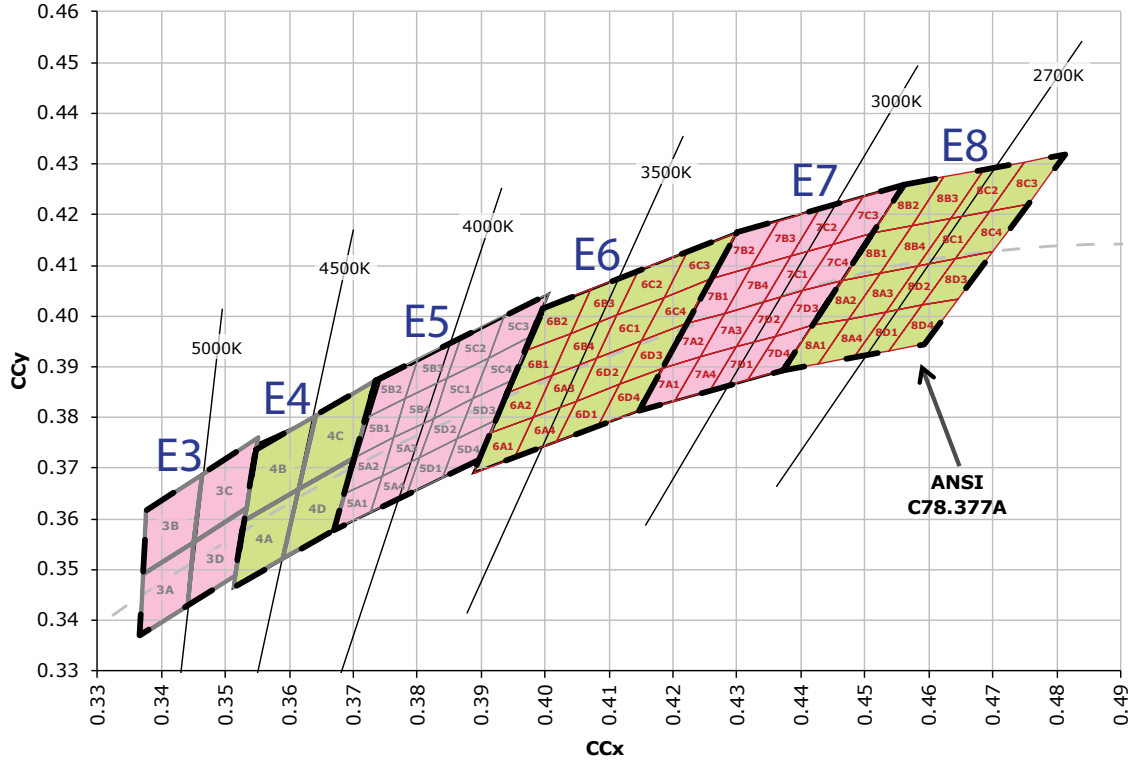

CREE'S STANDARD WARM AND NEUTRAL WHITE KITS PLOTTED ON ANSI STANDARD CHROMATICITY REGIONS - CONTINUED

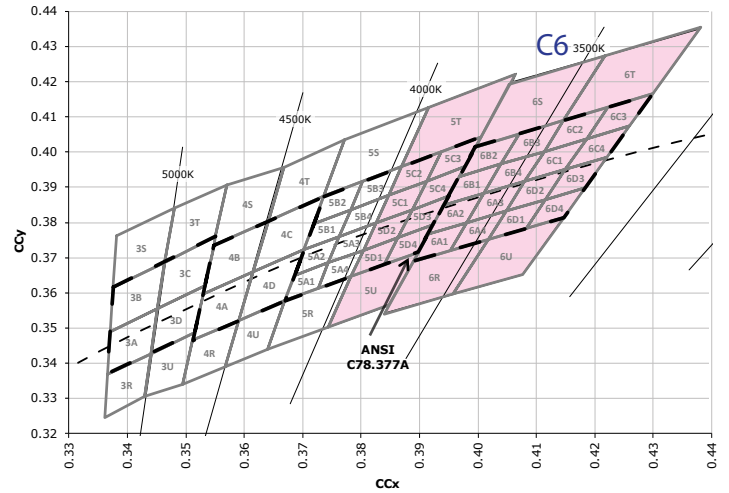
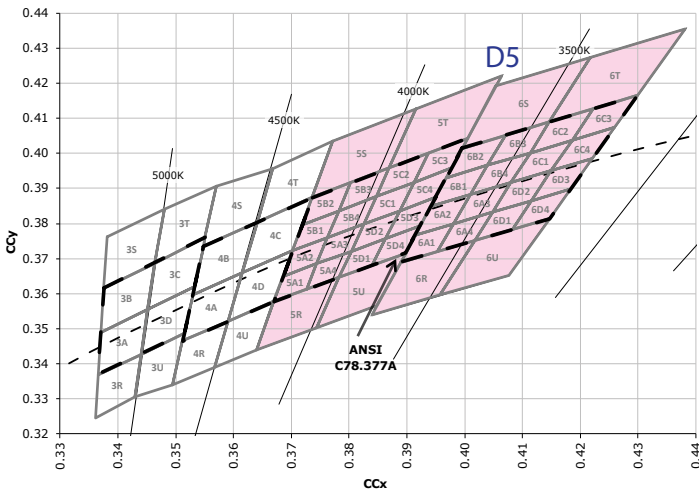
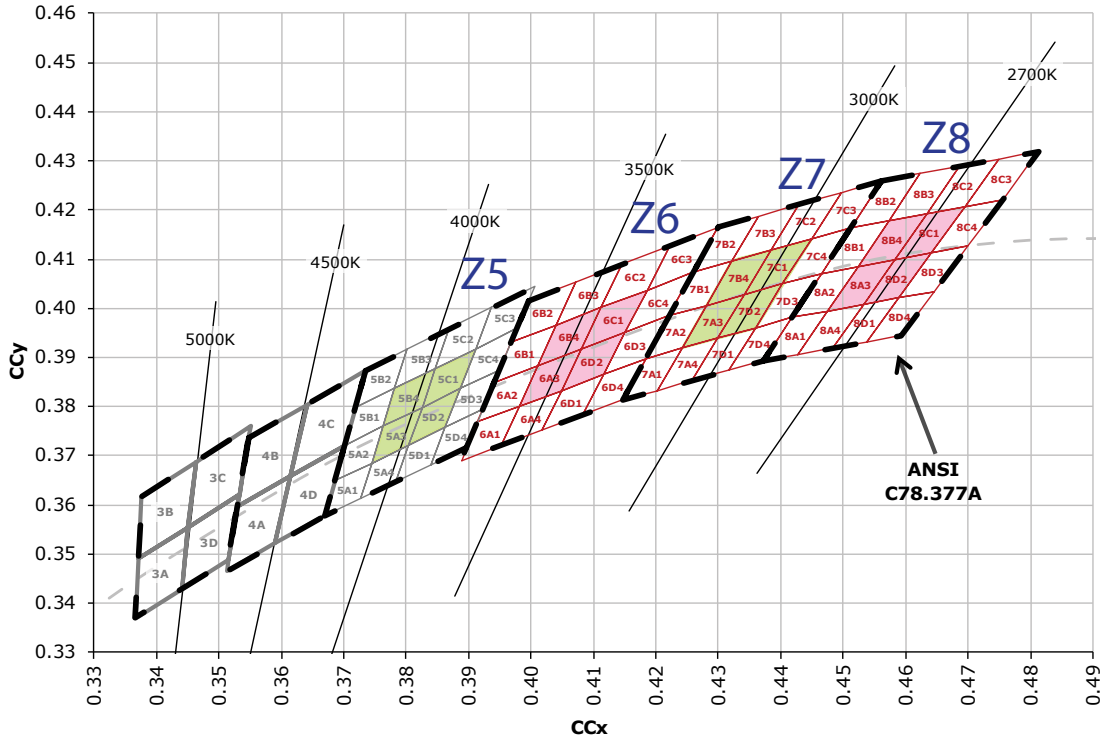

CREE'S 2200 K CCT WHITE KITS PLOTTED ON ANSI STANDARD CHROMATICITY REGIONS

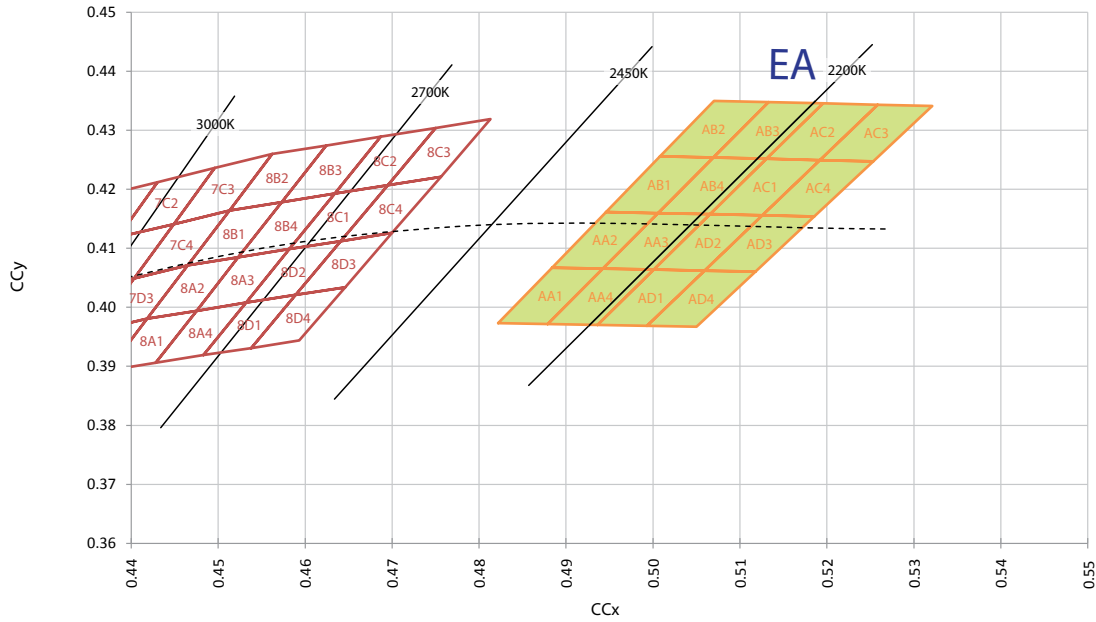

CREE'S PC AMBER KIT PLOTTED ON THE 1931 CIE CURVE

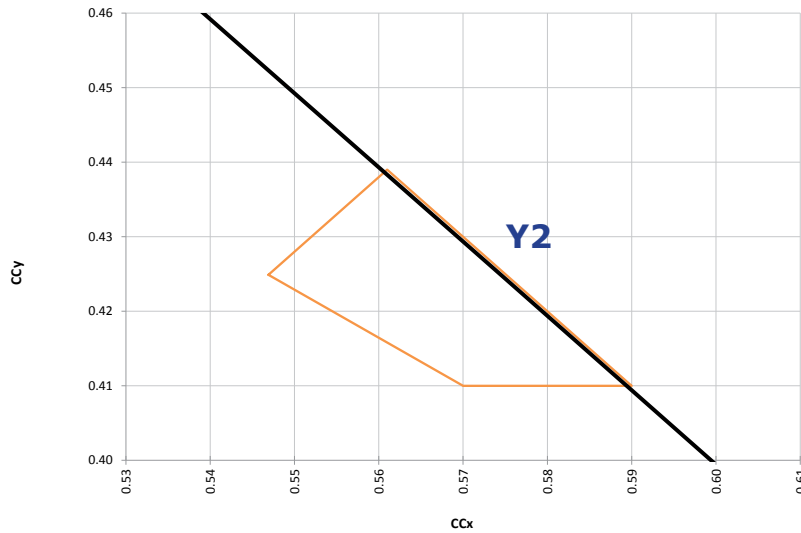

CREE'S STANDARD CHROMATICITY KITS

The following table provides the chromaticity bins associated with chromaticity kits.

Color	CCT	Kit	Chromaticity Bins
Cool White	6200 K	51	0A, 0B, 0C, 0D, 0R, 0S, 0T, 0U, 1A, 1B, 1C, 1D, 1R, 1S, 1T, 1U, 2A, 2B, 2C, 2D, 2R, 2S, 2T, 2U, 3A, 3B, 3R, 3S
	6000 K	53	1A, 1B, 1C, 1D, 1R, 1S, 1T, 1U, 2A, 2B, 2C, 2D, 2R, 2S, 2T, 3A, 3B, 3S
	6200 K	50	1A, 1B, 1C, 1D, 2A, 2B, 2C, 2D
	6500 K	E1	1A, 1B, 1C, 1D
	5700 K	E2	2A, 2B, 2C, 2D
Neutral White	5000 K	E3	3A, 3B, 3C, 3D
	5000 K	C1	3A, 3B, 3C, 3D, 3R, 3S, 3T, 3U, 4A, 4B, 4R, 4S
	4750 K	F4	3C, 3D, 4A, 4B
	4750 K	D1	3A, 3B, 3C, 3D, 3R, 3S, 3T, 3U, 4A, 4B, 4C, 4D, 4R, 4S, 4T, 4U
	4500 K	E4	4A, 4B, 4C, 4D
	4500 K	D2	3C, 3D, 3T, 3U, 4A, 4B, 4C, 4D, 4R, 4S, 4T, 4U, 5A1, 5A2, 5A3, 5A4, 5B1, 5B2, 5B3, 5B4, 5R, 5S
	4500 K	C2	3C, 3D, 3T, 3U, 4A, 4B, 4C, 4D, 4R, 4S, 4T, 4U
	4300 K	C3	4A, 4B, 4C, 4D, 4R, 4S, 4T, 4U, 5A1, 5A2, 5A3, 5A4, 5B1, 5B2, 5B3, 5B4, 5R, 5S
	4300 K	D3	4A, 4B, 4C, 4D, 4R, 4S, 4T, 4U, 5A1, 5A2, 5A3, 5A4, 5B1, 5B2, 5B3, 5B4, 5C1, 5C2, 5C3, 5C4, 5D1, 5D2, 5D3, 5D4, 5R, 5S, 5T, 5U
	4250 K	F5	4C, 4D, 5A1, 5A2, 5A3, 5A4, 5B1, 5B2, 5B3, 5B4
	4100 K	C4	4C, 4D, 4T, 4U, 5A1, 5A2, 5A3, 5A4, 5B1, 5B2, 5B3, 5B4, 5C1, 5C2, 5C3, 5C4, 5D1, 5D2, 5D3, 5D4, 5R, 5S, 5T, 5U
	4000 K	D4	4C, 4D, 4T, 4U, 5A1, 5A2, 5A3, 5A4, 5B1, 5B2, 5B3, 5B4, 5C1, 5C2, 5C3, 5C4, 5D1, 5D2, 5D3, 5D4, 5R, 5S, 5T, 5U, 6A1, 6A2, 6A3, 6A4, 6B1, 6B2, 6B3, 6B4, 6R, 6S
	4000 K	E5	5A1, 5A2, 5A3, 5A4, 5B1, 5B2, 5B3, 5B4, 5C1, 5C2, 5C3, 5C4, 5D1, 5D2, 5D3, 5D4
	4000 K	Z5	5A3, 5B4, 5C1, 5D2
3800 K	C5	5A1, 5A2, 5A3, 5A4, 5B1, 5B2, 5B3, 5B4, 5C1, 5C2, 5C3, 5C4, 5D1, 5D2, 5D3, 5D4, 5R, 5S, 5T, 5U, 6A1, 6A2, 6A3, 6A4, 6B1, 6B2, 6B3, 6B4, 6R, 6S	
Warm White	3750 K	F6	5C1, 5C2, 5C3, 5C4, 5D1, 5D2, 5D3, 5D4, 6A1, 6A2, 6A3, 6A4, 6B1, 6B2, 6B3, 6B4
	3700 K	D5	5A1, 5A2, 5A3, 5A4, 5B1, 5B2, 5B3, 5B4, 5C1, 5C2, 5C3, 5C4, 5D1, 5D2, 5D3, 5D4, 5R, 5S, 5T, 5U, 6A1, 6A2, 6A3, 6A4, 6B1, 6B2, 6B3, 6B4, 6C1, 6C2, 6C3, 6C4, 6D1, 6D2, 6D3, 6D4, 6R, 6S, 6T, 6U
	3600 K	C6	5C1, 5C2, 5C3, 5C4, 5D1, 5D2, 5D3, 5D4, 5T, 5U, 6A1, 6A2, 6A3, 6A4, 6B1, 6B2, 6B3, 6B4, 6C1, 6C2, 6C3, 6C4, 6D1, 6D2, 6D3, 6D4, 6R, 6S, 6T, 6U
	3500 K	E6	6A1, 6A2, 6A3, 6A4, 6B1, 6B2, 6B3, 6B4, 6C1, 6C2, 6C3, 6C4, 6D1, 6D2, 6D3, 6D4
	3500 K	Z6	6A3, 6B4, 6C1, 6D2
	3250 K	F7	6C1, 6C2, 6C3, 6C4, 6D1, 6D2, 6D3, 6D4, 7A1, 7A2, 7A3, 7A4, 7B1, 7B2, 7B3, 7B4
	3000 K	E7	7A1, 7A2, 7A3, 7A4, 7B1, 7B2, 7B3, 7B4, 7C1, 7C2, 7C3, 7C4, 7D1, 7D2, 7D3, 7D4
	3000 K	Z7	7A3, 7B4, 7C1, 7D2
	2850 K	F8	7C1, 7C2, 7C3, 7C4, 7D1, 7D2, 7D3, 7D4, 8A1, 8A2, 8A3, 8A4, 8B1, 8B2, 8B3, 8B4
	2700 K	E8	8A1, 8A2, 8A3, 8A4, 8B1, 8B2, 8B3, 8B4, 8C1, 8C2, 8C3, 8C4, 8D1, 8D2, 8D3, 8D4
	2700 K	Z8	8A3, 8B4, 8C1, 8D2
2200 K	EA	AA1, AA2, AA3, AA4, AB1, AB2, AB3, AB4, AC1, AC2, AC3, AC4, AD1, AD2, AD3, AD4	

The following tables of order codes list flux minimums and chromaticity regions for the various categories of XLamp XP LEDs. For other flux and chromaticity combinations, contact Cree or an authorized distributor.

STANDARD ORDER CODES AND PRE-ANSI BINS (XP-C COOL WHITE, T_j = 25 °C)

XLamp XP-C LED Standard Order Codes - White				
Min. Luminous Flux (lm) @ 350 mA*		Chromaticity Regions		Order Codes
Group	Flux (lm)			
Cool White (5000 K – 10,000 K)				
Q2	87.4	WA, WB, WC, WD, WE, WF, WG, WH, WJ, WK, WM, WN, WP		XPCWHT-L1-0000-00A01
		WC, WD, WF, WG		XPCWHT-L1-0000-00A02
		WC, WD, WF, WG, WH, WJ, WN, WP		XPCWHT-L1-0000-00A03
Q3	93.9	WA, WB, WC, WD, WE, WF, WG, WH, WJ, WK, WM, WN, WP		XPCWHT-L1-0000-00B01
		WC, WD, WF, WG		XPCWHT-L1-0000-00B02
		WC, WD, WF, WG, WH, WJ, WN, WP		XPCWHT-L1-0000-00B03
Q4	100	WA, WB, WC, WD, WE, WF, WG, WH, WJ, WK, WM, WN, WP		XPCWHT-L1-0000-00C01
		WC, WD, WF, WG		XPCWHT-L1-0000-00C02
		WC, WD, WF, WG, WH, WJ, WN, WP		XPCWHT-L1-0000-00C03
Q5	107	WA, WB, WC, WD, WE, WF, WG, WH, WJ, WK, WM, WN, WP		XPCWHT-L1-0000-00D01
		WC, WD, WF, WG		XPCWHT-L1-0000-00D02
		WC, WD, WF, WG, WH, WJ, WN, WP		XPCWHT-L1-0000-00D03

STANDARD ORDER CODES AND BINS (XP-C ANSI COOL WHITE, T_j = 25 °C)

XLamp XP-C LED Standard Order Codes - White				
Chromaticity		Minimum Luminous Flux (lm) @ 350 mA*		Order Codes
Kit	CCT	Code	Flux (lm)	70 CRI Typical
ANSI Cool White (5000 K – 8300 K)				
51	6200 K	Q5	107	XPCWHT-L1-0000-00D51
		Q4	100	XPCWHT-L1-0000-00C51
		Q3	93.9	XPCWHT-L1-0000-00B51
		Q2	87.4	XPCWHT-L1-0000-00A51
53	6000 K	Q5	107	XPCWHT-L1-0000-00D53
		Q4	100	XPCWHT-L1-0000-00C53
		Q3	93.9	XPCWHT-L1-0000-00B53
		Q2	87.4	XPCWHT-L1-0000-00A53
50	6200 K	Q5	107	XPCWHT-L1-0000-00D50
		Q4	100	XPCWHT-L1-0000-00C50
		Q3	93.9	XPCWHT-L1-0000-00B50
		Q2	87.4	XPCWHT-L1-0000-00A50
E1	6500 K	Q5	107	XPCWHT-L1-0000-00DE1
		Q4	100	XPCWHT-L1-0000-00CE1
		Q3	93.9	XPCWHT-L1-0000-00BE1
		Q2	87.4	XPCWHT-L1-0000-00AE1
E2	5700 K	Q5	107	XPCWHT-L1-0000-00DE2
		Q4	100	XPCWHT-L1-0000-00CE2
		Q3	93.9	XPCWHT-L1-0000-00BE2
		Q2	87.4	XPCWHT-L1-0000-00AE2

* Cree XLamp XP Family LED order codes specify only a minimum flux bin and not a maximum. Cree may ship reels in flux bins higher than the minimum specified by the order code without advance notice. Shipments will always adhere to the chromaticity or DWL bin restrictions specified by the order code.

STANDARD ORDER CODES AND BINS (XP-C NEUTRAL WHITE, T_j = 25 °C)

XLamp XP-C LED Standard Kit Codes - White				
Chromaticity		Minimum Luminous Flux (lm) @ 350 mA*		Order Codes
Kit	CCT	Code	Flux (lm)	75 CRI Typical
ANSI Neutral White (3700 K – 5000 K)				
E3	5000 K	Q2	87.4	XPCWHT-L1-0000-00AE3
		P4	80.6	XPCWHT-L1-0000-009E3
		P3	73.9	XPCWHT-L1-0000-008E3
F4	4750 K	Q2	87.4	XPCWHT-L1-0000-00AF4
		P4	80.6	XPCWHT-L1-0000-009F4
		P3	73.9	XPCWHT-L1-0000-008F4
E4	4500 K	Q2	87.4	XPCWHT-L1-0000-00AE4
		P4	80.6	XPCWHT-L1-0000-009E4
		P3	73.9	XPCWHT-L1-0000-008E4
F5	4250 K	Q2	87.4	XPCWHT-L1-0000-00AF5
		P4	80.6	XPCWHT-L1-0000-009F5
		P3	73.9	XPCWHT-L1-0000-008F5
		P2	67.2	XPCWHT-L1-0000-007F5
E5	4000 K	Q2	87.4	XPCWHT-L1-0000-00AE5
		P4	80.6	XPCWHT-L1-0000-009E5
		P3	73.9	XPCWHT-L1-0000-008E5
		P2	67.2	XPCWHT-L1-0000-007E5

* Cree XLamp XP Family LED order codes specify only a minimum flux bin and not a maximum. Cree may ship reels in flux bins higher than the minimum specified by the order code without advance notice. Shipments will always adhere to the chromaticity or DWL bin restrictions specified by the order code.

STANDARD ORDER CODES AND BINS (XP-C WARM WHITE, $T_j = 25\text{ }^\circ\text{C}$)

XLamp XP-C LED Standard Kit Codes - White				
Chromaticity		Minimum Luminous Flux (lm) @ 350 mA*		Order Codes
Kit	CCT	Code	Flux (lm)	80 CRI Typical
ANSI Warm White (2700 K - 3750 K)				
F6	3750 K	P4	80.6	XPCWHT-L1-0000-009F6
		P3	73.9	XPCWHT-L1-0000-008F6
		P2	67.2	XPCWHT-L1-0000-007F6
E6	3500 K	P4	80.6	XPCWHT-L1-0000-009E6
		P3	73.9	XPCWHT-L1-0000-008E6
		P2	67.2	XPCWHT-L1-0000-007E6
F7	3250 K	P3	73.9	XPCWHT-L1-0000-008F7
		P2	67.2	XPCWHT-L1-0000-007F7
		N4	62	XPCWHT-L1-0000-006F7
E7	3000 K	P3	73.9	XPCWHT-L1-0000-008E7
		P2	67.2	XPCWHT-L1-0000-007E7
		N4	62	XPCWHT-L1-0000-006E7
F8	2850 K	P2	67.2	XPCWHT-L1-0000-007F8
		N4	62	XPCWHT-L1-0000-006F8
		N3	56.8	XPCWHT-L1-0000-005F8
E8	2700 K	P2	67.2	XPCWHT-L1-0000-007E8
		N4	62	XPCWHT-L1-0000-006E8
		N3	56.8	XPCWHT-L1-0000-005E8

STANDARD ORDER CODES AND BINS (XP-C COLOR, $T_j = 25\text{ }^\circ\text{C}$)

XLamp XP-C LED Standard Order Codes - Royal Blue								
Color	Min. Radiant Flux (mW) @ 350 mA*		Calculated Min. Radiant Flux (mW) @ 125 mA**	Dominant Wavelength (nm)				Order Codes
	Group	Flux (mW)		Min.		Max.		
			Group	DWL (nm)	Group	DWL (nm)		
Royal Blue	12	250	104	D3	450	D5	465	XPCROY-L1-0000-00701
				D3	450	D4	460	XPCROY-L1-0000-00702
				D4	455	D5	465	XPCROY-L1-0000-00703
	13	300	124	D3	450	D5	465	XPCROY-L1-0000-00801
				D3	450	D4	460	XPCROY-L1-0000-00802
				D4	455	D5	465	XPCROY-L1-0000-00803
	14	350	145	D3	450	D5	465	XPCROY-L1-0000-00901
				D3	450	D4	460	XPCROY-L1-0000-00902

** Calculated values for reference only

* Cree XLamp XP Family LED order codes specify only a minimum flux bin and not a maximum. Cree may ship reels in flux bins higher than the minimum specified by the order code without advance notice. Shipments will always adhere to the chromaticity or DWL bin restrictions specified by the order code.

STANDARD ORDER CODES AND BINS (XP-C COLOR, T_j = 25 °C) - CONTINUED

XLamp XP-C LED Standard Order Codes - Color								
Color	Min. Luminous Flux (lm) @ 350 mA*		Calculated Min. Luminous Flux (lm) @ 125 mA**	Dominant Wavelength (nm)				Order Codes
	Group	Flux (lm)		Min.		Max.		
			Group	DWL (nm)	Group	DWL (nm)		
Blue	J	23.5	10.8	B3	465	B6	485	XPCBLU-L1-0000-00W01
				B3	465	B5	480	XPCBLU-L1-0000-00W02
				B4	470	B5	480	XPCBLU-L1-0000-00W05
	K2	30.6	13.8	B3	465	B6	485	XPCBLU-L1-0000-00Y01
				B3	465	B5	480	XPCBLU-L1-0000-00Y02
				B4	470	B5	480	XPCBLU-L1-0000-00Y05
Green	N3	56.8	28.2	G2	520	G4	535	XPCGRN-L1-0000-00501
				G2	520	G3	530	XPCGRN-L1-0000-00502
				G3	525	G4	535	XPCGRN-L1-0000-00503
	N4	62.0	30.8	G2	520	G4	535	XPCGRN-L1-0000-00601
				G2	520	G3	530	XPCGRN-L1-0000-00602
				G3	525	G4	535	XPCGRN-L1-0000-00603
	P2	67.2	33.3	G2	520	G4	535	XPCGRN-L1-0000-00701
				G2	520	G3	530	XPCGRN-L1-0000-00702
				G3	525	G4	535	XPCGRN-L1-0000-00703
	P3	73.9	36.7	G2	520	G4	535	XPCGRN-L1-0000-00801
				G2	520	G3	530	XPCGRN-L1-0000-00802
				G3	525	G4	535	XPCGRN-L1-0000-00803
Amber	M2	39.8	14.9	A2	585	A3	595	XPCAMB-L1-0000-00201
	M3	45.7	17.1	A2	585	A3	595	XPCAMB-L1-0000-00301
	N2	51.7	19.4	A2	585	A3	595	XPCAMB-L1-0000-00401
	N3	56.8	21.3	A2	585	A3	595	XPCAMB-L1-0000-00501
Red-Orange	N2	51.7	19.8	O3	610	O4	620	XPCRDO-L1-0000-00401
	N3	56.8	21.7	O3	610	O4	620	XPCRDO-L1-0000-00501
	N4	62.0	23.7	O3	610	O4	620	XPCRDO-L1-0000-00601
	P2	67.2	25.7	O3	610	O4	620	XPCRDO-L1-0000-00701
Red	M2	39.8	15.2	R2	620	R3	630	XPCRED-L1-0000-00201
	M3	45.7	17.5	R2	620	R3	630	XPCRED-L1-0000-00301
	N2	51.7	19.7	R2	620	R3	630	XPCRED-L1-0000-00401
	N3	56.8	21.7	R2	620	R3	630	XPCRED-L1-0000-00501

** Calculated values for reference only

* Cree XLamp XP Family LED order codes specify only a minimum flux bin and not a maximum. Cree may ship reels in flux bins higher than the minimum specified by the order code without advance notice. Shipments will always adhere to the chromaticity or DWL bin restrictions specified by the order code.

STANDARD ORDER CODES AND BINS (XP-E COOL WHITE, T_j = 25 °C)

XLamp XP-E LED Standard Order Codes - White				
Minimum Luminous Flux (lm) @ 350 mA*		Chromaticity Regions		Order Codes
Group	Flux (lm)			70 CRI Typical
Cool White (5000 K - 10,000 K)				
Q4	100	WA, WB, WC, WD, WE, WF, WG, WH, WJ, WK, WM, WN, WP		XPEWHT-L1-0000-00C01
		WC, WD, WF, WG		XPEWHT-L1-0000-00C02
		WC, WD, WF, WG, WH, WJ, WN, WP		XPEWHT-L1-0000-00C03
Q5	107	WA, WB, WC, WD, WE, WF, WG, WH, WJ, WK, WM, WN, WP		XPEWHT-L1-0000-00D01
		WC, WD, WF, WG		XPEWHT-L1-0000-00D02
		WC, WD, WF, WG, WH, WJ, WN, WP		XPEWHT-L1-0000-00D03
R2	114	WA, WB, WC, WD, WE, WF, WG, WH, WJ, WK, WM, WN, WP		XPEWHT-L1-0000-00E01
		WC, WD, WF, WG		XPEWHT-L1-0000-00E02
		WC, WD, WF, WG, WH, WJ, WN, WP		XPEWHT-L1-0000-00E03
R3	122	WA, WB, WC, WD, WE, WF, WG, WH, WJ, WK, WM, WN, WP		XPEWHT-L1-0000-00F01
		WC, WD, WF, WG		XPEWHT-L1-0000-00F02
		WC, WD, WF, WG, WH, WJ, WN, WP		XPEWHT-L1-0000-00F03

STANDARD ORDER CODES AND BINS (XP-E ANSI COOL WHITE, T_j = 25 °C)

XLamp XP-E LED Standard Order Codes - White				
Chromaticity		Minimum Luminous Flux (lm) @ 350 mA*		Order Codes
Kit	CCT	Code	Flux (lm)	70 CRI Typical
ANSI Cool White (5000 K - 8300 K)				
51	6200 K	R3	122	XPEWHT-L1-0000-00F51
		R2	114	XPEWHT-L1-0000-00E51
		Q5	107	XPEWHT-L1-0000-00D51
		Q4	100	XPEWHT-L1-0000-00C51
53	6000 K	R3	122	XPEWHT-L1-0000-00F53
		R2	114	XPEWHT-L1-0000-00E53
		Q5	107	XPEWHT-L1-0000-00D53
		Q4	100	XPEWHT-L1-0000-00C53
50	6200 K	R3	122	XPEWHT-L1-0000-00F50
		R2	114	XPEWHT-L1-0000-00E50
		Q5	107	XPEWHT-L1-0000-00D50
		Q4	100	XPEWHT-L1-0000-00C50
E1	6500 K	R3	122	XPEWHT-L1-0000-00FE1
		R2	114	XPEWHT-L1-0000-00EE1
		Q5	107	XPEWHT-L1-0000-00DE1
		Q4	100	XPEWHT-L1-0000-00CE1
E2	5700 K	R3	122	XPEWHT-L1-0000-00FE2
		R2	114	XPEWHT-L1-0000-00EE2
		Q5	107	XPEWHT-L1-0000-00DE2
		Q4	100	XPEWHT-L1-0000-00CE2

* Cree XLamp XP Family LED order codes specify only a minimum flux bin and not a maximum. Cree may ship reels in flux bins higher than the minimum specified by the order code without advance notice. Shipments will always adhere to the chromaticity or DWL bin restrictions specified by the order code.

STANDARD ORDER CODES AND BINS (XP-E NEUTRAL WHITE, OUTDOOR WHITE, T_j = 25 °C)

XLamp XP-E LED Standard Kit Codes - White						
Chromaticity		Minimum Luminous Flux (lm) @ 350 mA*		Order Codes		
Kit	CCT	Code	Flux (lm)	70 CRI Typical	75 CRI Typical	80 CRI Minimum
ANSI Neutral White (3700 K – 5000 K)						
E3	5000 K	Q5	107		XPEWHT-L1-0000-00DE3	
		Q4	100		XPEWHT-L1-0000-00CE3	
		Q3	93.9		XPEWHT-L1-0000-00BE3	
C1	5000 K	R3	122	XPEWHT-01-0000-00FC1		
		R2	114	XPEWHT-01-0000-00EC1		
		Q5	107	XPEWHT-01-0000-00DC1		
		Q4	100	XPEWHT-01-0000-00CC1		
F4	4750 K	Q5	107		XPEWHT-L1-0000-00DF4	
		Q4	100		XPEWHT-L1-0000-00CF4	
		Q3	93.9		XPEWHT-L1-0000-00BF4	
D1	4750 K	R3	122	XPEWHT-01-0000-00FD1		
		R2	114	XPEWHT-01-0000-00ED1		
		Q5	107	XPEWHT-01-0000-00DD1		
		Q4	100	XPEWHT-01-0000-00CD1		
E4	4500 K	Q5	107		XPEWHT-L1-0000-00DE4	
		Q4	100		XPEWHT-L1-0000-00CE4	
		Q3	93.9		XPEWHT-L1-0000-00BE4	
D2	4500 K	R3	122	XPEWHT-01-0000-00FD2		
		R2	114	XPEWHT-01-0000-00ED2		
		Q5	107	XPEWHT-01-0000-00DD2		
		Q4	100	XPEWHT-01-0000-00CD2		
C2	4500 K	R3	122	XPEWHT-01-0000-00FC2		
		R2	114	XPEWHT-01-0000-00EC2		
		Q5	107	XPEWHT-01-0000-00DC2		
		Q4	100	XPEWHT-01-0000-00CC2		
C3	4300 K	R3	122	XPEWHT-01-0000-00FC3		
		R2	114	XPEWHT-01-0000-00EC3		
		Q5	107	XPEWHT-01-0000-00DC3		
		Q4	100	XPEWHT-01-0000-00CC3		
F5	4250 K	Q5	107		XPEWHT-L1-0000-00DF5	
		Q4	100		XPEWHT-L1-0000-00CF5	
		Q3	93.9		XPEWHT-L1-0000-00BF5	
		Q2	87.4		XPEWHT-L1-0000-00AF5	
E5	4000 K	Q5	107		XPEWHT-L1-0000-00DE5	
		Q4	100		XPEWHT-L1-0000-00CE5	XPEWHT-H1-0000-00CE5
		Q3	93.9		XPEWHT-L1-0000-00BE5	XPEWHT-H1-0000-00BE5
		Q2	87.4		XPEWHT-L1-0000-00AE5	XPEWHT-H1-0000-00AE5
Z5	4000 K	Q4	100		XPEWHT-L1-0000-00CZ5	
		Q3	93.9		XPEWHT-L1-0000-00BZ5	XPEWHT-H1-0000-00BZ5
		Q2	87.4		XPEWHT-L1-0000-00AZ5	XPEWHT-H1-0000-00AZ5

* Cree XLamp XP Family LED order codes specify only a minimum flux bin and not a maximum. Cree may ship reels in flux bins higher than the minimum specified by the order code without advance notice. Shipments will always adhere to the chromaticity or DWL bin restrictions specified by the order code.

STANDARD ORDER CODES AND BINS (XP-E WARM WHITE, T_j = 25 °C)

XLamp XP-E LED Standard Kit Codes - White							
Chromaticity		Minimum Luminous Flux (lm) @ 350 mA*		Order Codes			
Kit	CCT	Code	Flux (lm)	80 CRI Typical	80 CRI Minimum	85 CRI Minimum	90 CRI Minimum
ANSI Warm White (2700 K - 3750 K)							
F6	3750 K	Q4	100	XPEWHT-L1-0000-00CF6			
		Q3	93.9	XPEWHT-L1-0000-00BF6	XPEWHT-H1-0000-00BF6		
		Q2	87.4	XPEWHT-L1-0000-00AF6	XPEWHT-H1-0000-00AF6		
		P4	80.6	XPEWHT-L1-0000-009F6	XPEWHT-H1-0000-009F6		
E6	3500 K	Q4	100	XPEWHT-L1-0000-00CE6			
		Q3	93.9	XPEWHT-L1-0000-00BE6	XPEWHT-H1-0000-00BE6		
		Q2	87.4	XPEWHT-L1-0000-00AE6	XPEWHT-H1-0000-00AE6		
		P4	80.6	XPEWHT-L1-0000-009E6	XPEWHT-H1-0000-009E6		
Z6	3500 K	Q3	93.9	XPEWHT-L1-0000-00BZ6			
		Q2	87.4	XPEWHT-L1-0000-00AZ6	XPEWHT-H1-0000-00AZ6		
		P4	80.6	XPEWHT-L1-0000-009Z6	XPEWHT-H1-0000-009Z6		
F7	3250 K	Q3	93.9	XPEWHT-L1-0000-00BF7			
		Q2	87.4	XPEWHT-L1-0000-00AF7	XPEWHT-H1-0000-00AF7		
		P4	80.6	XPEWHT-L1-0000-009F7	XPEWHT-H1-0000-009F7		
E7	3000 K	Q3	93.9	XPEWHT-L1-0000-00BE7			
		Q2	87.4	XPEWHT-L1-0000-00AE7	XPEWHT-H1-0000-00AE7		
		P4	80.6	XPEWHT-L1-0000-009E7	XPEWHT-H1-0000-009E7	XPEWHT-P1-0000-009E7	
		P3	73.9			XPEWHT-P1-0000-008E7	XPEWHT-U1-0000-008E7
		P2	67.2			XPEWHT-P1-0000-007E7	XPEWHT-U1-0000-007E7
		N4	62			XPEWHT-P1-0000-006E7	XPEWHT-U1-0000-006E7
Z7	3000 K	Q2	87.4	XPEWHT-L1-0000-00AZ7	XPEWHT-H1-0000-00AZ7		
		P4	80.6	XPEWHT-L1-0000-009Z7	XPEWHT-H1-0000-009Z7		
		P3	73.9			XPEWHT-P1-0000-008Z7	
		P2	67.2			XPEWHT-P1-0000-007Z7	XPEWHT-U1-0000-007Z7
		N4	62			XPEWHT-P1-0000-006Z7	XPEWHT-U1-0000-006Z7
F8	2850 K	Q2	87.4	XPEWHT-L1-0000-00AF8			
		P4	80.6	XPEWHT-L1-0000-009F8	XPEWHT-H1-0000-009F8		
		P3	73.9	XPEWHT-L1-0000-008F8	XPEWHT-H1-0000-008F8	XPEWHT-P1-0000-008F8	
		P2	67.2			XPEWHT-P1-0000-007F8	XPEWHT-U1-0000-007F8
		N4	62			XPEWHT-P1-0000-006F8	XPEWHT-U1-0000-006F8
		N3	56.8			XPEWHT-P1-0000-005F8	XPEWHT-U1-0000-005F8
E8	2700 K	Q2	87.4	XPEWHT-L1-0000-00AE8			
		P4	80.6	XPEWHT-L1-0000-009E8	XPEWHT-H1-0000-009E8		
		P3	73.9	XPEWHT-L1-0000-008E8	XPEWHT-H1-0000-008E8	XPEWHT-P1-0000-008E8	
		P2	67.2			XPEWHT-P1-0000-007E8	XPEWHT-U1-0000-007E8
		N4	62			XPEWHT-P1-0000-006E8	XPEWHT-U1-0000-006E8
		N3	56.8			XPEWHT-P1-0000-005E8	XPEWHT-U1-0000-005E8
Z8	2700 K	P4	80.6	XPEWHT-L1-0000-009Z8	XPEWHT-H1-0000-009Z8		
		P3	73.9	XPEWHT-L1-0000-008Z8	XPEWHT-H1-0000-008Z8		
		P2	67.2			XPEWHT-P1-0000-007Z8	
		N4	62			XPEWHT-P1-0000-006Z8	XPEWHT-U1-0000-006Z8
		N3	56.8			XPEWHT-P1-0000-005Z8	XPEWHT-U1-0000-005Z8

* Cree XLamp XP Family LED order codes specify only a minimum flux bin and not a maximum. Cree may ship reels in flux bins higher than the minimum specified by the order code without advance notice. Shipments will always adhere to the chromaticity or DWL bin restrictions specified by the order code.

STANDARD ORDER CODES AND BINS (XP-E COLOR, T_j = 25 °C)

XLamp XP-E LED Standard Order Codes - Royal Blue							
Color	Min. Radiant Flux (mW) @ 350 mA*		Dominant Wavelength (nm)				Order Codes
	Group	Flux (mW)	Min.		Max.		
			Group	DWL (nm)	Group	DWL (nm)	
Royal Blue	14	350	D3	450	D5	465	XPEROY-L1-0000-00901
			D3	450	D4	460	XPEROY-L1-0000-00902
			D4	455	D5	465	XPEROY-L1-0000-00903
	15	425	D3	450	D5	465	XPEROY-L1-0000-00A01
			D3	450	D4	460	XPEROY-L1-0000-00A02
			D4	455	D5	465	XPEROY-L1-0000-00A03
	16	500	D3	450	D5	465	XPEROY-L1-0000-00B01
			D3	450	D4	460	XPEROY-L1-0000-00B02

XLamp XP-E LED Standard Order Codes - Color							
Color	Min. Luminous Flux (lm) @ 350 mA*		Dominant Wavelength (nm)				Order Codes
	Group	Flux (lm)	Min.		Max.		
			Group	DWL (nm)	Group	DWL (nm)	
Blue	K2	30.6	B3	465	B6	485	XPEBLU-L1-0000-00Y01
			B3	465	B5	480	XPEBLU-L1-0000-00Y02
			B4	470	B5	480	XPEBLU-L1-0000-00Y05
	K3	35.2	B3	465	B6	485	XPEBLU-L1-0000-00Z01
			B3	465	B5	480	XPEBLU-L1-0000-00Z02
			B4	470	B5	480	XPEBLU-L1-0000-00Z05
	M2	39.8	B3	465	B6	485	XPEBLU-L1-0000-00201
			B3	465	B5	480	XPEBLU-L1-0000-00202
			B4	470	B5	480	XPEBLU-L1-0000-00205

* Cree XLamp XP Family LED order codes specify only a minimum flux bin and not a maximum. Cree may ship reels in flux bins higher than the minimum specified by the order code without advance notice. Shipments will always adhere to the chromaticity or DWL bin restrictions specified by the order code.

STANDARD ORDER CODES AND BINS (XP-E COLOR, T_j = 25 °C) - CONTINUED

XLamp XP-E LED Standard Order Codes - Color								
Color	Min. Luminous Flux (lm)@ 350 mA*		Dominant Wavelength (nm)				Order Codes	
	Group	Flux (lm)	Min.		Max.			
			Group	DWL (nm)	Group	DWL (nm)		
Green	P4	80.6	G2	520	G4	535	XPEGRN-L1-0000-00901	
			G2	520	G3	530	XPEGRN-L1-0000-00902	
			G3	525	G4	535	XPEGRN-L1-0000-00903	
	Q2	87.4	G2	520	G4	535	XPEGRN-L1-0000-00A01	
			G2	520	G3	530	XPEGRN-L1-0000-00A02	
			G3	525	G4	535	XPEGRN-L1-0000-00A03	
	Q3	93.9	G2	520	G4	535	XPEGRN-L1-0000-00B01	
			G2	520	G3	530	XPEGRN-L1-0000-00B02	
			G3	525	G4	535	XPEGRN-L1-0000-00B03	
	Q4	100	G2	520	G4	535	XPEGRN-L1-0000-00C01	
			G2	520	G3	530	XPEGRN-L1-0000-00C02	
			G3	525	G4	535	XPEGRN-L1-0000-00C03	
	Q5	107	G2	520	G4	535	XPEGRN-L1-0000-00D01	
			G2	520	G3	530	XPEGRN-L1-0000-00D02	
			G3	525	G4	535	XPEGRN-L1-0000-00D03	
	R2	114	G2	520	G4	535	XPEGRN-L1-0000-00E01	
			G2	520	G3	530	XPEGRN-L1-0000-00E02	
			G3	525	G4	535	XPEGRN-L1-0000-00E03	
	Amber	M3	45.7	A2	585	A3	595	XPEAMB-L1-0000-00301
		N2	51.7	A2	585	A3	595	XPEAMB-L1-0000-00401
		N3	56.8	A2	585	A3	595	XPEAMB-L1-0000-00501
N4		62.0	A2	585	A3	595	XPEAMB-L1-0000-00601	
P2		67.2	A2	585	A3	595	XPEAMB-L1-0000-00701	
P3		73.9	A2	585	A3	595	XPEAMB-L1-0000-00801	
P4		80.6	A2	585	A3	595	XPEAMB-L1-0000-00901	
Red-Orange	N3	56.8	O3	610	O4	620	XPERDO-L1-0000-00501	
	N4	62.0	O3	610	O4	620	XPERDO-L1-0000-00601	
	P2	67.2	O3	610	O4	620	XPERDO-L1-0000-00701	
	P3	73.9	O3	610	O4	620	XPERDO-L1-0000-00801	
	P4	80.6	O3	610	O4	620	XPERDO-L1-0000-00901	
	Q2	87.4	O3	610	O4	620	XPERDO-L1-0000-00A01	
Red	M3	45.7	R2	620	R3	630	XPERED-L1-0000-00301	
	N2	51.7	R2	620	R3	630	XPERED-L1-0000-00401	
	N3	56.8	R2	620	R3	630	XPERED-L1-0000-00501	
	N4	62	R2	620	R3	630	XPERED-L1-0000-00601	
	P2	67.2	R2	620	R3	630	XPERED-L1-0000-00701	
	P3	73.9	R2	620	R3	630	XPERED-L1-0000-00801	

* Cree XLamp XP Family LED order codes specify only a minimum flux bin and not a maximum. Cree may ship reels in flux bins higher than the minimum specified by the order code without advance notice. Shipments will always adhere to the chromaticity or DWL bin restrictions specified by the order code.

STANDARD ORDER CODES AND BINS (XP-E COLOR, T_j = 25 °C) - CONTINUED

XLamp XP-E LED Standard Order Codes - Color							
Color	Min. Radiant Flux (mW) @ 350 mA*		Peak Wavelength (nm)				Order Codes
			Min.		Max.		
	Group	Flux (mW)	Group	PWL (nm)	Group	PWL (nm)	
Photo Red	13	300	P2	650	P5	670	XPEPHR-L1-0000-00801
	14	350	P2	650	P5	670	XPEPHR-L1-0000-00901

STANDARD ORDER CODES AND BINS (XP-E2 ANSI COOL WHITE, T_j = 85 °C)

XLamp XP-E2 LED Standard Order Codes - White				
Chromaticity		Minimum Luminous Flux (lm) @ 350 mA*		Order Codes
Kit	CCT	Code	Flux (lm)	70 CRI Typical
ANSI Cool White (5000 K – 8300 K)				
51	6200 K	R3	122	XPEBWT-L1-0000-00F51
		R2	114	XPEBWT-L1-0000-00E51
		Q5	107	XPEBWT-L1-0000-00D51
		Q4	100	XPEBWT-L1-0000-00C51
53	6000 K	R3	122	XPEBWT-L1-0000-00F53
		R2	114	XPEBWT-L1-0000-00E53
		Q5	107	XPEBWT-L1-0000-00D53
		Q4	100	XPEBWT-L1-0000-00C53
50	6200 K	R3	122	XPEBWT-L1-0000-00F50
		R2	114	XPEBWT-L1-0000-00E50
		Q5	107	XPEBWT-L1-0000-00D50
		Q4	100	XPEBWT-L1-0000-00C50
E1	6500 K	R3	122	XPEBWT-L1-0000-00FE1
		R2	114	XPEBWT-L1-0000-00EE1
		Q5	107	XPEBWT-L1-0000-00DE1
		Q4	100	XPEBWT-L1-0000-00CE1
E2	5700 K	R3	122	XPEBWT-L1-0000-00FE2
		R2	114	XPEBWT-L1-0000-00EE2
		Q5	107	XPEBWT-L1-0000-00DE2
		Q4	100	XPEBWT-L1-0000-00CE2

* Cree XLamp XP Family LED order codes specify only a minimum flux bin and not a maximum. Cree may ship reels in flux bins higher than the minimum specified by the order code without advance notice. Shipments will always adhere to the chromaticity or DWL bin restrictions specified by the order code.

STANDARD ORDER CODES AND BINS (XP-E2 NEUTRAL WHITE, OUTDOOR WHITE, T_j = 85 °C)

XLamp XP-E2 LED Standard Kit Codes - White						
Chromaticity		Minimum Luminous Flux (lm) @ 350 mA*		Order Codes		
Kit	CCT	Code	Flux (lm)	70 CRI Typical	75 CRI Typical	80 CRI Minimum
ANSI Neutral White (3700 K – 5000 K)						
E3	5000 K	R2	114		XPEBWT-L1-0000-00EE3	
		Q5	107		XPEBWT-L1-0000-00DE3	
		Q4	100		XPEBWT-L1-0000-00CE3	
C1	5000 K	R3	122	XPEBWT-01-0000-00FC1		
		R2	114	XPEBWT-01-0000-00EC1		
		Q5	107	XPEBWT-01-0000-00DC1		
		Q4	100	XPEBWT-01-0000-00CC1		
F4	4750 K	R2	114		XPEBWT-L1-0000-00EF4	
		Q5	107		XPEBWT-L1-0000-00DF4	
		Q4	100		XPEBWT-L1-0000-00CF4	
D1	4750 K	R3	122	XPEBWT-01-0000-00FD1		
		R2	114	XPEBWT-01-0000-00ED1		
		Q5	107	XPEBWT-01-0000-00DD1		
		Q4	100	XPEBWT-01-0000-00CD1		
E4	4500 K	R2	114		XPEBWT-L1-0000-00EE4	
		Q5	107		XPEBWT-L1-0000-00DE4	
		Q4	100		XPEBWT-L1-0000-00CE4	
D2	4500 K	R3	122	XPEBWT-01-0000-00FD2		
		R2	114	XPEBWT-01-0000-00ED2		
		Q5	107	XPEBWT-01-0000-00DD2		
		Q4	100	XPEBWT-01-0000-00CD2		
C2	4500 K	R3	122	XPEBWT-01-0000-00FC2		
		R2	114	XPEBWT-01-0000-00EC2		
		Q5	107	XPEBWT-01-0000-00DC2		
		Q4	100	XPEBWT-01-0000-00CC2		
C3	4300 K	R3	122	XPEBWT-01-0000-00FC3		
		R2	114	XPEBWT-01-0000-00EC3		
		Q5	107	XPEBWT-01-0000-00DC3		
		Q4	100	XPEBWT-01-0000-00CC3		
F5	4250 K	R2	114		XPEBWT-L1-0000-00EF5	
		Q5	107		XPEBWT-L1-0000-00DF5	
		Q4	100		XPEBWT-L1-0000-00CF5	
		Q3	93.9		XPEBWT-L1-0000-00BF5	
E5	4000 K	R2	114		XPEBWT-L1-0000-00EE5	
		Q5	107		XPEBWT-L1-0000-00DE5	XPEBWT-H1-0000-00DE5
		Q4	100		XPEBWT-L1-0000-00CE5	XPEBWT-H1-0000-00CE5
		Q3	93.9		XPEBWT-L1-0000-00BE5	XPEBWT-H1-0000-00BE5
Z5	4000 K	Q5	107		XPEBWT-L1-0000-00DZ5	
		Q4	100		XPEBWT-L1-0000-00CZ5	XPEBWT-H1-0000-00CZ5
		Q3	93.9		XPEBWT-L1-0000-00BZ5	XPEBWT-H1-0000-00BZ5

* Cree XLamp XP Family LED order codes specify only a minimum flux bin and not a maximum. Cree may ship reels in flux bins higher than the minimum specified by the order code without advance notice. Shipments will always adhere to the chromaticity or DWL bin restrictions specified by the order code.

STANDARD ORDER CODES AND BINS (XP-E2 WARM WHITE, T_j = 85 °C)

XLamp XP-E2 LED Standard Kit Codes - White							
Chromaticity		Minimum Luminous Flux (lm) @ 350 mA*		Order Codes			
Kit	CCT	Code	Flux (lm)	80 CRI Typical	80 CRI Minimum	85 CRI Minimum	90 CRI Minimum
ANSI Warm White (2700 K - 3750 K)							
F6	3750 K	Q5	107	XPEBWT-L1-0000-00DF6			
		Q4	100	XPEBWT-L1-0000-00CF6	XPEBWT-H1-0000-00CF6		
		Q3	93.9	XPEBWT-L1-0000-00BF6	XPEBWT-H1-0000-00BF6		
		Q2	87.4	XPEBWT-L1-0000-00AF6	XPEBWT-H1-0000-00AF6		
E6	3500 K	Q5	107	XPEBWT-L1-0000-00DE6			
		Q4	100	XPEBWT-L1-0000-00CE6	XPEBWT-H1-0000-00CE6		
		Q3	93.9	XPEBWT-L1-0000-00BE6	XPEBWT-H1-0000-00BE6		
		Q2	87.4	XPEBWT-L1-0000-00AE6	XPEBWT-H1-0000-00AE6		
Z6	3500 K	Q4	100	XPEBWT-L1-0000-00CZ6			
		Q3	93.9	XPEBWT-L1-0000-00BZ6	XPEBWT-H1-0000-00BZ6		
		Q2	87.4	XPEBWT-L1-0000-00AZ6	XPEBWT-H1-0000-00AZ6		
F7	3250 K	Q4	100	XPEBWT-L1-0000-00CF7			
		Q3	93.9	XPEBWT-L1-0000-00BF7	XPEBWT-H1-0000-00BF7		
		Q2	87.4	XPEBWT-L1-0000-00AF7	XPEBWT-H1-0000-00AF7		
E7	3000 K	Q4	100	XPEBWT-L1-0000-00CE7			
		Q3	93.9	XPEBWT-L1-0000-00BE7	XPEBWT-H1-0000-00BE7		
		Q2	87.4	XPEBWT-L1-0000-00AE7	XPEBWT-H1-0000-00AE7		
		P4	80.6			XPEBWT-P1-0000-009E7	XPEBWT-U1-0000-009E7
		P3	73.9			XPEBWT-P1-0000-008E7	XPEBWT-U1-0000-008E7
		P2	67.2			XPEBWT-P1-0000-007E7	XPEBWT-U1-0000-007E7
Z7	3000 K	Q3	93.9	XPEBWT-L1-0000-00BZ7	XPEBWT-H1-0000-00BZ7		
		Q2	87.4	XPEBWT-L1-0000-00AZ7	XPEBWT-H1-0000-00AZ7		
		P4	80.6			XPEBWT-P1-0000-009Z7	
		P3	73.9			XPEBWT-P1-0000-008Z7	XPEBWT-U1-0000-008Z7
		P2	67.2			XPEBWT-P1-0000-007Z7	XPEBWT-U1-0000-007Z7
F8	2850 K	Q3	93.9	XPEBWT-L1-0000-00BF8			
		Q2	87.4	XPEBWT-L1-0000-00AF8	XPEBWT-H1-0000-00AF8		
		P4	80.6	XPEBWT-L1-0000-009F8	XPEBWT-H1-0000-009F8	XPEBWT-P1-0000-009F8	
		P3	73.9			XPEBWT-P1-0000-008F8	XPEBWT-U1-0000-008F8
		P2	67.2			XPEBWT-P1-0000-007F8	XPEBWT-U1-0000-007F8
		N4	62			XPEBWT-P1-0000-006F8	XPEBWT-U1-0000-006F8
E8	2700 K	Q3	93.9	XPEBWT-L1-0000-00BE8			
		Q2	87.4	XPEBWT-L1-0000-00AE8	XPEBWT-H1-0000-00AE8		
		P4	80.6	XPEBWT-L1-0000-009E8	XPEBWT-H1-0000-009E8		
		P3	73.9			XPEBWT-P1-0000-008E8	XPEBWT-U1-0000-008E8
		P2	67.2			XPEBWT-P1-0000-007E8	XPEBWT-U1-0000-007E8
		N4	62			XPEBWT-P1-0000-006E8	XPEBWT-U1-0000-006E8

* Cree XLamp XP Family LED order codes specify only a minimum flux bin and not a maximum. Cree may ship reels in flux bins higher than the minimum specified by the order code without advance notice. Shipments will always adhere to the chromaticity or DWL bin restrictions specified by the order code.

STANDARD ORDER CODES AND BINS (XP-E2 WARM WHITE, T_j = 85 °C) - CONTINUED

XLamp XP-E2 LED Standard Kit Codes - White							
Chromaticity		Minimum Luminous Flux (lm) @ 350 mA*		Order Codes			
Kit	CCT	Code	Flux (lm)	80 CRI Typical	80 CRI Minimum	85 CRI Minimum	90 CRI Minimum
ANSI Warm White (2700 K - 3750 K)							
Z8	2700 K	Q2	87.4	XPEBWT-L1-0000-00AZ8	XPEBWT-H1-0000-00AZ8		
		P4	80.6	XPEBWT-L1-0000-009Z8	XPEBWT-H1-0000-009Z8		
		P3	73.9			XPEBWT-P1-0000-008Z8	
		P2	67.2			XPEBWT-P1-0000-007Z8	XPEBWT-U1-0000-007Z8
		N4	62			XPEBWT-P1-0000-006Z8	XPEBWT-U1-0000-006Z8
EA	2200 K	P2	67.2	XPEBWT-L1-0000-007EA	XPEBWT-H1-0000-007EA		
		N4	62	XPEBWT-L1-0000-006EA	XPEBWT-H1-0000-006EA		

* Cree XLamp XP Family LED order codes specify only a minimum flux bin and not a maximum. Cree may ship reels in flux bins higher than the minimum specified by the order code without advance notice. Shipments will always adhere to the chromaticity or DWL bin restrictions specified by the order code.

STANDARD ORDER CODES AND BINS (XP-E2 COLOR, T_j = 25 °C)

XLamp XP-E2 LED Standard Order Codes - Royal Blue							
Color	Minimum Radiant Flux @ 350 mA		Dominant Wavelength (nm)				Order Codes
	Group	Flux (mW)	Min.		Max.		
			Group	DWL (nm)	Group	DWL (nm)	
Royal Blue	30	450	D3	450	D5	465	XPEBRY-L1-0000-00J01
			D3	450	D4	460	XPEBRY-L1-0000-00J02
			D4	455	D5	465	XPEBRY-L1-0000-00J03
	31	475	D3	450	D5	455	XPEBRY-L1-0000-00K01
			D3	450	D4	460	XPEBRY-L1-0000-00K02
			D4	455	D5	465	XPEBRY-L1-0000-00K03
	32	500	D3	450	D5	455	XPEBRY-L1-0000-00L01
			D3	450	D4	460	XPEBRY-L1-0000-00L02
			D4	455	D5	465	XPEBRY-L1-0000-00L03
	33	525	D3	450	D5	455	XPEBRY-L1-0000-00M01
			D3	450	D4	460	XPEBRY-L1-0000-00M02
			D4	455	D5	465	XPEBRY-L1-0000-00M03
	34	550	D3	450	D5	455	XPEBRY-L1-0000-00N01
			D3	450	D4	460	XPEBRY-L1-0000-00N02
			D4	455	D5	465	XPEBRY-L1-0000-00N03
	35	575	D3	450	D5	465	XPEBRY-L1-0000-00P01
			D3	450	D4	460	XPEBRY-L1-0000-00P02
			D4	455	D5	465	XPEBRY-L1-0000-00P03
	36	600	D3	450	D5	465	XPEBRY-L1-0000-00Q01
			D3	450	D4	460	XPEBRY-L1-0000-00Q02

* Cree XLamp XP Family LED order codes specify only a minimum flux bin and not a maximum. Cree may ship reels in flux bins higher than the minimum specified by the order code without advance notice. Shipments will always adhere to the chromaticity or DWL bin restrictions specified by the order code.

STANDARD ORDER CODES AND BINS (XP-E2 COLOR, T_j = 25 °C) - CONTINUED

XLamp XP-E2 LED Standard Order Codes - Color							
Color	Min. Luminous Flux (lm) @ 350 mA*		Dominant Wavelength (nm)				Order Codes
	Group	Flux (lm)	Min.		Max.		
			Group	DWL (nm)	Group	DWL (nm)	
Blue	K2	30.6	B3	465	B6	485	XPEBBL-L1-0000-00Y01
			B3	465	B5	480	XPEBBL-L1-0000-00Y02
			B4	470	B5	480	XPEBBL-L1-0000-00Y05
	K3	35.2	B3	465	B6	485	XPEBBL-L1-0000-00Z01
			B3	465	B5	480	XPEBBL-L1-0000-00Z02
			B4	470	B5	480	XPEBBL-L1-0000-00Z05
	M2	39.8	B3	465	B6	485	XPEBBL-L1-0000-00201
			B3	465	B5	480	XPEBBL-L1-0000-00202
			B4	470	B5	480	XPEBBL-L1-0000-00205
	M3	45.7	B3	465	B6	485	XPEBBL-L1-0000-00301
			B3	465	B5	480	XPEBBL-L1-0000-00302
			B4	470	B5	480	XPEBBL-L1-0000-00305
Green	Q2	87.4	G2	520	G4	535	XPEBGR-L1-0000-00A01
			G2	520	G3	530	XPEBGR-L1-0000-00A02
			G3	525	G4	535	XPEBGR-L1-0000-00A03
	Q3	93.9	G2	520	G4	535	XPEBGR-L1-0000-00B01
			G2	520	G3	530	XPEBGR-L1-0000-00B02
			G3	525	G4	535	XPEBGR-L1-0000-00B03
	Q4	100	G2	520	G4	535	XPEBGR-L1-0000-00C01
			G2	520	G3	530	XPEBGR-L1-0000-00C02
			G3	525	G4	535	XPEBGR-L1-0000-00C03
	Q5	107	G2	520	G4	535	XPEBGR-L1-0000-00D01
			G2	520	G3	530	XPEBGR-L1-0000-00D02
			G3	525	G4	535	XPEBGR-L1-0000-00D03
	R2	114	G2	520	G4	535	XPEBGR-L1-0000-00E01
			G2	520	G3	530	XPEBGR-L1-0000-00E02
			G3	525	G4	535	XPEBGR-L1-0000-00E03
	R3	122	G2	520	G4	535	XPEBGR-L1-0000-00F01
			G2	520	G3	530	XPEBGR-L1-0000-00F02

Color	Color Bin	Min. Luminous Flux (lm) @ 350 mA		Order Codes
		Group	Flux (lm)	
PC Amber	Y2	Q2	87.4	XPEBPA-L1-0000-00A01
		Q3	93.9	XPEBPA-L1-0000-00B01
		Q4	100	XPEBPA-L1-0000-00C01

* Cree XLamp XP Family LED order codes specify only a minimum flux bin and not a maximum. Cree may ship reels in flux bins higher than the minimum specified by the order code without advance notice. Shipments will always adhere to the chromaticity or DWL bin restrictions specified by the order code.

STANDARD ORDER CODES AND BINS (XP-E2 COLOR, T_j = 25 °C) - CONTINUED

XLamp XP-E2 LED Standard Order Codes - Color							
Color	Min. Luminous Flux (lm) @ 350 mA*		Dominant Wavelength (nm)				Order Codes
	Group	Flux (lm)	Min.		Max.		
			Group	DWL (nm)	Group	DWL (nm)	
Amber	N4	62.0	A2	585	A3	595	XPEBAM-L1-0000-00601
			A2	585	A2	590	XPEBAM-L1-0000-00602
			A3	590	A3	595	XPEBAM-L1-0000-00603
	P2	67.2	A2	585	A3	595	XPEBAM-L1-0000-00701
			A2	585	A2	590	XPEBAM-L1-0000-00702
			A3	590	A3	595	XPEBAM-L1-0000-00703
	P3	73.9	A2	585	A3	595	XPEBAM-L1-0000-00801
			A2	585	A2	590	XPEBAM-L1-0000-00802
			A3	590	A3	595	XPEBAM-L1-0000-00803
	P4	80.6	A2	585	A3	595	XPEBAM-L1-0000-00901
			A3	590	A3	595	XPEBAM-L1-0000-00903
	Red-Orange	P2	67.2	O3	610	O4	620
O3				610	O3	615	XPEBRO-L1-0000-00702
O4				615	O4	620	XPEBRO-L1-0000-00703
P3		73.9	O3	610	O4	620	XPEBRO-L1-0000-00801
			O3	610	O3	615	XPEBRO-L1-0000-00802
			O4	615	O4	620	XPEBRO-L1-0000-00803
P4		80.6	O3	610	O4	620	XPEBRO-L1-0000-00901
			O3	610	O3	615	XPEBRO-L1-0000-00902
			O4	615	O4	620	XPEBRO-L1-0000-00903
Q2		87.4	O3	610	O4	620	XPEBRO-L1-0000-00A01
			O3	610	O3	615	XPEBRO-L1-0000-00A02
			O4	615	O4	620	XPEBRO-L1-0000-00A03
Q3		93.9	O3	610	O4	620	XPEBRO-L1-0000-00B01
			O3	610	O3	615	XPEBRO-L1-0000-00B02
Q4		100	O3	610	O4	620	XPEBRO-L1-0000-00C01
			O3	610	O3	615	XPEBRO-L1-0000-00C02
Q5		107	O3	610	O4	620	XPEBRO-L1-0000-00D01
			O3	610	O3	615	XPEBRO-L1-0000-00D02
Red	N3	56.8	R2	620	R3	630	XPEBRD-L1-0000-00501
			R2	620	R2	625	XPEBRD-L1-0000-00502
	N4	62	R2	620	R3	630	XPEBRD-L1-0000-00601
			R2	620	R2	625	XPEBRD-L1-0000-00602
	P2	67.2	R2	620	R3	630	XPEBRD-L1-0000-00701
			R2	620	R2	625	XPEBRD-L1-0000-00702
	P3	73.9	R2	620	R3	630	XPEBRD-L1-0000-00801
			R2	620	R2	625	XPEBRD-L1-0000-00802

* Cree XLamp XP Family LED order codes specify only a minimum flux bin and not a maximum. Cree may ship reels in flux bins higher than the minimum specified by the order code without advance notice. Shipments will always adhere to the chromaticity or DWL bin restrictions specified by the order code.

STANDARD ORDER CODES AND BINS (XP-E HEW ANSI COOL WHITE, T_j = 25 °C)

XLamp XP-E High Efficiency White LED Order Codes - White				
Chromaticity		Minimum Luminous Flux (lm) @ 350 mA*		Order Codes
Kit	CCT	Code	Flux (lm)	68 CRI Typical
ANSI Cool White (5000 K – 8300 K)				
51	6200 K	R5	139	XPEHEW-L1-0000-00H51
		R4	130	XPEHEW-L1-0000-00G51
		R3	122	XPEHEW-L1-0000-00F51
53	6000 K	R5	139	XPEHEW-L1-0000-00H53
		R4	130	XPEHEW-L1-0000-00G53
		R3	122	XPEHEW-L1-0000-00F53
50	6200 K	R5	139	XPEHEW-L1-0000-00H50
		R4	130	XPEHEW-L1-0000-00G50
		R3	122	XPEHEW-L1-0000-00F50

STANDARD ORDER CODES AND BINS (XP-E HEW NEUTRAL WHITE, OUTDOOR WHITE, T_j = 25 °C)

XLamp XP-E High Efficiency White LED Standard Kit Codes - White						
Chromaticity		Minimum Luminous Flux (lm) @ 350 mA*		Order Codes		
Kit	CCT	Code	Flux (lm)	70 CRI Typical	75 CRI Typical	80 CRI Minimum
ANSI Neutral White (3700 K – 5000 K)						
E3	5000 K	R3	122	XPEHEW-01-0000-00FE3	XPEHEW-L1-0000-00FE3	
		R2	114	XPEHEW-01-0000-00EE3	XPEHEW-L1-0000-00EE3	
		Q5	107		XPEHEW-L1-0000-00DE3	
C1	5000 K	R4	130	XPEHEW-01-0000-00GC1		
		R3	122	XPEHEW-01-0000-00FC1		
		R2	114	XPEHEW-01-0000-00EC1		
F4	4750 K	R3	122	XPEHEW-01-0000-00FF4	XPEHEW-L1-0000-00FF4	
		R2	114	XPEHEW-01-0000-00EF4	XPEHEW-L1-0000-00EF4	
		Q5	107		XPEHEW-L1-0000-00DF4	
D1	4750 K	R4	130	XPEHEW-01-0000-00GD1		
		R3	122	XPEHEW-01-0000-00FD1		
		R2	114	XPEHEW-01-0000-00ED1		
E4	4500 K	R3	122	XPEHEW-01-0000-00FE4	XPEHEW-L1-0000-00FE4	
		R2	114	XPEHEW-01-0000-00EE4	XPEHEW-L1-0000-00EE4	
		Q5	107		XPEHEW-L1-0000-00DE4	
D2	4500 K	R4	130	XPEHEW-01-0000-00GD2		
		R3	122	XPEHEW-01-0000-00FD2		
		R2	114	XPEHEW-01-0000-00ED2		
C2	4500 K	R4	130	XPEHEW-01-0000-00GC2		
		R3	122	XPEHEW-01-0000-00FC2		
		R2	114	XPEHEW-01-0000-00EC2		

* Cree XLamp XP Family LED order codes specify only a minimum flux bin and not a maximum. Cree may ship reels in flux bins higher than the minimum specified by the order code without advance notice. Shipments will always adhere to the chromaticity or DWL bin restrictions specified by the order code.

STANDARD ORDER CODES AND BINS (XP-E HEW NEUTRAL WHITE, OUTDOOR WHITE, T_j = 25 °C) - CONTINUED

XLamp XP-E High Efficiency White LED Standard Kit Codes - White						
Chromaticity		Minimum Luminous Flux (lm) @ 350 mA*		Order Codes		
Kit	CCT	Code	Flux (lm)	70 CRI Typical	75 CRI Typical	80 CRI Minimum
ANSI Neutral White (3700 K – 5000 K)						
C3	4300 K	R4	130	XPEHEW-01-0000-00GC3		
		R3	122	XPEHEW-01-0000-00FC3		
		R2	114	XPEHEW-01-0000-00EC3		
F5	4250 K	R3	122	XPEHEW-01-0000-00FF5	XPEHEW-L1-0000-00FF5	
		R2	114	XPEHEW-01-0000-00EF5	XPEHEW-L1-0000-00EF5	
		Q5	107		XPEHEW-L1-0000-00DF5	
E5	4000 K	R3	122	XPEHEW-01-0000-00FE5	XPEHEW-L1-0000-00FE5	
		R2	114	XPEHEW-01-0000-00EE5	XPEHEW-L1-0000-00EE5	XPEHEW-H1-0000-00EE5
		Q5	107		XPEHEW-L1-0000-00DE5	XPEHEW-H1-0000-00DE5

STANDARD ORDER CODES AND BINS (XP-E HEW NEUTRAL WHITE, OUTDOOR WHITE, T_j = 25 °C) - CONTINUED

XLamp XP-E High Efficiency White LED Standard Kit Codes - White								
Chromaticity		Minimum Luminous Flux (lm) @ 350 mA*		Order Codes				
Kit	CCT	Code	Flux (lm)	70 CRI Typical	80 CRI Typical	80 CRI Minimum	85 CRI Minimum	90 CRI Minimum
ANSI Warm White (2700 K - 3750 K)								
F6	3750 K	R2	114	XPEHEW-01-0000-00EF6	XPEHEW-L1-0000-00EF6	XPEHEW-H1-0000-00EF6		
		Q5	107	XPEHEW-01-0000-00DF6	XPEHEW-L1-0000-00DF6	XPEHEW-H1-0000-00DF6		
		Q4	100		XPEHEW-L1-0000-00CF6	XPEHEW-H1-0000-00CF6		
E6	3500 K	R2	114	XPEHEW-01-0000-00EE6	XPEHEW-L1-0000-00EE6			
		Q5	107	XPEHEW-01-0000-00DE6	XPEHEW-L1-0000-00DE6	XPEHEW-H1-0000-00DE6		
		Q4	100		XPEHEW-L1-0000-00CE6	XPEHEW-H1-0000-00CE6		
F7	3250 K	R2	114	XPEHEW-01-0000-00EF7				
		Q5	107	XPEHEW-01-0000-00DF7	XPEHEW-L1-0000-00DF7	XPEHEW-H1-0000-00DF7		
		Q4	100	XPEHEW-01-0000-00CF7	XPEHEW-L1-0000-00CF7	XPEHEW-H1-0000-00CF7		
		Q3	93.9		XPEHEW-L1-0000-00BF7	XPEHEW-H1-0000-00BF7		
		P3	73.9					
E7	3000 K	R2	114	XPEHEW-01-0000-00EE7				
		Q5	107	XPEHEW-01-0000-00DE7	XPEHEW-L1-0000-00DE7			
		Q4	100	XPEHEW-01-0000-00CE7	XPEHEW-L1-0000-00CE7	XPEHEW-H1-0000-00CE7		
		Q3	93.9		XPEHEW-L1-0000-00BE7	XPEHEW-H1-0000-00BE7	XPEHEW-P1-0000-00BE7	
		Q2	87.4				XPEHEW-P1-0000-00AE7	XPEHEW-U1-0000-00AE7
		P4	80.6				XPEHEW-P1-0000-009E7	XPEHEW-U1-0000-009E7

* Cree XLamp XP Family LED order codes specify only a minimum flux bin and not a maximum. Cree may ship reels in flux bins higher than the minimum specified by the order code without advance notice. Shipments will always adhere to the chromaticity or DWL bin restrictions specified by the order code.

STANDARD ORDER CODES AND BINS (XP-E HEW NEUTRAL WHITE, OUTDOOR WHITE, T_j = 25 °C) - CONTINUED

XLamp XP-E High Efficiency White LED Standard Kit Codes - White								
Chromaticity		Minimum Luminous Flux (lm) @ 350 mA*		Order Codes				
Kit	CCT	Code	Flux (lm)	70 CRI Typical	80 CRI Typical	80 CRI Minimum	85 CRI Minimum	90 CRI Minimum
ANSI Warm White (2700 K - 3750 K)								
F8	2850 K	Q5	107	XPEHEW-01-0000-00DF8				
		Q4	100	XPEHEW-01-0000-00CF8	XPEHEW-L1-0000-00CF8	XPEHEW-H1-0000-00CF8		
		Q3	93.9		XPEHEW-L1-0000-00BF8	XPEHEW-H1-0000-00BF8		
		Q2	87.4		XPEHEW-L1-0000-00AF8	XPEHEW-H1-0000-00AF8	XPEHEW-P1-0000-00AF8	XPEHEW-U1-0000-00AF8
		P4	80.6				XPEHEW-P1-0000-009F8	XPEHEW-U1-0000-009F8
		P3	73.9				XPEHEW-P1-0000-008F8	XPEHEW-U1-0000-008F8
E8	2700 K	Q5	107	XPEHEW-01-0000-00DE8				
		Q4	100	XPEHEW-01-0000-00CE8	XPEHEW-L1-0000-00CE8			
		Q3	93.9		XPEHEW-L1-0000-00BE8	XPEHEW-H1-0000-00BE8		
		Q2	87.4		XPEHEW-L1-0000-00AE8	XPEHEW-H1-0000-00AE8	XPEHEW-P1-0000-00AE8	
		P4	80.6				XPEHEW-P1-0000-009E8	XPEHEW-U1-0000-009E8
		P3	73.9				XPEHEW-P1-0000-008E8	XPEHEW-U1-0000-008E8

* Cree XLamp XP Family LED order codes specify only a minimum flux bin and not a maximum. Cree may ship reels in flux bins higher than the minimum specified by the order code without advance notice. Shipments will always adhere to the chromaticity or DWL bin restrictions specified by the order code.

STANDARD ORDER CODES AND BINS (XP-G ANSI COOL WHITE, T_j = 25 °C)

XLamp XP-G LED Standard Order Codes - White				
Chromaticity		Minimum Luminous Flux (lm) @ 350 mA*		Order Codes
Kit	CCT	Code	Flux (lm)	70 CRI Typical
ANSI Cool White (5000 K – 8300 K)				
51	6200 K	R5	139	XPGWHT-L1-0000-00H51
		R4	130	XPGWHT-L1-0000-00G51
		R3	122	XPGWHT-L1-0000-00F51
53	6000 K	R5	139	XPGWHT-L1-0000-00H53
		R4	130	XPGWHT-L1-0000-00G53
		R3	122	XPGWHT-L1-0000-00F53
50	6200 K	R5	139	XPGWHT-L1-0000-00H50
		R4	130	XPGWHT-L1-0000-00G50
		R3	122	XPGWHT-L1-0000-00F50
E1	6500 K	R5	139	XPGWHT-L1-0000-00HE1
		R4	130	XPGWHT-L1-0000-00GE1
		R3	122	XPGWHT-L1-0000-00FE1
E2	5700 K	R5	139	XPGWHT-L1-0000-00HE2
		R4	130	XPGWHT-L1-0000-00GE2
		R3	122	XPGWHT-L1-0000-00FE2

* Cree XLamp XP Family LED order codes specify only a minimum flux bin and not a maximum. Cree may ship reels in flux bins higher than the minimum specified by the order code without advance notice. Shipments will always adhere to the chromaticity or DWL bin restrictions specified by the order code.

STANDARD ORDER CODES AND BINS (XP-G NEUTRAL WHITE, OUTDOOR WHITE, T_j = 25 °C)

XLamp XP-G LED Standard Kit Codes - White						
Chromaticity		Minimum Luminous Flux (lm) @ 350 mA*		Order Codes		
Kit	CCT	Code	Flux (lm)	70 CRI Typical	75 CRI Typical	80 CRI Minimum
ANSI Neutral White (3700 K – 5000 K)						
E3	5000 K	R5	139	XPGWHT-01-0000-00HE3		
		R4	130	XPGWHT-01-0000-00GE3		
		R3	122	XPGWHT-01-0000-00FE3	XPGWHT-L1-0000-00FE3	
		R2	114	XPGWHT-01-0000-00EE3	XPGWHT-L1-0000-00EE3	
		Q5	107		XPGWHT-L1-0000-00DE3	
C1	5000 K	R5	139	XPGWHT-01-0000-00HC1		
		R4	130	XPGWHT-01-0000-00GC1		
		R3	122	XPGWHT-01-0000-00FC1		
		R2	114	XPGWHT-01-0000-00EC1		
F4	4750 K	R5	139	XPGWHT-01-0000-00HF4		
		R4	130	XPGWHT-01-0000-00GF4		
		R3	122	XPGWHT-01-0000-00FF4	XPGWHT-L1-0000-00FF4	
		R2	114	XPGWHT-01-0000-00EF4	XPGWHT-L1-0000-00EF4	
		Q5	107		XPGWHT-L1-0000-00DF4	
D1	4750 K	R5	139	XPGWHT-01-0000-00HD1		
		R4	130	XPGWHT-01-0000-00GD1		
		R3	122	XPGWHT-01-0000-00FD1		
		R2	114	XPGWHT-01-0000-00ED1		
E4	4500 K	R5	139	XPGWHT-01-0000-00HE4		
		R4	130	XPGWHT-01-0000-00GE4		
		R3	122	XPGWHT-01-0000-00FE4	XPGWHT-L1-0000-00FE4	
		R2	114	XPGWHT-01-0000-00EE4	XPGWHT-L1-0000-00EE4	
		Q5	107		XPGWHT-L1-0000-00DE4	
D2	4500 K	R5	139	XPGWHT-01-0000-00HD2		
		R4	130	XPGWHT-01-0000-00GD2		
		R3	122	XPGWHT-01-0000-00FD2		
		R2	114	XPGWHT-01-0000-00ED2		
C2	4500 K	R5	139	XPGWHT-01-0000-00HC2		
		R4	130	XPGWHT-01-0000-00GC2		
		R3	122	XPGWHT-01-0000-00FC2		
		R2	114	XPGWHT-01-0000-00EC2		
C3	4300 K	R4	130	XPGWHT-01-0000-00GC3		
		R3	122	XPGWHT-01-0000-00FC3		
D3	4300 K	R4	130	XPGWHT-01-0000-00GD3		
		R3	122	XPGWHT-01-0000-00FD3		
		R2	114	XPGWHT-01-0000-00ED3		

* Cree XLamp XP Family LED order codes specify only a minimum flux bin and not a maximum. Cree may ship reels in flux bins higher than the minimum specified by the order code without advance notice. Shipments will always adhere to the chromaticity or DWL bin restrictions specified by the order code.

STANDARD ORDER CODES AND BINS (XP-G NEUTRAL WHITE, OUTDOOR WHITE, T_j = 25 °C) - CONTINUED

XLamp XP-G LED Standard Kit Codes - White						
Chromaticity		Minimum Luminous Flux (lm) @ 350 mA*		Order Codes		
Kit	CCT	Code	Flux (lm)	70 CRI Typical	75 CRI Typical	80 CRI Minimum
ANSI Neutral White (3700 K – 5000 K)						
F5	4250 K	R4	130	XPGWHT-01-0000-00GF5		
		R3	122	XPGWHT-01-0000-00FF5	XPGWHT-L1-0000-00FF5	
		R2	114	XPGWHT-01-0000-00EF5	XPGWHT-L1-0000-00EF5	
		Q5	107		XPGWHT-L1-0000-00DF5	
C4	4100 K	R3	122	XPGWHT-01-0000-00FC4		
		R2	114	XPGWHT-01-0000-00EC4		
		Q5	107	XPGWHT-01-0000-00DC4		
D4	4000 K	R3	122	XPGWHT-01-0000-00FD4		
		R2	114	XPGWHT-01-0000-00ED4		
		Q5	107	XPGWHT-01-0000-00DD4		
E5	4000 K	R4	130	XPGWHT-01-0000-00GE5		
		R3	122	XPGWHT-01-0000-00FE5	XPGWHT-L1-0000-00FE5	
		R2	114	XPGWHT-01-0000-00EE5	XPGWHT-L1-0000-00EE5	XPGWHT-H1-0000-00EE5
		Q5	107		XPGWHT-L1-0000-00DE5	XPGWHT-H1-0000-00DE5
Z5	4000 K	R2	114		XPGWHT-L1-0000-00EZ5	XPGWHT-H1-0000-00EZ5
		Q5	107		XPGWHT-L1-0000-00DZ5	XPGWHT-H1-0000-00DZ5
C5	3800 K	R3	122	XPGWHT-01-0000-00FC5		
		R2	114	XPGWHT-01-0000-00EC5		
		Q5	107	XPGWHT-01-0000-00DC5		

* Cree XLamp XP Family LED order codes specify only a minimum flux bin and not a maximum. Cree may ship reels in flux bins higher than the minimum specified by the order code without advance notice. Shipments will always adhere to the chromaticity or DWL bin restrictions specified by the order code.

STANDARD ORDER CODES AND BINS (XP-G WARM WHITE, T_j = 25 °C)

XLamp XP-G LED Standard Kit Codes - White								
Chromaticity		Minimum Luminous Flux (lm) @ 350 mA*		Order Codes				
Kit	CCT	Code	Flux (lm)	70 CRI Typical	80 CRI Typical	80 CRI Minimum	85 CRI Minimum	90 CRI Minimum
ANSI Warm White (2700 K - 3750 K)								
F6	3750 K	R3	122	XPGWHT-01-0000-00FF6				
		R2	114	XPGWHT-01-0000-00EF6	XPGWHT-L1-0000-00EF6	XPGWHT-H1-0000-00EF6		
		Q5	107	XPGWHT-01-0000-00DF6	XPGWHT-L1-0000-00DF6	XPGWHT-H1-0000-00DF6		
		Q4	100		XPGWHT-L1-0000-00CF6	XPGWHT-H1-0000-00CF6		
D5	3700 K	R3	122	XPGWHT-01-0000-00FD5				
		R2	114	XPGWHT-01-0000-00ED5				
		Q5	107	XPGWHT-01-0000-00DD5				
C6	3600 K	R3	122	XPGWHT-01-0000-00FC6				
		R2	114	XPGWHT-01-0000-00EC6				
		Q5	107	XPGWHT-01-0000-00DC6				
E6	3500 K	R3	122	XPGWHT-01-0000-00FE6				
		R2	114	XPGWHT-01-0000-00EE6	XPGWHT-L1-0000-00EE6			
		Q5	107	XPGWHT-01-0000-00DE6	XPGWHT-L1-0000-00DE6	XPGWHT-H1-0000-00DE6		
		Q4	100		XPGWHT-L1-0000-00CE6	XPGWHT-H1-0000-00CE6		
Z6	3500 K	Q5	107		XPGWHT-L1-0000-00DZ6	XPGWHT-H1-0000-00DZ6		
		Q4	100		XPGWHT-L1-0000-00CZ6	XPGWHT-H1-0000-00CZ6		
F7	3250 K	R2	114		XPGWHT-L1-0000-00EF7			
		Q5	107		XPGWHT-L1-0000-00DF7	XPGWHT-H1-0000-00DF7		
		Q4	100		XPGWHT-L1-0000-00CF7	XPGWHT-H1-0000-00CF7		
		Q3	93.9		XPGWHT-L1-0000-00BF7	XPGWHT-H1-0000-00BF7		
E7	3000 K	R2	114		XPGWHT-L1-0000-00EE7			
		Q5	107		XPGWHT-L1-0000-00DE7	XPGWHT-H1-0000-00DE7		
		Q4	100		XPGWHT-L1-0000-00CE7	XPGWHT-H1-0000-00CE7		
		Q3	93.9		XPGWHT-L1-0000-00BE7	XPGWHT-H1-0000-00BE7	XPGWHT-P1-0000-00BE7	
		Q2	87.4				XPGWHT-P1-0000-00AE7	XPGWHT-U1-0000-00AE7
		P4	80.6				XPGWHT-P1-0000-009E7	XPGWHT-U1-0000-009E7
		P3	73.9				XPGWHT-P1-0000-008E7	XPGWHT-U1-0000-008E7
Z7	3000 K	Q5	107		XPGWHT-L1-0000-00DZ7	XPGWHT-H1-0000-00DZ7		
		Q4	100		XPGWHT-L1-0000-00CZ7	XPGWHT-H1-0000-00CZ7		
		Q3	93.9		XPGWHT-L1-0000-00BZ7	XPGWHT-H1-0000-00BZ7		
		Q2	87.4				XPGWHT-P1-0000-00AZ7	
		P4	80.6				XPGWHT-P1-0000-009Z7	XPGWHT-U1-0000-009Z7
		P3	73.9				XPGWHT-P1-0000-008Z7	XPGWHT-U1-0000-008Z7
F8	2850 K	Q5	107		XPGWHT-L1-0000-00DF8			
		Q4	100		XPGWHT-L1-0000-00CF8	XPGWHT-H1-0000-00CF8		
		Q3	93.9		XPGWHT-L1-0000-00BF8	XPGWHT-H1-0000-00BF8		
		Q2	87.4		XPGWHT-L1-0000-00AF8	XPGWHT-H1-0000-00AF8	XPGWHT-P1-0000-00AF8	
		P4	80.6				XPGWHT-P1-0000-009F8	XPGWHT-U1-0000-009F8
		P3	73.9				XPGWHT-P1-0000-008F8	XPGWHT-U1-0000-008F8
		P2	67.2				XPGWHT-P1-0000-007F8	XPGWHT-U1-0000-007F8

* Cree XLamp XP Family LED order codes specify only a minimum flux bin and not a maximum. Cree may ship reels in flux bins higher than the minimum specified by the order code without advance notice. Shipments will always adhere to the chromaticity or DWL bin restrictions specified by the order code.

STANDARD ORDER CODES AND BINS (XP-G WARM WHITE, T_j = 25 °C) - CONTINUED

XLamp XP-G LED Standard Kit Codes - White								
Chromaticity		Minimum Luminous Flux (lm) @ 350 mA*		Order Codes				
Kit	CCT	Code	Flux (lm)	70 CRI Typical	80 CRI Typical	80 CRI Minimum	85 CRI Minimum	90 CRI Minimum
ANSI Warm White (2700 K - 3750 K)								
E8	2700 K	Q5	107		XPGWHT-L1-0000-00DE8			
		Q4	100		XPGWHT-L1-0000-00CE8	XPGWHT-H1-0000-00CE8		
		Q3	93.9		XPGWHT-L1-0000-00BE8	XPGWHT-H1-0000-00BE8		
		Q2	87.4		XPGWHT-L1-0000-00AE8	XPGWHT-H1-0000-00AE8	XPGWHT-P1-0000-00AE8	
		P4	80.6				XPGWHT-P1-0000-009E8	XPGWHT-U1-0000-009E8
		P3	73.9				XPGWHT-P1-0000-008E8	XPGWHT-U1-0000-008E8
		P2	67.2				XPGWHT-P1-0000-007E8	XPGWHT-U1-0000-007E8
Z8	2700 K	Q4	100		XPGWHT-L1-0000-00CZ8	XPGWHT-H1-0000-00CZ8		
		Q3	93.9		XPGWHT-L1-0000-00BZ8	XPGWHT-H1-0000-00BZ8		
		Q2	87.4		XPGWHT-L1-0000-00AZ8	XPGWHT-H1-0000-00AZ8		
		P4	80.6				XPGWHT-P1-0000-009Z8	
		P3	73.9				XPGWHT-P1-0000-008Z8	XPGWHT-U1-0000-008Z8
		P2	67.2				XPGWHT-P1-0000-007Z8	XPGWHT-U1-0000-007Z8

* Cree XLamp XP Family LED order codes specify only a minimum flux bin and not a maximum. Cree may ship reels in flux bins higher than the minimum specified by the order code without advance notice. Shipments will always adhere to the chromaticity or DWL bin restrictions specified by the order code.

STANDARD ORDER CODES AND BINS (XP-G2 ANSI COOL WHITE, T_j = 85 °C)

XLamp XP-G2 LED Standard Order Codes - White				
Chromaticity		Minimum Luminous Flux (lm) @ 350 mA*		Order Codes
Kit	CCT	Code	Flux (lm)	70 CRI Typical
ANSI Cool White (5000 K – 8300 K)				
51	6200 K	S2	148	XPGBWT-L1-0000-00J51
		R5	139	XPGBWT-L1-0000-00H51
		R4	130	XPGBWT-L1-0000-00G51
		R3	122	XPGBWT-L1-0000-00F51
53	6000 K	S2	148	XPGBWT-L1-0000-00J53
		R5	139	XPGBWT-L1-0000-00H53
		R4	130	XPGBWT-L1-0000-00G53
		R3	122	XPGBWT-L1-0000-00F53
50	6200 K	S2	148	XPGBWT-L1-0000-00J50
		R5	139	XPGBWT-L1-0000-00H50
		R4	130	XPGBWT-L1-0000-00G50
		R3	122	XPGBWT-L1-0000-00F50
E1	6500 K	S2	148	XPGBWT-L1-0000-00JE1
		R5	139	XPGBWT-L1-0000-00HE1
		R4	130	XPGBWT-L1-0000-00GE1
		R3	122	XPGBWT-L1-0000-00FE1
E2	5700 K	S2	148	XPGBWT-L1-0000-00JE2
		R5	139	XPGBWT-L1-0000-00HE2
		R4	130	XPGBWT-L1-0000-00GE2
		R3	122	XPGBWT-L1-0000-00FE2

* Cree XLamp XP Family LED order codes specify only a minimum flux bin and not a maximum. Cree may ship reels in flux bins higher than the minimum specified by the order code without advance notice. Shipments will always adhere to the chromaticity or DWL bin restrictions specified by the order code.

STANDARD ORDER CODES AND BINS (XP-G2 NEUTRAL WHITE, OUTDOOR WHITE, T_j = 85 °C)

XLamp XP-G2 LED Standard Kit Codes - White						
Chromaticity		Minimum Luminous Flux (lm) @ 350 mA*		Order Codes		
Kit	CCT	Code	Flux (lm)	70 CRI Typical	75 CRI Typical	80 CRI Minimum
ANSI Neutral White (3700 K – 5000 K)						
E3	5000 K	R5	139	XPGBWT-01-0000-00HE3		
		R4	130	XPGBWT-01-0000-00GE3	XPGBWT-L1-0000-00GE3	
		R3	122	XPGBWT-01-0000-00FE3	XPGBWT-L1-0000-00FE3	
		R2	114	XPGBWT-01-0000-00EE3	XPGBWT-L1-0000-00EE3	
		Q5	107		XPGBWT-L1-0000-00DE3	
C1	5000 K	R5	139	XPGBWT-01-0000-00HC1		
		R4	130	XPGBWT-01-0000-00GC1		
		R3	122	XPGBWT-01-0000-00FC1		
		R2	114	XPGBWT-01-0000-00EC1		
F4	4750 K	R5	139	XPGBWT-01-0000-00HF4		
		R4	130	XPGBWT-01-0000-00GF4	XPGBWT-L1-0000-00GF4	
		R3	122	XPGBWT-01-0000-00FF4	XPGBWT-L1-0000-00FF4	
		R2	114	XPGBWT-01-0000-00EF4	XPGBWT-L1-0000-00EF4	
		Q5	107		XPGBWT-L1-0000-00DF4	
D1	4750 K	R5	139	XPGBWT-01-0000-00HD1		
		R4	130	XPGBWT-01-0000-00GD1		
		R3	122	XPGBWT-01-0000-00FD1		
		R2	114	XPGBWT-01-0000-00ED1		
E4	4500 K	R5	139	XPGBWT-01-0000-00HE4		
		R4	130	XPGBWT-01-0000-00GE4	XPGBWT-L1-0000-00GE4	
		R3	122	XPGBWT-01-0000-00FE4	XPGBWT-L1-0000-00FE4	
		R2	114	XPGBWT-01-0000-00EE4	XPGBWT-L1-0000-00EE4	
		Q5	107		XPGBWT-L1-0000-00DE4	
D2	4500 K	R5	139	XPGBWT-01-0000-00HD2		
		R4	130	XPGBWT-01-0000-00GD2		
		R3	122	XPGBWT-01-0000-00FD2		
		R2	114	XPGBWT-01-0000-00ED2		
C2	4500 K	R5	139	XPGBWT-01-0000-00HC2		
		R4	130	XPGBWT-01-0000-00GC2		
		R3	122	XPGBWT-01-0000-00FC2		
		R2	114	XPGBWT-01-0000-00EC2		
C3	4300 K	R5	139	XPGBWT-01-0000-00HC3		
		R4	130	XPGBWT-01-0000-00GC3		
		R3	122	XPGBWT-01-0000-00FC3		
		R2	114	XPGBWT-01-0000-00EC3		
D3	4300 K	R5	139	XPGBWT-01-0000-00HD3		
		R4	130	XPGBWT-01-0000-00GD3		
		R3	122	XPGBWT-01-0000-00FD3		
		R2	114	XPGBWT-01-0000-00ED3		

* Cree XLamp XP Family LED order codes specify only a minimum flux bin and not a maximum. Cree may ship reels in flux bins higher than the minimum specified by the order code without advance notice. Shipments will always adhere to the chromaticity or DWL bin restrictions specified by the order code.

STANDARD ORDER CODES AND BINS (XP-G2 NEUTRAL WHITE, OUTDOOR WHITE, T_j = 85 °C - CONTINUED)

XLamp XP-G2 LED Standard Kit Codes - White						
Chromaticity		Minimum Luminous Flux (lm) @ 350 mA*		Order Codes		
Kit	CCT	Code	Flux (lm)	70 CRI Typical	75 CRI Typical	80 CRI Minimum
ANSI Neutral White (3700 K – 5000 K)						
F5	4250 K	R5	139	XPGBWT-01-0000-00HF5		
		R4	130	XPGBWT-01-0000-00GF5	XPGBWT-L1-0000-00GF5	
		R3	122	XPGBWT-01-0000-00FF5	XPGBWT-L1-0000-00FF5	
		R2	114	XPGBWT-01-0000-00EF5	XPGBWT-L1-0000-00EF5	
		Q5	107		XPGBWT-L1-0000-00DF5	
C4	4100 K	R5	139	XPGBWT-01-0000-00HC4		
		R4	130	XPGBWT-01-0000-00GC4		
		R3	122	XPGBWT-01-0000-00FC4		
		R2	114	XPGBWT-01-0000-00EC4		
D4	4000 K	R5	139	XPGBWT-01-0000-00HD4		
		R4	130	XPGBWT-01-0000-00GD4		
		R3	122	XPGBWT-01-0000-00FD4		
		R2	114	XPGBWT-01-0000-00ED4		
E5	4000 K	R5	139	XPGBWT-01-0000-00HE5		
		R4	130	XPGBWT-01-0000-00GE5	XPGBWT-L1-0000-00GE5	
		R3	122	XPGBWT-01-0000-00FE5	XPGBWT-L1-0000-00FE5	XPGBWT-H1-0000-00FE5
		R2	114	XPGBWT-01-0000-00EE5	XPGBWT-L1-0000-00EE5	XPGBWT-H1-0000-00EE5
		Q5	107		XPGBWT-L1-0000-00DE5	XPGBWT-H1-0000-00DE5
Z5	4000 K	R3	122		XPGBWT-L1-0000-00FZ5	XPGBWT-H1-0000-00FZ5
		R2	114		XPGBWT-L1-0000-00EZ5	XPGBWT-H1-0000-00EZ5
		Q5	107		XPGBWT-L1-0000-00DZ5	XPGBWT-H1-0000-00DZ5
C5	3800 K	R5	139	XPGBWT-01-0000-00HC5		
		R4	130	XPGBWT-01-0000-00GC5		
		R3	122	XPGBWT-01-0000-00FC5		
		R2	114	XPGBWT-01-0000-00EC5		
		Q5	107	XPGBWT-01-0000-00DC5		

* Cree XLamp XP Family LED order codes specify only a minimum flux bin and not a maximum. Cree may ship reels in flux bins higher than the minimum specified by the order code without advance notice. Shipments will always adhere to the chromaticity or DWL bin restrictions specified by the order code.

STANDARD ORDER CODES AND BINS (XP-G2 WARM WHITE, T_j = 85 °C)

XLamp XP-G2 LED Standard Kit Codes - White								
Chromaticity		Minimum Luminous Flux (lm) @ 350 mA*		Order Codes				
Kit	CCT	Code	Flux (lm)	70 CRI Typical	80 CRI Typical	80 CRI Minimum	85 CRI Minimum	90 CRI Minimum
ANSI Warm White (2700 K - 3750 K)								
F6	3750 K	R5	139	XPGBWT-01-0000-00HF6				
		R4	130	XPGBWT-01-0000-00GF6	XPGBWT-L1-0000-00GF6	XPGBWT-H1-0000-00GF6		
		R3	122	XPGBWT-01-0000-00FF6	XPGBWT-L1-0000-00FF6	XPGBWT-H1-0000-00FF6		
		R2	114	XPGBWT-01-0000-00EF6	XPGBWT-L1-0000-00EF6	XPGBWT-H1-0000-00EF6		
		Q5	107	XPGBWT-01-0000-00DF6	XPGBWT-L1-0000-00DF6	XPGBWT-H1-0000-00DF6		
D5	3700 K	R4	130	XPGBWT-01-0000-00GD5				
		R3	122	XPGBWT-01-0000-00FD5				
		R2	114	XPGBWT-01-0000-00ED5				
		Q5	107	XPGBWT-01-0000-00DD5				
C6	3600 K	R4	130	XPGBWT-01-0000-00GC6				
		R3	122	XPGBWT-01-0000-00FC6				
		R2	114	XPGBWT-01-0000-00EC6				
		Q5	107	XPGBWT-01-0000-00DC6				
E6	3500 K	R4	130	XPGBWT-01-0000-00GE6	XPGBWT-L1-0000-00GE6	XPGBWT-H1-0000-00GE6		
		R3	122	XPGBWT-01-0000-00FE6	XPGBWT-L1-0000-00FE6	XPGBWT-H1-0000-00FE6		
		R2	114	XPGBWT-01-0000-00EE6	XPGBWT-L1-0000-00EE6	XPGBWT-H1-0000-00EE6		
		Q5	107	XPGBWT-01-0000-00DE6	XPGBWT-L1-0000-00DE6	XPGBWT-H1-0000-00DE6		
Z6	3500 K	R3	122		XPGBWT-L1-0000-00FZ6	XPGBWT-H1-0000-00FZ6		
		R2	114		XPGBWT-L1-0000-00EZ6	XPGBWT-H1-0000-00EZ6		
		Q5	107		XPGBWT-L1-0000-00DZ6	XPGBWT-H1-0000-00DZ6		
F7	3250 K	R4	130		XPGBWT-L1-0000-00GF7	XPGBWT-H1-0000-00GF7		
		R3	122		XPGBWT-L1-0000-00FF7	XPGBWT-H1-0000-00FF7		
		R2	114		XPGBWT-L1-0000-00EF7	XPGBWT-H1-0000-00EF7		
		Q5	107		XPGBWT-L1-0000-00DF7	XPGBWT-H1-0000-00DF7		
		Q4	100			XPGBWT-H1-0000-00CF7		
E7	3000 K	R4	130	XPGBWT-01-0000-00GE7	XPGBWT-L1-0000-00GE7	XPGBWT-H1-0000-00GE7		
		R3	122	XPGBWT-01-0000-00FE7	XPGBWT-L1-0000-00FE7	XPGBWT-H1-0000-00FE7		
		R2	114	XPGBWT-01-0000-00EE7	XPGBWT-L1-0000-00EE7	XPGBWT-H1-0000-00EE7		
		Q5	107		XPGBWT-L1-0000-00DE7	XPGBWT-H1-0000-00DE7		
		Q4	100		XPGBWT-L1-0000-00CE7	XPGBWT-H1-0000-00CE7		
		Q3	93.9				XPGBWT-P1-0000-00BE7	XPGBWT-U1-0000-00BE7
		Q2	87.4				XPGBWT-P1-0000-00AE7	XPGBWT-U1-0000-00AE7
		P4	80.6				XPGBWT-P1-0000-009E7	XPGBWT-U1-0000-009E7
		P3	73.9				XPGBWT-P1-0000-008E7	XPGBWT-U1-0000-008E7

* Cree XLamp XP Family LED order codes specify only a minimum flux bin and not a maximum. Cree may ship reels in flux bins higher than the minimum specified by the order code without advance notice. Shipments will always adhere to the chromaticity or DWL bin restrictions specified by the order code.

STANDARD ORDER CODES AND BINS (XP-G2 WARM WHITE T_j = 85 °C) - CONTINUED

XLamp XP-G2 LED Standard Kit Codes - White								
Chromaticity		Minimum Luminous Flux (lm) @ 350 mA*		Order Codes				
Kit	CCT	Code	Flux (lm)	70 CRI Typical	80 CRI Typical	80 CRI Minimum	85 CRI Minimum	90 CRI Minimum
ANSI Warm White (2700 K - 3750 K)								
Z7	3000 K	R3	122		XPGBWT-L1-0000-00FZ7	XPGBWT-H1-0000-00FZ7		
		R2	114		XPGBWT-L1-0000-00EZ7	XPGBWT-H1-0000-00EZ7		
		Q5	107		XPGBWT-L1-0000-00DZ7	XPGBWT-H1-0000-00DZ7		
		Q4	100		XPGBWT-L1-0000-00CZ7	XPGBWT-H1-0000-00CZ7		
		Q3	93.9					
		Q2	87.4				XPGBWT-P1-0000-00AZ7	XPGBWT-U1-0000-00AZ7
		P4	80.6				XPGBWT-P1-0000-009Z7	XPGBWT-U1-0000-009Z7
		P3	73.9				XPGBWT-P1-0000-008Z7	XPGBWT-U1-0000-008Z7
F8	2850 K	R2	114		XPGBWT-L1-0000-00EF8	XPGBWT-H1-0000-00EF8		
		Q5	107		XPGBWT-L1-0000-00DF8	XPGBWT-H1-0000-00DF8		
		Q4	100		XPGBWT-L1-0000-00CF8	XPGBWT-H1-0000-00CF8		
		Q3	93.9		XPGBWT-L1-0000-00BF8	XPGBWT-H1-0000-00BF8	XPGBWT-P1-0000-00BF8	
		Q2	87.4				XPGBWT-P1-0000-00AF8	XPGBWT-U1-0000-00AF8
		P4	80.6				XPGBWT-P1-0000-009F8	XPGBWT-U1-0000-009F8
		P3	73.9				XPGBWT-P1-0000-008F8	XPGBWT-U1-0000-008F8
		P2	67.2				XPGBWT-P1-0000-007F8	XPGBWT-U1-0000-007F8
E8	2700 K	R3	122		XPGBWT-L1-0000-00FE8	XPGBWT-H1-0000-00FE8		
		R2	114		XPGBWT-L1-0000-00EE8	XPGBWT-H1-0000-00EE8		
		Q5	107		XPGBWT-L1-0000-00DE8	XPGBWT-H1-0000-00DE8		
		Q4	100		XPGBWT-L1-0000-00CE8	XPGBWT-H1-0000-00CE8		
		Q3	93.9		XPGBWT-L1-0000-00BE8	XPGBWT-H1-0000-00BE8		
		Q2	87.4				XPGBWT-P1-0000-00AE8	XPGBWT-U1-0000-00AE8
		P4	80.6				XPGBWT-P1-0000-009E8	XPGBWT-U1-0000-009E8
		P3	73.9				XPGBWT-P1-0000-008E8	XPGBWT-U1-0000-008E8
Z8	2700 K	R2	114		XPGBWT-L1-0000-00EZ8	XPGBWT-H1-0000-00EZ8		
		Q5	107		XPGBWT-L1-0000-00DZ8	XPGBWT-H1-0000-00DZ8		
		Q4	100		XPGBWT-L1-0000-00CZ8	XPGBWT-H1-0000-00CZ8		
		Q3	93.9		XPGBWT-L1-0000-00BZ8	XPGBWT-H1-0000-00BZ8		
		Q2	87.4					
		P4	80.6				XPGBWT-P1-0000-009Z8	XPGBWT-U1-0000-009Z8
		P3	73.9				XPGBWT-P1-0000-008Z8	XPGBWT-U1-0000-008Z8
		P2	67.2				XPGBWT-P1-0000-007Z8	XPGBWT-U1-0000-007Z8

* Cree XLamp XP Family LED order codes specify only a minimum flux bin and not a maximum. Cree may ship reels in flux bins higher than the minimum specified by the order code without advance notice. Shipments will always adhere to the chromaticity or DWL bin restrictions specified by the order code.

STANDARD ORDER CODES AND BINS (XP-L ANSI COOL WHITE, $T_j = 85\text{ }^\circ\text{C}$)

XLamp XP-L LED Standard Order Codes - White				
Chromaticity		Minimum Luminous Flux (lm) @ 1050 mA*		Order Codes
Kit	CCT	Code	Flux (lm)	65 CRI Typical
ANSI Cool White (5000 K – 8300 K)				
51	6200 K	V5	460	XPLAWT-00-0000-0000V5051
		V4	440	XPLAWT-00-0000-0000V4051
		V3	420	XPLAWT-00-0000-0000V3051
53	6000 K	V5	460	XPLAWT-00-0000-0000V5053
		V4	440	XPLAWT-00-0000-0000V4053
		V3	420	XPLAWT-00-0000-0000V3053
50	6200 K	V5	460	XPLAWT-00-0000-0000V5050
		V4	440	XPLAWT-00-0000-0000V4050
		V3	420	XPLAWT-00-0000-0000V3050
E1	6500 K	V5	460	XPLAWT-00-0000-0000V50E1
		V4	440	XPLAWT-00-0000-0000V40E1
		V3	420	XPLAWT-00-0000-0000V30E1
E2	5700 K	V5	460	XPLAWT-00-0000-0000V50E2
		V4	440	XPLAWT-00-0000-0000V40E2
		V3	420	XPLAWT-00-0000-0000V30E2

* Cree XLamp XP Family LED order codes specify only a minimum flux bin and not a maximum. Cree may ship reels in flux bins higher than the minimum specified by the order code without advance notice. Shipments will always adhere to the chromaticity or DWL bin restrictions specified by the order code.

STANDARD ORDER CODES AND BINS (XP-L NEUTRAL WHITE, T_j = 85 °C)

XLamp XP-L LED Standard Kit Codes - White						
Chromaticity		Minimum Luminous Flux (lm) @ 1050 mA*		Order Codes		
Kit	CCT	Code	Flux (lm)	70 CRI Minimum	75 CRI Typical	80 CRI Minimum
ANSI Neutral White (3700 K – 5000 K)						
E3	5000 K	V4	440	XPLAWT-00-0000-000BV40E3	XPLAWT-00-0000-000LV40E3	
		V3	420	XPLAWT-00-0000-000BV30E3	XPLAWT-00-0000-000LV30E3	
		V2	400	XPLAWT-00-0000-000BV20E3	XPLAWT-00-0000-000LV20E3	
F4	4750 K	V4	440	XPLAWT-00-0000-000BV40F4	XPLAWT-00-0000-000LV40F4	
		V3	420	XPLAWT-00-0000-000BV30F4	XPLAWT-00-0000-000LV30F4	
		V2	400	XPLAWT-00-0000-000BV20F4	XPLAWT-00-0000-000LV20F4	
E4	4500 K	V4	440	XPLAWT-00-0000-000BV40E4	XPLAWT-00-0000-000LV40E4	
		V3	420	XPLAWT-00-0000-000BV30E4	XPLAWT-00-0000-000LV30E4	
		V2	400	XPLAWT-00-0000-000BV20E4	XPLAWT-00-0000-000LV20E4	
F5	4250 K	V4	440	XPLAWT-00-0000-000BV40F5	XPLAWT-00-0000-000LV40F5	
		V3	420	XPLAWT-00-0000-000BV30F5	XPLAWT-00-0000-000LV30F5	
		V2	400	XPLAWT-00-0000-000BV20F5	XPLAWT-00-0000-000LV20F5	
E5	4000 K	V4	440	XPLAWT-00-0000-000BV40E5	XPLAWT-00-0000-000LV40E5	
		V3	420	XPLAWT-00-0000-000BV30E5	XPLAWT-00-0000-000LV30E5	XPLAWT-00-0000-000HV30E5
		V2	400	XPLAWT-00-0000-000BV20E5	XPLAWT-00-0000-000LV20E5	XPLAWT-00-0000-000HV20E5
		U6	380	XPLAWT-00-0000-000BU60E5	XPLAWT-00-0000-000LU60E5	XPLAWT-00-0000-000HU60E5
Z5	4000 K	V4	440	XPLAWT-00-0000-000BV40Z5		
		V3	420	XPLAWT-00-0000-000BV30Z5	XPLAWT-00-0000-000LV30Z5	XPLAWT-00-0000-000HV30Z5
		V2	400	XPLAWT-00-0000-000BV20Z5	XPLAWT-00-0000-000LV20Z5	XPLAWT-00-0000-000HV20Z5
		U6	380	XPLAWT-00-0000-000BU60Z5	XPLAWT-00-0000-000LU60Z5	XPLAWT-00-0000-000HU60Z5
F6	3700 K	V2	400		XPLAWT-00-0000-000LV20F6	XPLAWT-00-0000-000LV20F6
		U6	380		XPLAWT-00-0000-000LU60F6	XPLAWT-00-0000-000LU60F6
		U5	360		XPLAWT-00-0000-000LU50F6	XPLAWT-00-0000-000LU50F6

* Cree XLamp XP Family LED order codes specify only a minimum flux bin and not a maximum. Cree may ship reels in flux bins higher than the minimum specified by the order code without advance notice. Shipments will always adhere to the chromaticity or DWL bin restrictions specified by the order code.

STANDARD ORDER CODES AND BINS (XP-L WARM WHITE, T_j = 85 °C)

XLamp XP-L LED Standard Kit Codes - White							
Chromaticity		Minimum Luminous Flux (lm) @ 1050 mA*		Order Codes			
Kit	CCT	Code	Flux (lm)	80 CRI Typical	80 CRI Minimum	85 CRI Minimum	90 CRI Minimum
ANSI Warm White (2700 K - 3500 K)							
E6	3500 K	V2	400	XPLAWT-00-0000-000LV20E6	XPLAWT-00-0000-000HV20E6		
		U6	380	XPLAWT-00-0000-000LU60E6	XPLAWT-00-0000-000HU60E6		
		U5	360	XPLAWT-00-0000-000LU50E6	XPLAWT-00-0000-000HU50E6		
Z6	3500 K	U6	380	XPLAWT-00-0000-000LU60Z6	XPLAWT-00-0000-000HU60Z6		
		U5	360	XPLAWT-00-0000-000LU50Z6	XPLAWT-00-0000-000HU50Z6		
F7	3250 K	U6	380	XPLAWT-00-0000-000LU60F7	XPLAWT-00-0000-000HU60F7		
		U5	360	XPLAWT-00-0000-000LU50F7	XPLAWT-00-0000-000HU50F7		
		U4	340	XPLAWT-00-0000-000LU40F7	XPLAWT-00-0000-000HU40F7		
E7	3000 K	U6	380	XPLAWT-00-0000-000LU60E7	XPLAWT-00-0000-000HU60E7		
		U5	360	XPLAWT-00-0000-000LU50E7	XPLAWT-00-0000-000HU50E7		
		U4	340	XPLAWT-00-0000-000LU40E7	XPLAWT-00-0000-000HU40E7		
		U3	320			XPLAWT-00-0000-000PU30E7	XPLAWT-00-0000-000UU30E7
		U2	300			XPLAWT-00-0000-000PU20E7	XPLAWT-00-0000-000UU20E7
		T6	280			XPLAWT-00-0000-000PT60E7	XPLAWT-00-0000-000UT60E7
Z7	3000 K	U6	380	XPLAWT-00-0000-000LU60Z7	XPLAWT-00-0000-000HU60Z7		
		U5	360	XPLAWT-00-0000-000LU50Z7	XPLAWT-00-0000-000HU50Z7		
		U4	340	XPLAWT-00-0000-000LU40Z7	XPLAWT-00-0000-000HU40Z7		
		U2	300			XPLAWT-00-0000-000PU20Z7	XPLAWT-00-0000-000UU20Z7
		T6	280			XPLAWT-00-0000-000PT60Z7	XPLAWT-00-0000-000UT60Z7
F8	2850 K	U6	380	XPLAWT-00-0000-000LU60F8	XPLAWT-00-0000-000HU60F8		
		U5	360	XPLAWT-00-0000-000LU50F8	XPLAWT-00-0000-000HU50F8		
		U4	340	XPLAWT-00-0000-000LU40F8	XPLAWT-00-0000-000HU40F8		
		U3	320			XPLAWT-00-0000-000PU30F8	XPLAWT-00-0000-000UU30F8
		U2	300			XPLAWT-00-0000-000PU20F8	XPLAWT-00-0000-000UU20F8
		T6	280			XPLAWT-00-0000-000PT60F8	XPLAWT-00-0000-000UT60F8
		T5	260			XPLAWT-00-0000-000PT50F8	XPLAWT-00-0000-000UT50F8
E8	2700 K	U6	380	XPLAWT-00-0000-000LU60E8			
		U5	360	XPLAWT-00-0000-000LU50E8	XPLAWT-00-0000-000HU50E8		
		U4	340	XPLAWT-00-0000-000LU40E8	XPLAWT-00-0000-000HU40E8		
		U3	320			XPLAWT-00-0000-000PU30E8	XPLAWT-00-0000-000UU30E8
		U2	300			XPLAWT-00-0000-000PU20E8	XPLAWT-00-0000-000UU20E8
		T6	280			XPLAWT-00-0000-000PT60E8	XPLAWT-00-0000-000UT60E8
		T5	260			XPLAWT-00-0000-000PT50E8	XPLAWT-00-0000-000UT50E8
Z8	2700 K	U5	360	XPLAWT-00-0000-000LU50Z8	XPLAWT-00-0000-000HU50Z8		
		U4	340	XPLAWT-00-0000-000LU40Z8	XPLAWT-00-0000-000HU40Z8		
		U2	300			XPLAWT-00-0000-000PU20Z8	
		T6	280			XPLAWT-00-0000-000PT60Z8	XPLAWT-00-0000-000UT60Z8
		T5	260			XPLAWT-00-0000-000PT50Z8	XPLAWT-00-0000-000UT50Z8

* Cree XLamp XP Family LED order codes specify only a minimum flux bin and not a maximum. Cree may ship reels in flux bins higher than the minimum specified by the order code without advance notice. Shipments will always adhere to the chromaticity or DWL bin restrictions specified by the order code.