

RCIKITP 24VAC 1CO LD

Weidmüller Interface GmbH & Co. KG

Klingenbergstraße 26

D-32758 Detmold

Germany

www.weidmueller.com

Product image

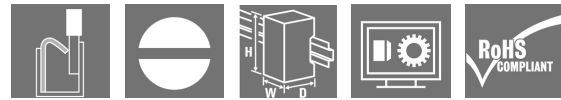
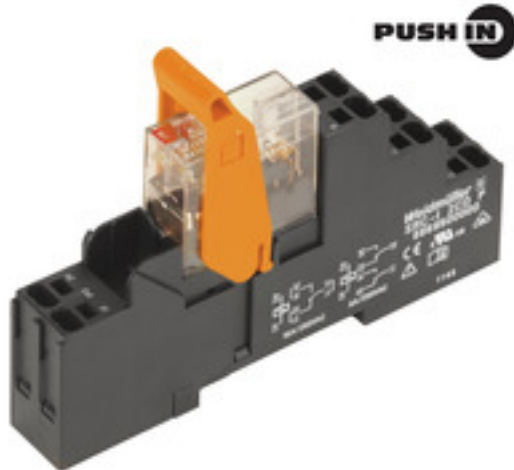

- Mounted kit consisting relay, socket and retaining clip
- 100 % function tested
- 100 % check of the dielectric strenght between input - output
- 1 CO contacts
- Optional test button with mechanical status indicator
- Bright status LED (AC coil: red / DC coil: green)
- identification of coils (AC red / DC blue)

General ordering data

Version	RIDERSERIES RCI, Relay module, Number of contacts: 1, CO contact AgNi, Rated control voltage: 24 V AC, Continuous current: 16 A, PUSH IN, Test button available: No
Order No.	8897120000
Type	RCIKITP 24VAC 1CO LD
GTIN (EAN)	4032248646890
Qty.	10 pc(s).
Relevant base	8869500000
Relevant relay	8870130000

Creation date April 20, 2022 1:06:23 PM CEST

RCIKITP 24VAC 1CO LD

Weidmüller Interface GmbH & Co. KG

Klingenbergstraße 26

D-32758 Detmold

Germany

www.weidmueller.com

Technical data

Dimensions and weights

Depth	69.6 mm	Depth (inches)	2.74 inch
Height	98 mm	Height (inches)	3.858 inch
Width	15.8 mm	Width (inches)	0.622 inch
Net weight	57.5 g		

Temperatures

Storage temperature	-40 °C...70 °C	Operating temperature	-40 °C...70 °C
Humidity	40 °C / 93 % rel. humidity, no condensation		

Environmental Product Compliance

REACH SVHC	Lead 7439-92-1
------------	----------------

Control side

Rated control voltage	24 V AC	Rated current AC	45 mA
Power rating	1080 mVA	Pull-in/drop-out voltage, typ.	18 V / 3.6 V AC
Coil resistance	350 Ω ± 10 %	Coil tolerance	10 %
Status indicator	red LED		

Load side

Rated switching voltage	250 V AC	Continuous current	16 A
Max. switching frequency at rated load	0.1 Hz	Min. switching power	1 mA @ 24 V, 10 mA @ 12 V, 100 mA @ 5 V
Inrush current	30 A / 4 s	AC switching capacity (resistive), max.	4000 VA
DC switching capacity (resistive), max.	384 W @ 24 V	Switch-on delay	≤ 8 ms
Switch-off delay	≤ 6 ms	Contact type	1 CO contact (AgNi)
Mechanical service life	AC coil 5 x 10 ⁶ switching cycles, DC coil 10 x 10 ⁶ switching cycles		

General data

Rail	TS 35	Test button available	No
Mechanical switch position indicator	No	Colour	black

Insulation coordination

Rated voltage	250 V	Pollution severity	2
Surge voltage category	III	Insulating material group	IIIa
Clearance and creepage distances for control side - load side	≥ 8 mm	Dielectric strength for control side - load side	5 kV _{eff} / 1 min
Dielectric strength of open contact	1 kV _{eff} / 1 min	Impulse withstand voltage	5 kV (1.2/50 μs)
Protection degree	IP20		

Further details of approvals / standards

Certificate No. (CSA)	249409-2426937	Certificate no. (CSA) relay	249409-2426937
Certificate no. (CSA) base	249409-2295474	Certificate No. (DNVGL)	TAA000011A
Certificate no. (cURus) relay	E224238	Certificate no. (cURus) base	E223759

RCIKITP 24VAC 1CO LD**Weidmüller Interface GmbH & Co. KG**

Klingenbergstraße 26

D-32758 Detmold

Germany

www.weidmueller.com

Technical data**Connection data**

Wire connection method	PUSH IN	Stripping length, rated connection	12 mm
Clamping range, rated connection	1.5 mm ²	Clamping range, min.	0.75 mm ²
Clamping range, max.	1.5 mm ²	Wire cross-section, solid, min.	0.75 mm ²
Wire cross-section, solid, max.	1.5 mm ²	Wire connection cross section, finely stranded, min.	0.75 mm ²
Wire connection cross section, finely stranded, max.	1.5 mm ²	Wire connection cross-section, finely stranded with wire-end ferrules DIN 46228/4, min.	0.75 mm ²
Wire connection cross-section, finely stranded with wire-end ferrules DIN 46228/4, max.	0.75 mm ²	Conductor cross-section, flexible, AEH (DIN 46228-1), min.	0.75 mm ²
Conductor cross-section, flexible, AEH (DIN 46228-1), max.	1 mm ²	Blade size	0.6 x 3.5 mm

Classifications

ETIM 6.0	EC001437	ETIM 7.0	EC001437
ETIM 8.0	EC001437	ECLASS 9.0	27-37-16-01
ECLASS 9.1	27-37-16-01	ECLASS 10.0	27-37-16-01
ECLASS 11.0	27-37-16-01		

Approvals

Approvals



ROHS

Conform

Downloads

Approval/Certificate/Document of Conformity	EU Konformitätserklärung / EU Declaration of Conformity
Engineering Data	CAD data – STEP
Engineering Data	EPLAN, WSCAD, Zuken E3.S
Catalogues	Catalogues in PDF-format
Brochures	

RCIKITP 24VAC 1CO LD

Weidmüller Interface GmbH & Co. KG
 Klingenbergstraße 26
 D-32758 Detmold
 Germany

www.weidmueller.com

Drawings

Wiring diagram

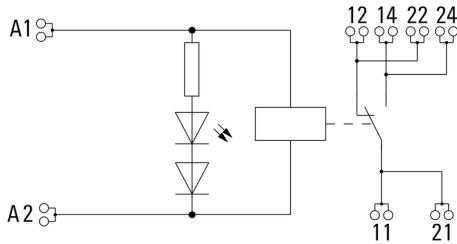

For full continuous current (16 A), the wire terminals 11 with 21, 12 with 22 and 14 with 24 must be bridged with a wire $\geq 1,5 \text{ mm}^2$ at the socket.

Graph

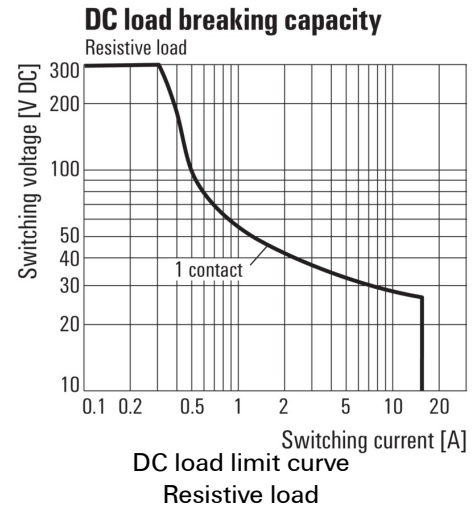

Graph

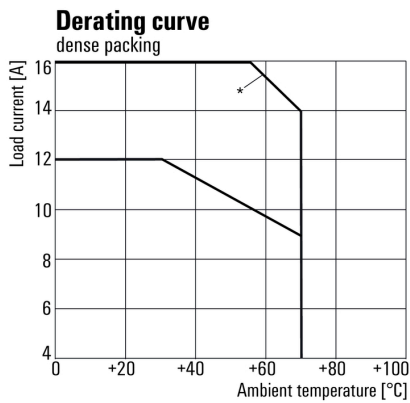

*For full continuous current (16 A), the wire terminals 11 with 21, 12 with 22 and 14 with 24 must be bridged with a wire $\geq 1,5 \text{ mm}^2$ at the socket.

Derating curve
 Relay in combination with base

Graph

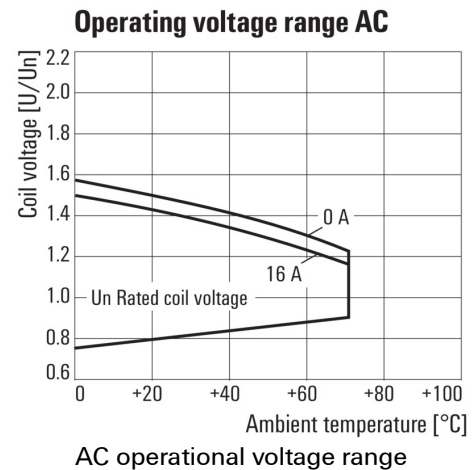

Graph

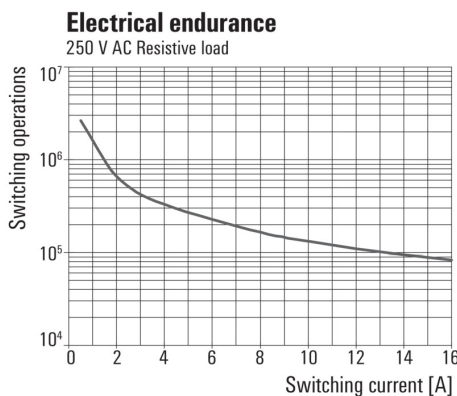

Electrical service life 250 V AC resistive load
 250 V AC resistive load

Dimensioned drawing

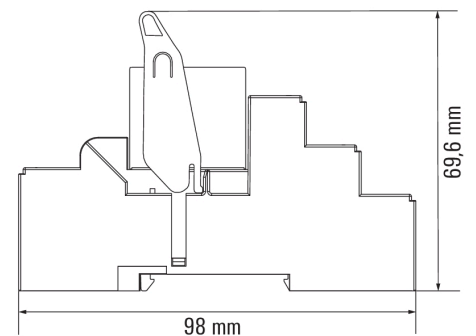

RCIKITP 24VAC 1CO LD

Weidmüller Interface GmbH & Co. KG
Klingenbergstraße 26
D-32758 Detmold
Germany

www.weidmueller.com

Drawings

Correct handling PUSH IN connection



Wrong handling PUSH IN connection

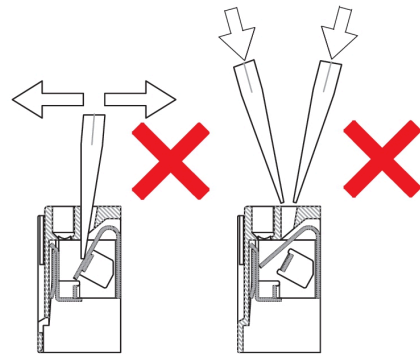

Recommended screwdriver



RCIKITP 24VAC 1CO LD

Weidmüller Interface GmbH & Co. KG
 Klingenbergstraße 26
 D-32758 Detmold
 Germany
 www.weidmueller.com

