



1N5921B~1N5942B

SILICON ZENER DIODES

VOLTAGE 6.8 to 51 Volt **POWER** 1.5 Watt

DO-41 Unit: inch(mm)

FEATURES

- Low profile package
- Built-in strain relief
- Low inductance
- Plastic package has Underwriters Laboratory Flammability Classification 94V-O
- Lead free in compliance with EU RoHS 2011/65/EU directive

MECHANICAL DATA

- Case: JEDEC DO-41, Molded plastic over passivated junction.
- Terminals: Solder plated, solderable per MIL-STD-750, Method 2026
- Polarity: Color band denotes positive end (cathode)
- Standard packing: 52mm tape
- Weight: 0.0118 ounce, 0.336 gram

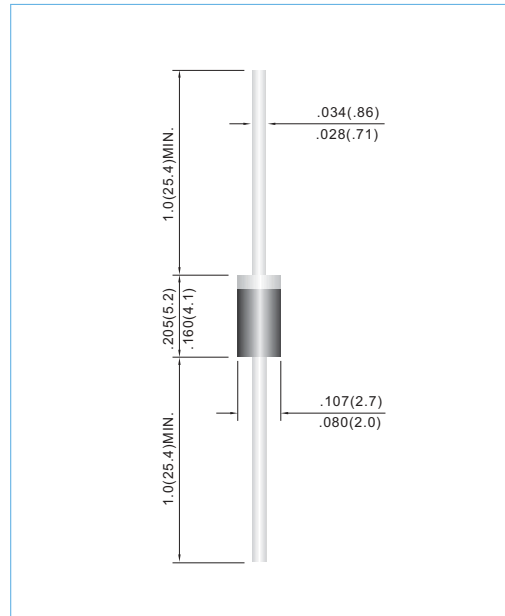

MAXIMUM RATINGS AND ELECTRICAL CHARACTERISTICS

Ratings at 25°C ambient temperature unless otherwise specified.

Parameter	Symbol	Value	Units
DC Power Dissipation on TA=75 °C ,Measure at Zero Lead Length Derate above 75°C (NOTE 1)	P _D	1.5	Watts
Operating Junction and Storage Temperature Range	T _J , T _{STG}	-55 to +150	°C

NOTES:

1. Mounted on 5.0mm² (.013mm thick) land areas.



1N5921B~1N5942B

Part Number	Nominal Zener Voltage			Maximum Zener Impedance				Maximum Leakage Current	
	V _Z @ I _{ZT}			Z _{VT} @ I _{ZT}		Z _{ZK} @ I _{ZK}		I _R	V _R
	Nom. V	Min. V	Max. V	Ω	mA	Ω	mA	μA	V
1N5921B	6.8	6.46	7.14	3	55.1	200	1	5	5.2
1N5922B	7.5	7.13	7.88	3	50	400	0.5	5	6
1N5923B	8.2	7.79	8.61	4	45.7	400	0.5	5	6.5
1N5924B	9.1	8.65	9.56	4	41.2	500	0.5	5	7
1N5925B	10	9.5	10.5	5	37.5	500	0.25	5	8
1N5926B	11	10.45	11.55	6	34.1	550	0.25	1	8.4
1N5927B	12	11.4	12.6	7	31.2	550	0.25	1	9.1
1N5928B	13	12.35	13.65	7	28.8	550	0.25	1	9.9
1N5929B	15	14.25	15.75	9	25	600	0.25	1	11.4
1N5930B	16	15.2	16.8	10	23.4	600	0.25	1	12.2
1N5931B	18	17.1	18.9	12	20.8	650	0.25	1	13.7
1N5932B	20	19	21	14	18.7	650	0.25	1	15.2
1N5933B	22	20.9	23.1	18	17	650	0.25	1	16.7
1N5934B	24	22.8	25.2	19	15.6	700	0.25	1	18.2
1N5935B	27	25.65	28.35	23	13.9	700	0.25	1	20.6
1N5936B	30	28.5	31.5	26	12.5	750	0.25	1	22.8
1N5937B	33	31.35	34.65	33	11.4	800	0.25	1	25.1
1N5938B	36	34.2	37.8	38	10.4	850	0.25	1	27.4
1N5939B	39	37.05	40.95	45	9.6	900	0.25	1	29.7
1N5940B	43	40.85	45.15	53	8.7	950	0.25	1	32.7
1N5941B	47	44.65	49.35	67	8	1000	0.25	1	35.8
1N5942B	51	48.45	53.55	70	7.3	1100	0.25	1	38.8



1N5921B~1N5942B

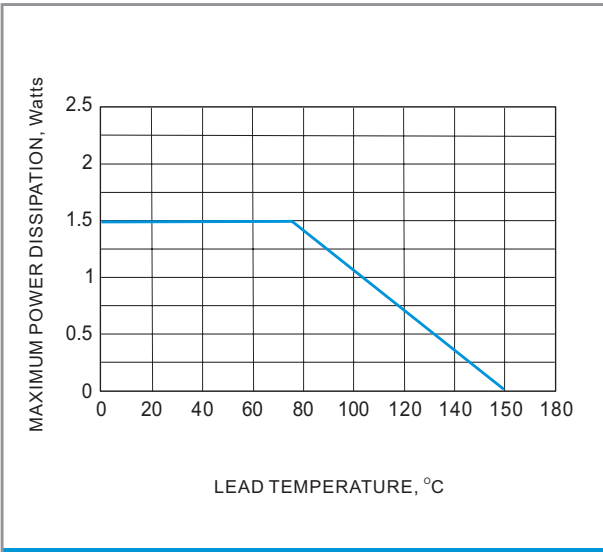

Fig.1 Steady State Power Derating

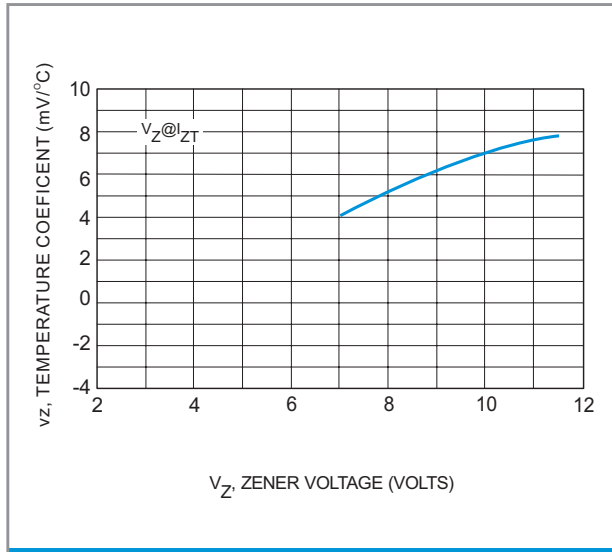

Fig.2 Temperature coefficient v.s. zener voltage, Vz(V)

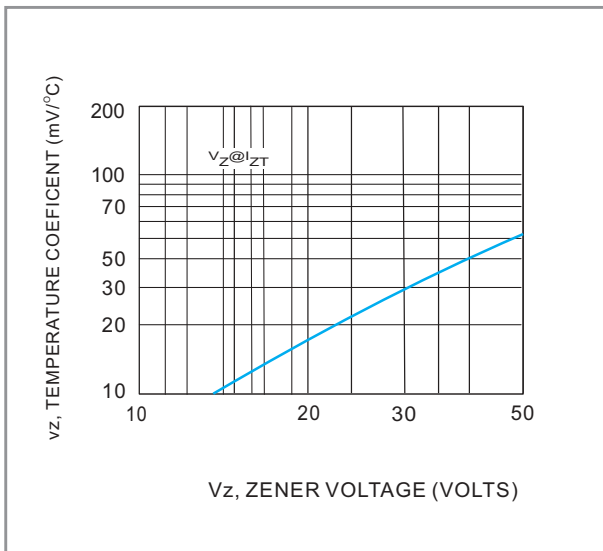

Fig.3 Temperature coefficient v.s. zener voltage, Vz(V)

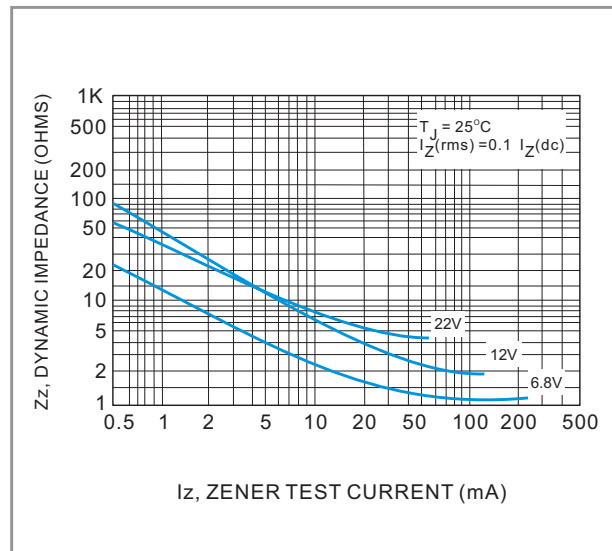

Fig.4 Zener impedance v.s. zener current

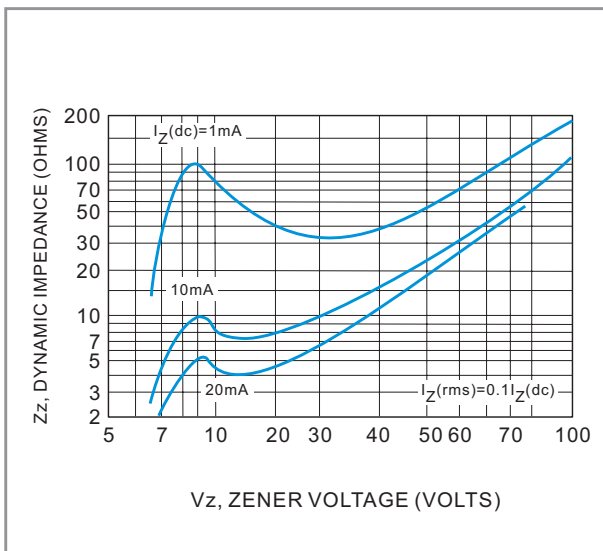

Fig.5 Zener impedance v.s. zener voltage

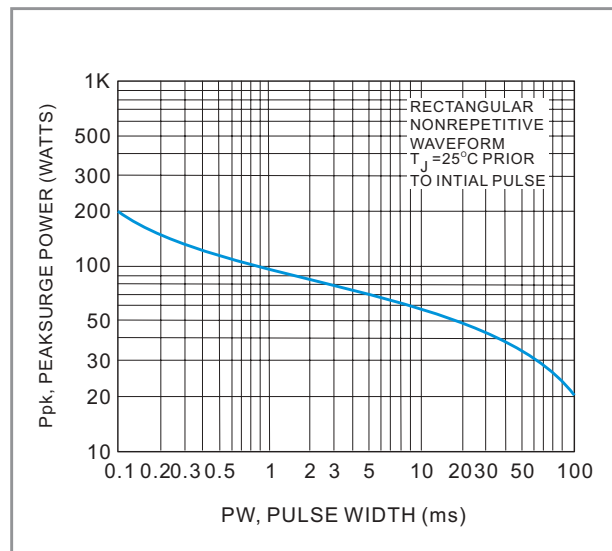
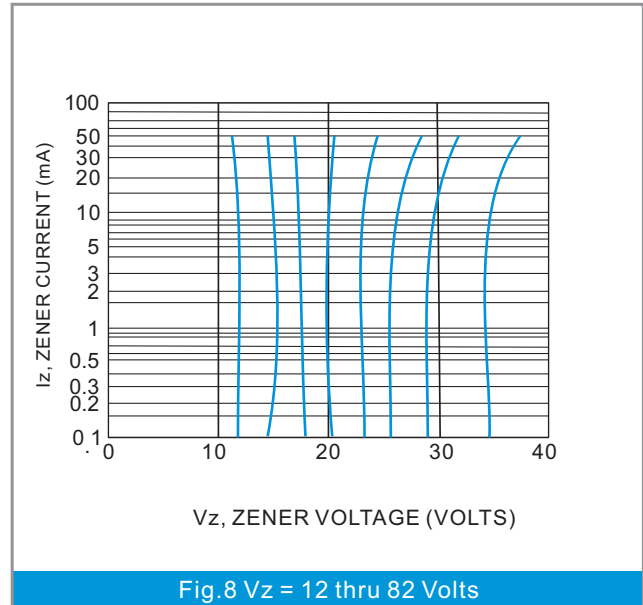
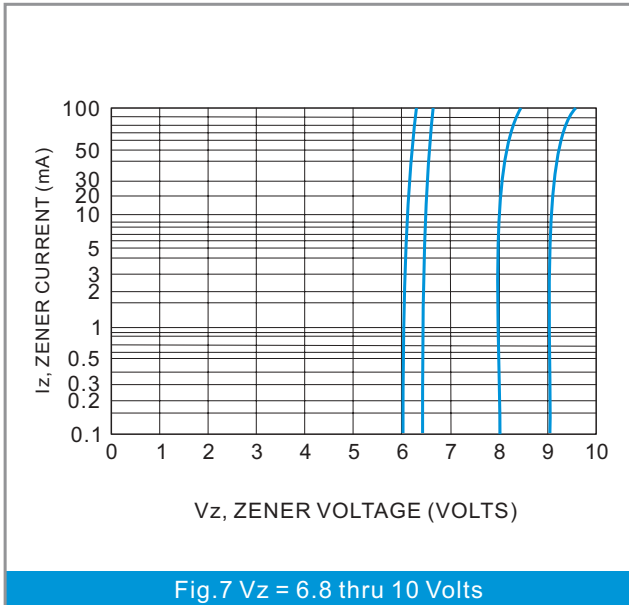

Fig.6 Maximum Surge Power



1N5921B~1N5942B



NOTE 3. ZENER VOLTAGE (V_z) MEASUREMENT

Nominal zener voltage is measured with the device function in thermal equilibrium with ambient temperature at 25°C

NOTE 4. ZENER IMPEDANCE (Z_z) DERIVATION

Z_{zt} and Z_{zk} are measured by dividing the ac voltage drop across the device by the accurent applied. The specified limits are for $I_z(ac) = 0.1 I_z, (dc)$ with the ac frequency = 60Hz



1N5921B~1N5942B

Part No_packing code_Version

- 1N5921B_AY_00001
- 1N5921B_AY_10001
- 1N5921B_B0_00001
- 1N5921B_B0_10001
- 1N5921B_R2_00001
- 1N5921B_R2_10001

For example :

RB500V-40_R2_00001



Packing Code XX				Version Code XXXXX		
Packing type	1 st Code	Packing size code	2 nd Code	HF or RoHS	1 st Code	2 nd ~5 th Code
Tape and Ammunition Box (T/B)	A	N/A	0	HF	0	serial number
Tape and Reel (T/R)	R	7"	1	RoHS	1	serial number
Bulk Packing (B/P)	B	13"	2			
Tube Packing (T/P)	T	26mm	X			
Tape and Reel (Right Oriented) (TRR)	S	52mm	Y			
Tape and Reel (Left Oriented) (TRL)	L	PANASERT T/B CATHODE UP (PBCU)	U			
FORMING	F	PANASERT T/B CATHODE DOWN (PBCD)	D			



1N5921B~1N5942B

Disclaimer

- Reproducing and modifying information of the document is prohibited without permission from Panjit International Inc..
- Panjit International Inc. reserves the rights to make changes of the content herein the document anytime without notification. Please refer to our website for the latest document.
- Panjit International Inc. disclaims any and all liability arising out of the application or use of any product including damages incidentally and consequentially occurred.
- Panjit International Inc. does not assume any and all implied warranties, including warranties of fitness for particular purpose, non-infringement and merchantability.
- Applications shown on the herein document are examples of standard use and operation. Customers are responsible in comprehending the suitable use in particular applications. Panjit International Inc. makes no representation or warranty that such applications will be suitable for the specified use without further testing or modification.
- The products shown herein are not designed and authorized for equipments requiring high level of reliability or relating to human life and for any applications concerning life-saving or life-sustaining, such as medical instruments, transportation equipment, aerospace machinery et cetera. Customers using or selling these products for use in such applications do so at their own risk and agree to fully indemnify Panjit International Inc. for any damages resulting from such improper use or sale.
- Since Panjit uses lot number as the tracking base, please provide the lot number for tracking when complaining.