



SM2

Linear Position to 25 inches (635 mm)
Fits In Tight Spaces | Handy Mounting Bracket
Polycarbonate Enclosure | Free Release Tolerant

SPECIFICATIONS

Available Stroke Ranges	2.375, 7.5, 12.5, 25 inches
Output Signal	voltage divider (potentiometric)
Accuracy	.25% to 1% FS. (See ordering info)
Repeatability	.05% FS.
Resolution	essentially infinite
Measuring Cable	.014-inch dia. nylon-coated stainless steel
Maximum Acceleration	15 g (retraction)
Measuring Cable Tension	5.1 oz. (1,4 N) ±30%
Sensor	Plastic-hybrid precision potentiometer
Input Resistance	10K ohms, ±10%
Power Rating, Watts	2.0 at 70°F derated to 0 at 250°
Max Input Voltage	30 V (AC/DC)
Sensitivity	940 ±40 mV/V FS
Cycle Life	See ordering information
Electrical Connection	40 inch (1 m), 24 ga. Shielded 3-conductor cable
Enclosure	Glass-filled polycarbonate
Environmental	IP 50
Operating Temperature	0° to 160° F (-18° to 70° C)
Weight (not including bracket)	3 oz (90 g)

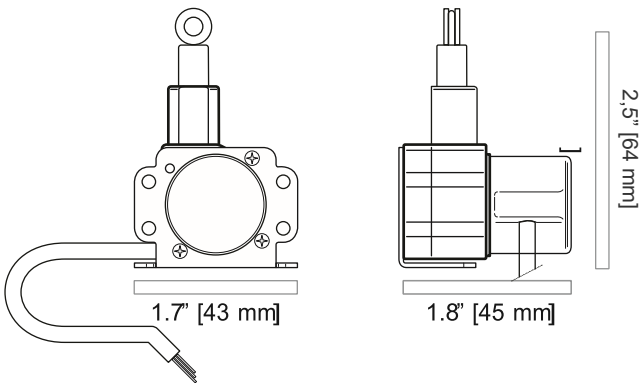

Just like the SM1, the SM2 is the perfect sensing solution when tight space is an issue. With its rugged compact design, handy mounting bracket and a 40-inch electrical cable for easy signal connection, the SM2 is the perfect solution for the OEM and single piece users alike.

At just a little over an inch across, this miniature stringpot offers full stroke measurement ranges from 2½ to 25 inches. A precision plastic hybrid 10K-ohm potentiometer delivers a voltage divider output signal that is linearly proportional to the travel of the spring-loaded measuring cable.

Output Signal:

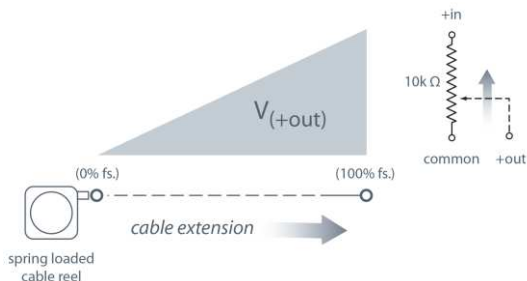

SM2

Miniature String Pot | Voltage Divider Output

Electrical Connection:

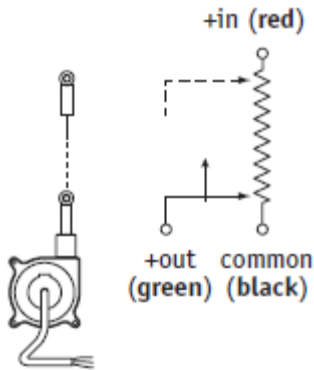

Mounting Options:

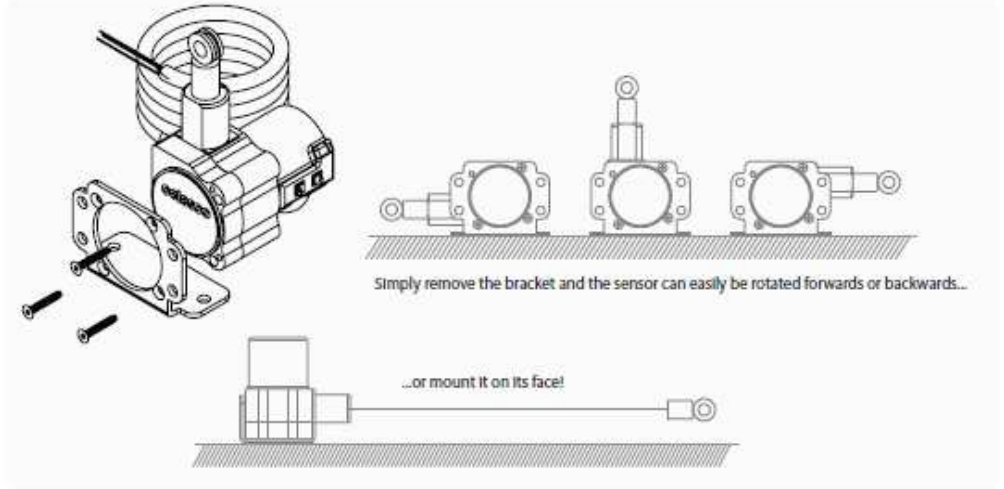

Outline Drawing (w/bracket):

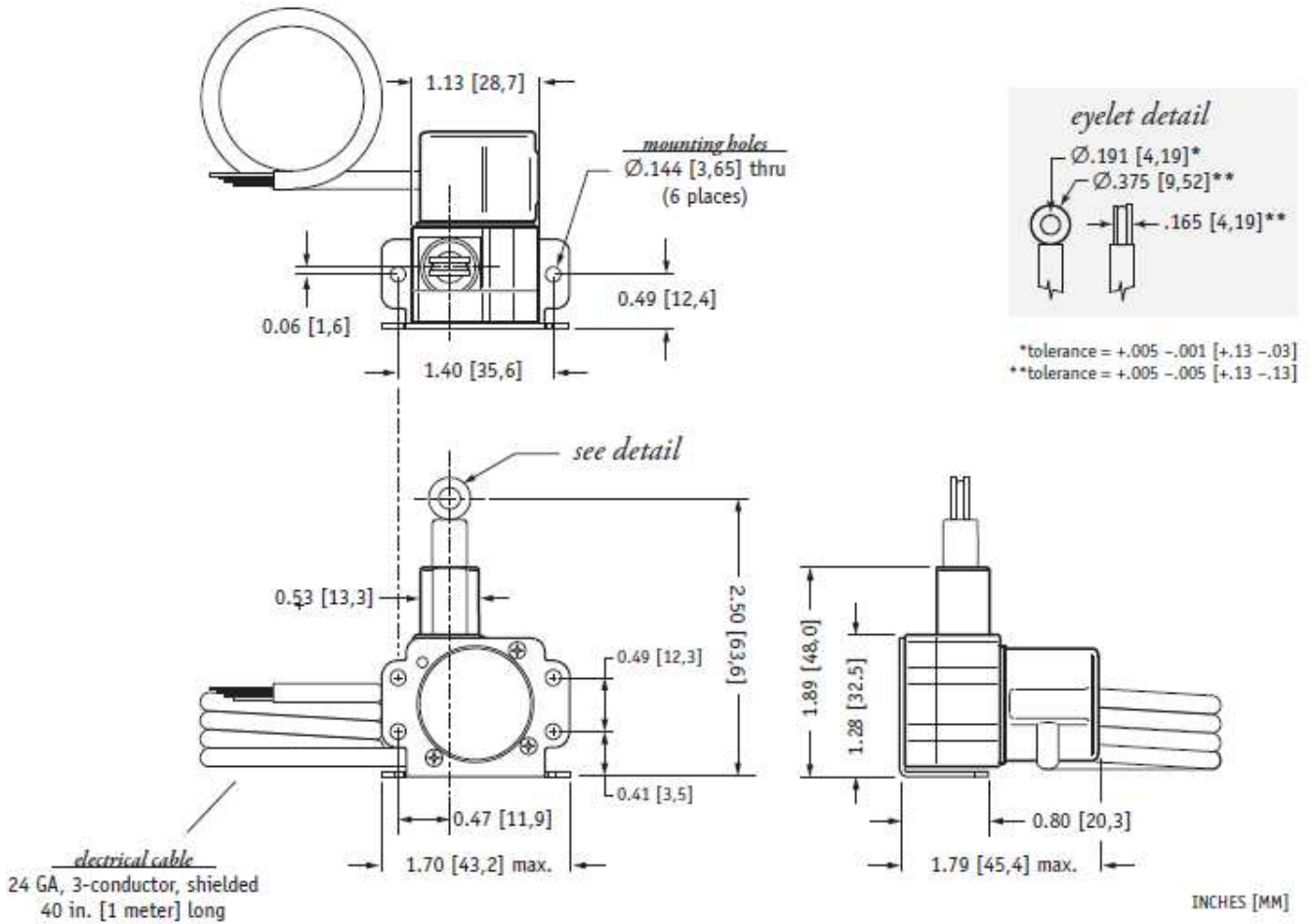

SM2

Miniature String Pot | Voltage Divider Output

Outline Drawing (w/o bracket):

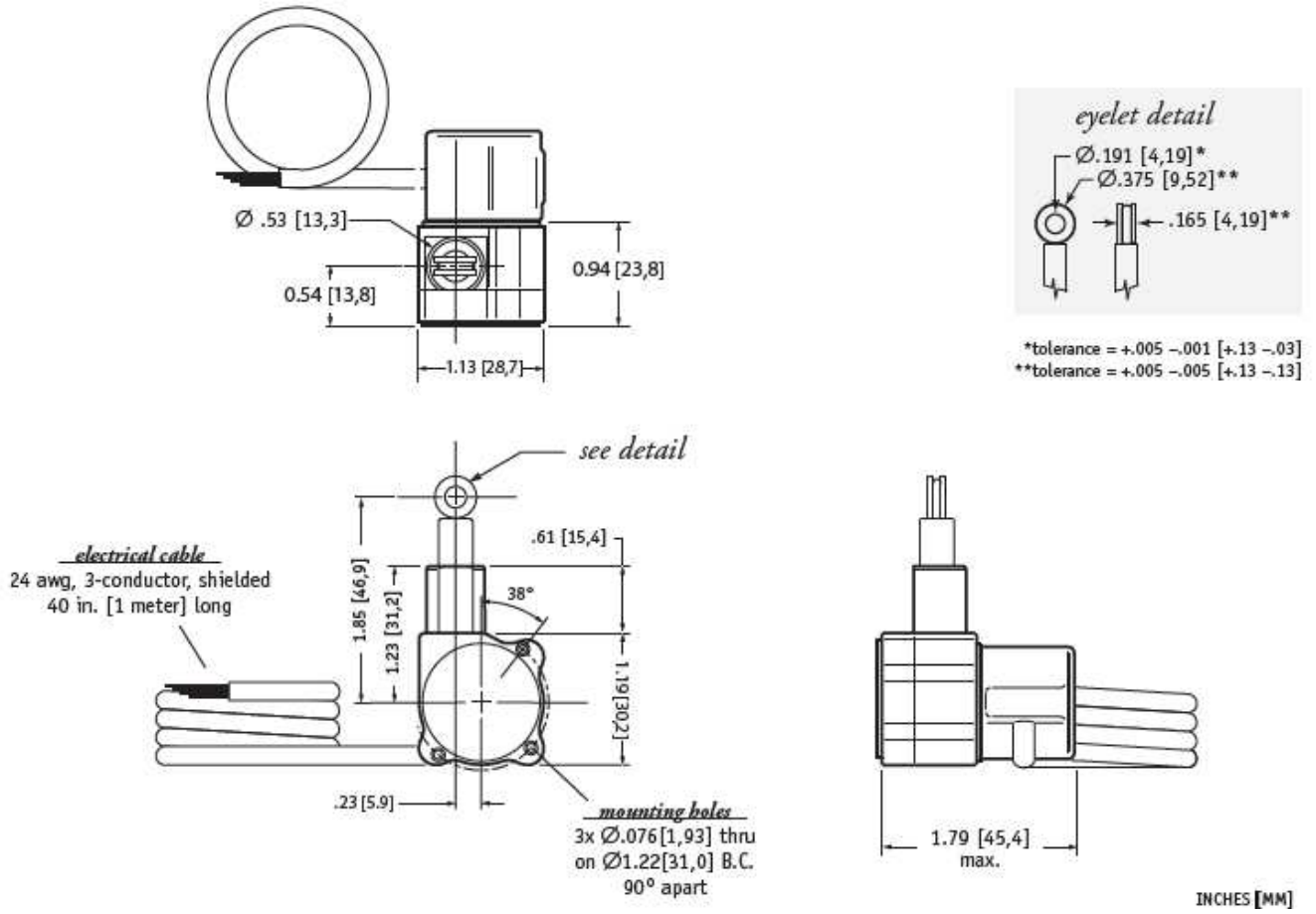

Mounting Options Details:

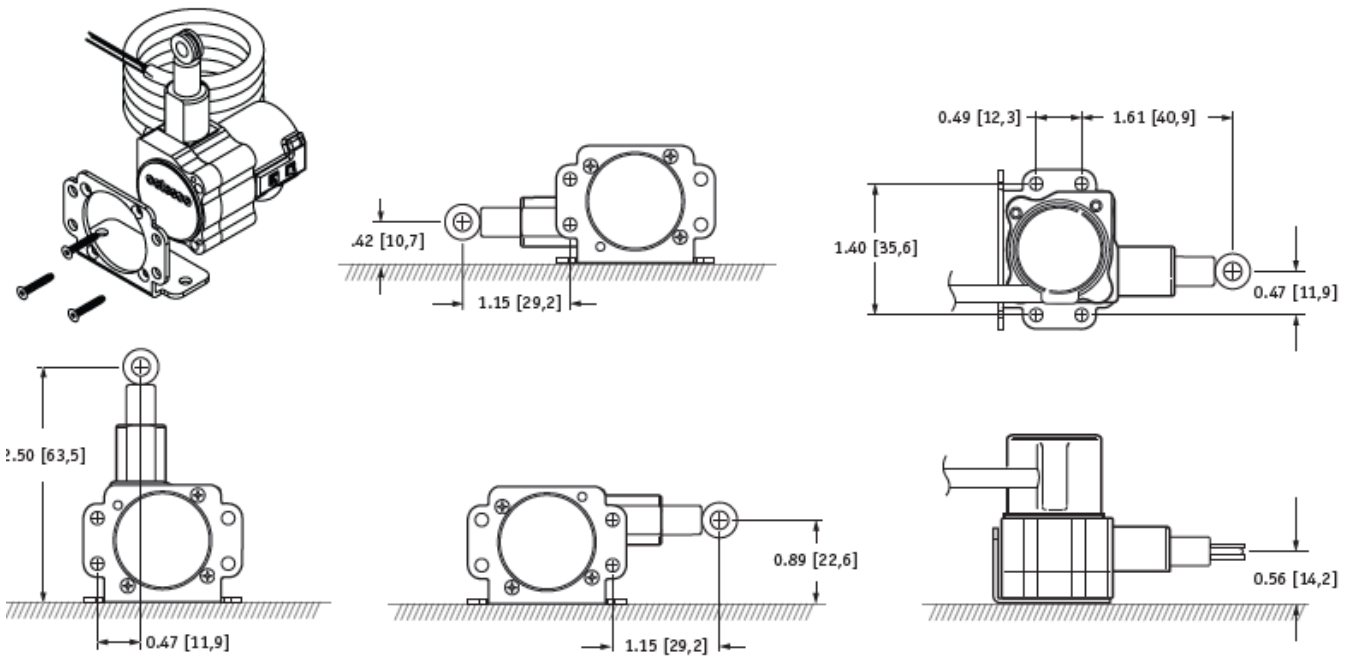

SM2

Miniature String Pot | Voltage Divider Output

Ordering Information:



includes sensor & mounting bracket.

Order No.	full stroke range	accuracy (% of f.s.)	cycle life
SM2-2	2.375 in (60 mm)	1.00%	2.5M cycles
SM2-7	7.5 in (191 mm)	0.25%	500K cycles
SM2-12	12.5 in (318 mm)	0.25%	500K cycles
SM2-25	25 in (635 mm)	0.25%	250K cycles

[CLICK HERE >](#)
CONNECT WITH A SPECIALIST

NORTH AMERICA
Tel +1 800 522 6752

EUROPE
Tel +31 73 624 6999

ASIA
Tel +86 0400 820 6015

te.com/sensors

TE Connectivity, TE, TE Connectivity (logo) and Every Connection Counts are trademarks. All other logos, products and/or company names referred to herein might be trademarks of their respective owners.

The information given herein, including drawings, illustrations and schematics which are intended for illustration purposes only, is believed to be reliable. However, TE Connectivity makes no warranties as to its accuracy or completeness and disclaims any liability in connection with its use. TE Connectivity's obligations shall only be as set forth in TE Connectivity's Standard Terms and Conditions of Sale for this product and in no case will TE Connectivity be liable for any incidental, indirect or consequential damages arising out of the sale, resale, use or misuse of the product. Users of TE Connectivity products should make their own evaluation to determine the suitability of each such product for the specific application.

© 2021 TE Connectivity Corporation. All Rights Reserved.

Version # 08/2023



Mouser Electronics

Authorized Distributor

Click to View Pricing, Inventory, Delivery & Lifecycle Information:

[TE Connectivity:](#)

[SM2-7](#)