



SKJ

Cable Actuated Sensor J1939 CANBus Output Signal

The SKJ is an easily customizable linear position sensor for applications from mobile construction equipment to hydraulic lift tables and anything else in between. Available in both 250 and 400-inch stroke ranges, this model offers ease-of-use, compact design and user flexibility. Need to mount it upside down? Simply rotate its stainless mounting bracket to where you want it. Need the electrical connector to point in a different direction? Just rotate the rear cover to point the connector to the desired direction.

Our unique electronic circuitry and an extremely durable spring-loaded stainless steel measuring cable deliver an accurate reliable “absolute” position feedback signal over the entire stroke.

FEATURES

- Flexibility - Every unit offers linear position up to 400” (10m) providing flexibility to work across a wide range of aerial applications. This off-the-shelf series offers a wide selection of industry standard output signals (4-20mA, 0-10Vdc, CANOpen and J1939 CANbus).
- Ease of use - A compact design, a stainless-steel mounting bracket for multiple installation options and an easily-adjustable measuring cable orientation make this sensor easy to install and manage.
- Superior engineering - TE provides engineering partnership to customize for specific applications. There is also an option to have two sensors elements in the same package with no additional space requirement. This provides fail-safe security for aerial applications.

APPLICATIONS

Accurate measurement in customized applications industrial and commercial transportation like:

- Fork lifts
- Telescopic arms
- Boom lifts
- Scissor lifts

Linear Position to 400 inches (10 m) Compact Design • Simple To Install User Adjustable Measuring Cable orientation

Specifications

Stroke Range Options	250 inches (6.4 m), 400 inches (10.2 m)
Accuracy	0.35% FS.
Repeatability	0.05% FS.
Resolution	12-bit
Input Voltage	10-36 VDC
Input Current	100 mA, max.
Measuring Cable	0.031-inch dia. bare stainless steel
Maximum Cable Velocity	60 inches per second
Maximum Cable Acceleration	5 g
Measuring Cable Tension	23 oz. (6.4 N) ±40%
Sensor	plastic-hybrid precision potentiometer
Cycle Life	≥ 250,000
Electrical Connection	M12 connector, mating plug included
Enclosure	glass-filled polycarbonate
Environmental	IP67
Operating Temperature	-40° to 185° F (-40° to 85° C)

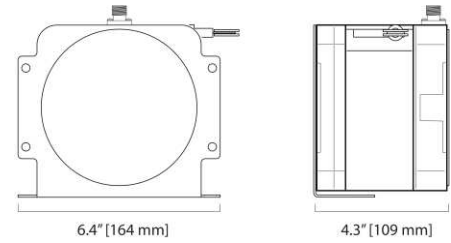

CANopen Specifications

Communication Profile	CANbus SAE J1939
Protocol	Proprietary B
Node ID	Adjustable via dipswitch (0-63), default set to 0
Baud Rate Options	125K (default), 250K, 500K
Data Rate	5ms (default), 20ms, 50ms, 100ms

Output Signal

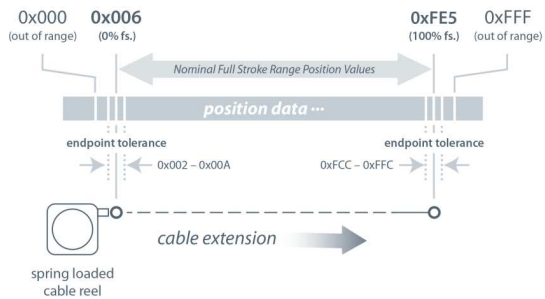

Outline Drawing

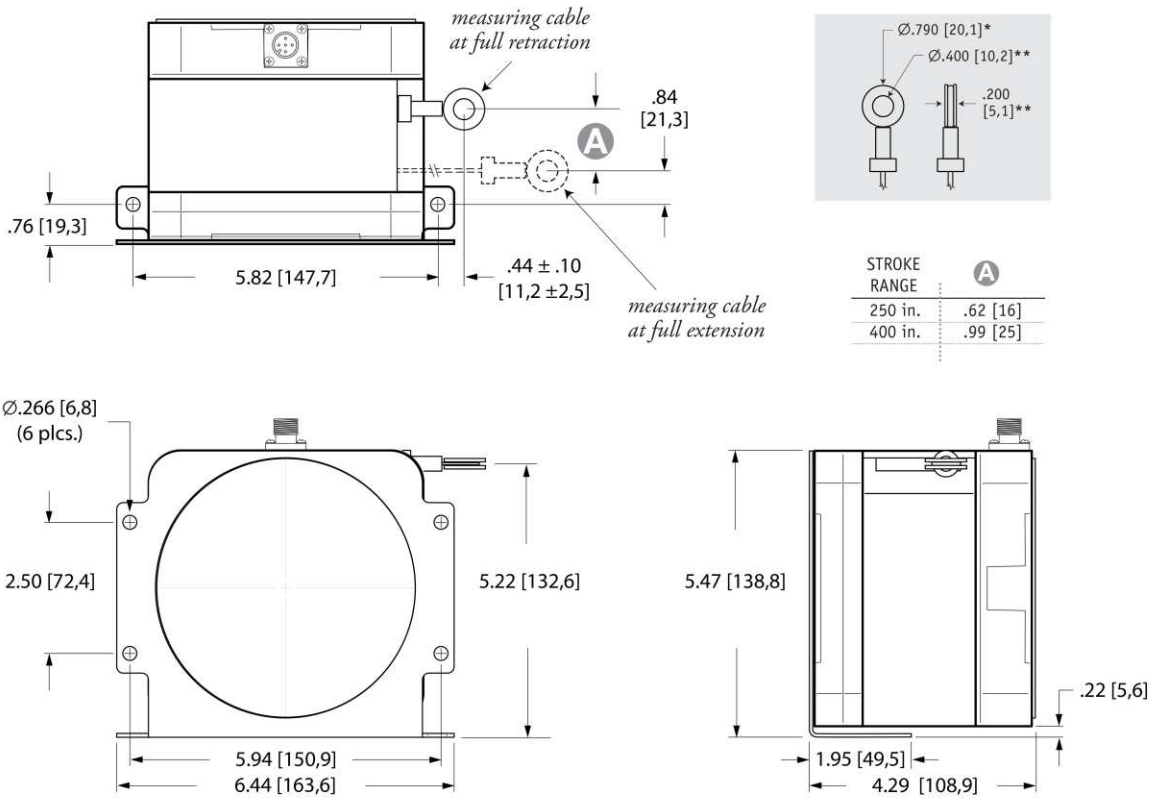

DIMENSIONS ARE IN INCHES [MM]
 tolerances are 0.04 IN. [1,0 MM] unless otherwise noted.

* tolerance = +.005 -0.01 [+0,1 -0,0]
 ** tolerance = +.005 -0.005 [+0,1 -0,1]

Mounting Options

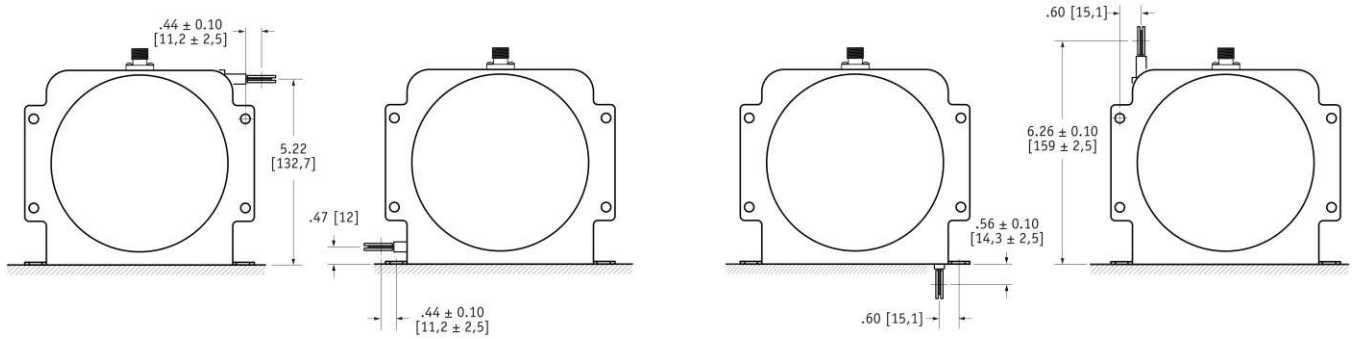

To change cable exit direction: simply remove the 4 bracket mounting screws and rotate sensor body to desired direction.

To change electrical connector orientation: remove the 4 rear screws and carefully remove the rear cover and rotate cover.

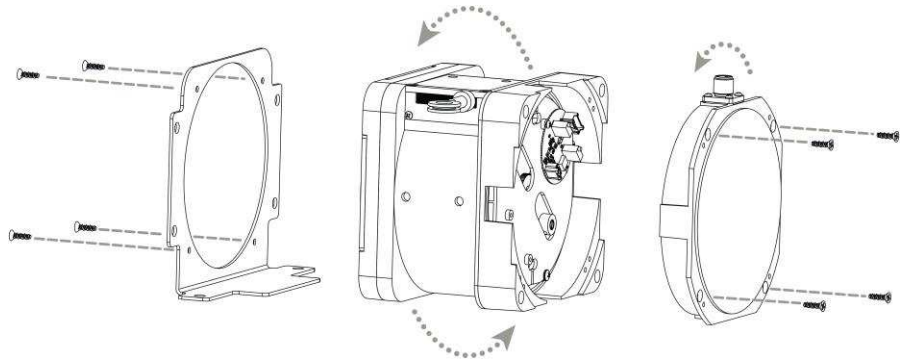

Ordering Information

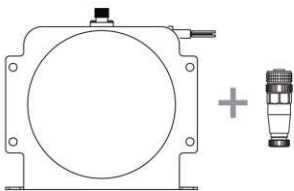

Part Number	full stroke range	accuracy	max. acceleration	measuring cable tension (± 40%)
SKJ-250-4	250 in (6.4 m)	.35%	5 g	23 oz. (6,4 N)
SKJ-400-4	400 in (10.2 m)	.35%	5 g	23 oz. (6,4N)

includes mounting bracket & mating connector.

Optional Cordsets

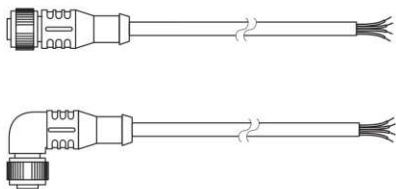

Part Number	length	wire size	connector
9036810-0030	13 ft (4 m)	22 AWG (.34mm ²)	straight 5-pin M12
9036810-0031	13 ft (4 m)	22 AWG (.34mm ²)	90° 5-pin M12

Electrical Connection

Output Signal	pin	pin - color
n/c	1	1 - brown
10..36 Vdc	2	2 - white
common	3	3 - blue
CAN - High	4	4 - black
CAN - Low	5	5 - green/yellow

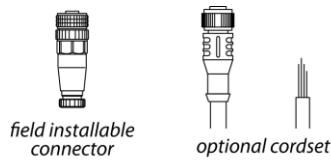

Field Installable Connector

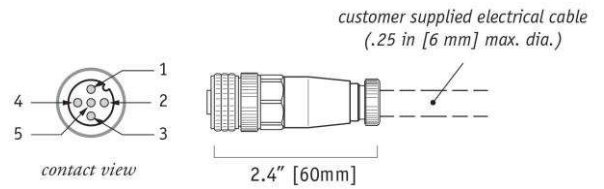

Position Data Overview

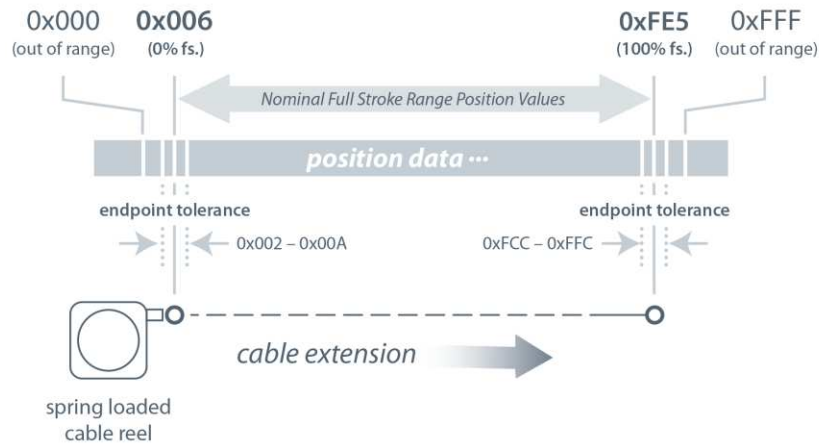

I/O Format

Interframe Space	Start of Frame	Identifier	RTR Bit	Control Field	Data Field	CRC Sequence	CRC Delimiter	Ack Slot	Ack Delimiter	End of Frame	Interframe Space
1 bit	29 bits	1 bit	6 bits	0-8 bytes	15 bits	1 bit	1 bit	1 bit	7 bits	3 bits	

Identifier

Message Priority	Future Use		J1939 Reference Proprietary B								Data Field Type*						Not Used		Node ID**											
Example -	1	0	0	0	0	1	1	1	1	1	1	1	1	0	1	0	1	0	0	1	1	0	0	1	1	1	1	1	1	1
Identifier Bit No. -	28	27	26	25	24	23	22	21	20	19	18	17	16	15	14	13	12	11	10	9	8	7	6	5	4	3	2	1	0	
Hex Value -	0				F				F				5			3			3		F									

*Sensor field data can be factory set to customer specific value. **Customer defined, set via Dips 1-6. Bit values shown for example only, see Address Setting below.

Data Field

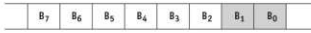

Current Measurement Count

The Current Measurement Count (CMC) is the output data that indicates the present position of the measuring cable. The CMC is a 12-bit value that occupies bytes B₀ and B₁ of the data field. B₀ is the LSB (least significant byte) and B₁ is the MSB (most significant byte).

The CMC starts at 0x006 with the measuring cable fully retracted and continues upward to the end of the stroke range stopping at 0xFE5. This holds true for all ranges.

Converting CMC to Linear Measurement

To convert the current measurement count to inches or millimeters, simply divide the count by 4061 (total counts over the range) and then multiply that value by the full stroke range:

$$\left(\frac{\text{CMC} - 6}{4063} \right) \times \text{full stroke range}$$

Sample Conversion:

If the full stroke range is 250 inches and the current position is 0x4FF (1279 Decimal) then,

$$\left(\frac{1279 - 6}{4061} \right) \times 250 = 78.8 \text{ inches}$$



Error Flags

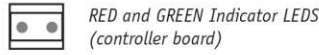

0x00 (GREEN - ON, RED - OFF) indicates the sensor is operating within normal calibrated limits.

0x33, 0x55, 0xAA, 0xCC (RED or GREEN - FLASHING) indicates sensor is at or beyond its calibrated measurement range. Should any of these conditions occur within calibrated range, return unit to factory for evaluation or service.

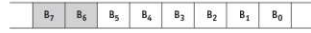

Velocity

Data in bytes B₇ - B₆ is the change in the CMC (current measurement count) over a 100 msec time period. This data can then be used to calculate velocity in a post processing operation.

B ₇ - B ₆ HEX (Decimal)	^{max} _{reverse} velocity / ^{max} _{forward} velocity	Velocity (cts./100 msec.)
0x000 (0)		- 2047 counts
0x7FF (2047)		"0" counts (no change)
0xFFF (4095)		2047 counts

Velocity Calculation

$$\left(\frac{\text{count change} - 2047}{.1 \text{ sec. time period}} \right) \times \left(\frac{\text{full stroke range}}{4063} \right)$$

Sample Calculations

Cable Extension (positive direction):

B₇..B₆ = 0x8D3 (2259Dec), full stroke = 250 in.

$$\left(\frac{2259 - 2047}{.1 \text{ sec}} \right) \times \left(\frac{250 \text{ in.}}{4063} \right) = 130.45 \text{ in. / sec.}$$

Cable Retraction (negative direction):

B₇..B₆ = 0x7D0 (2000Dec), full stroke = 250 in.

$$\left(\frac{2000 - 2047}{.1 \text{ sec}} \right) \times \left(\frac{250 \text{ in.}}{4063} \right) = - 28.92 \text{ in. / sec.}$$

Baud, Node ID and Data Rate

Baud Rate, Node ID and Data Rate settings are set via dip switch found on the internal controller board. To gain access to the controller board, remove the 4 cover attaching screws and carefully separate the sensor cover from the main body. Be careful not to damage the small gage wires that connect the controller board to the connector mounted directly to the rear cover.

Follow the instructions below for desired settings and reinstall sensor cover.



node ID		SW1	SW2	SW3	SW4	SW5	SW6
Dec.	Hex	(2 ⁰)	(2 ¹)	(2 ²)	(2 ³)	(2 ⁴)	(2 ⁵)
0	0x00	off	off	off	off	off	off
1	0x01	on	off	off	off	off	off
2	0x02	off	on	off	off	off	off
3	0x03	on	on	off	off	off	off
...
62	0x3E	off	on	on	on	on	on
63	0x3F	on	on	on	on	on	on

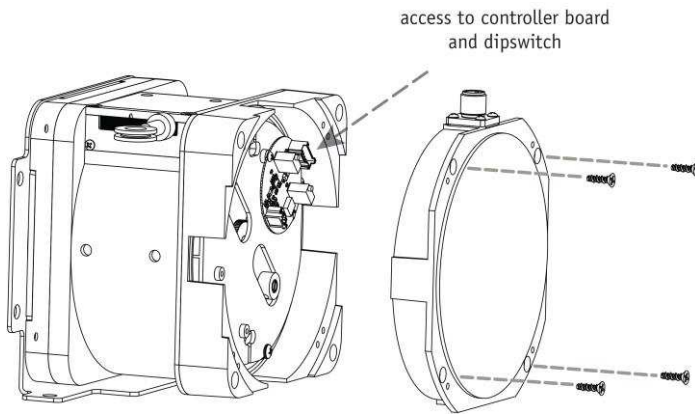
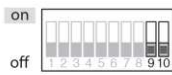

BAUD rate options	SW7	SW8
125 kbps	off	off
250 kbps	on	off
500 kbps	off	on

Data Rate options	SW9	SW10
5 ms	off	off
20 ms	on	off
50 ms	off	on
100 ms	on	on

NORTH AMERICA

Measurement Specialties, Inc.,
 a TE Connectivity Company
 Phone: +1-800-522-6752
 Email: customercare.hmpt@te.com

EUROPE

MEAS Deutschland GmbH (Europe)
 a TE Connectivity Company
 Phone: +31 73 624 6999
 Email: customercare.dtm@te.com

ASIA

Measurement Specialties (China), Ltd.,
 a TE Connectivity Company
 Phone: +86-400-820-6015
 Email: customercare.shzn@te.com

TE.com/sensors

Measurement Specialties, TE Connectivity, TE Connectivity (logo) and EVERY CONNECTION COUNTS are trademarks. All other logos, products and/or company names referred to herein might be trademarks of their respective owners.

The information given herein, including drawings, illustrations and schematics which are intended for illustration purposes only, is believed to be reliable. However, TE Connectivity makes no warranties as to its accuracy or completeness and disclaims any liability in connection with its use. TE Connectivity's obligations shall only be as set forth in TE Connectivity's Standard Terms and Conditions of Sale for this product and in no case will TE Connectivity be liable for any incidental, indirect or consequential damages arising out of the sale, resale, use or misuse of the product. Users of TE Connectivity products should make their own evaluation to determine the suitability of each such product for the specific application.

© 2019 TE Connectivity Ltd. family of companies All Rights Reserved.

Mouser Electronics

Authorized Distributor

Click to View Pricing, Inventory, Delivery & Lifecycle Information:

[TE Connectivity:](#)

[SKJ-400-4](#)