

FEATURE

Low speed switching

MAXIMUM RATINGS (T_a=25°C unless otherwise noted)

Symbol	Parameter	Value	Unit
V _{CB0}	Collector-Base Voltage	-40	V
V _{CEO}	Collector-Emitter Voltage	-30	V
V _{EBO}	Emitter-Base Voltage	-6	V
I _C	Collector Current -Continuous	-3	A
P _C	Collector Power Dissipation	0.5	W
R _{θJA}	Thermal Resistance, Junction to Ambient	250	°C/W
T _J , T _{stg}	Operation Junction and Storage Temperature Range	-55~150	°C

SOT-89

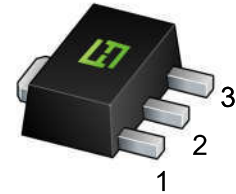

- 1. BASE
- 2. COLLECTOR
- 3. EMITTER

MARKING: B772

ELECTRICAL CHARACTERISTICS (T_a=25°C unless otherwise specified)

Parameter	Symbol	Test conditions	Min	Typ	Max	Unit
Collector-base breakdown voltage	V _{(BR)CBO}	I _C =-100μA, I _E =0	-40			V
Collector-emitter breakdown voltage	V _{(BR)CEO}	I _C = -10mA, I _B =0	-30			V
Emitter-base breakdown voltage	V _{(BR)EBO}	I _E = -100μA, I _C =0	-6			V
Collector cut-off current	I _{CBO}	V _{CB} = -40V, I _E =0			-1	μA
Collector cut-off current	I _{CEO}	V _{CE} =-30V, I _B =0			-10	μA
Emitter cut-off current	I _{EBO}	V _{EB} =-6V, I _C =0			-1	μA
DC current gain	h _{FE}	V _{CE} = -2V, I _C = -1A	60		400	
Collector-emitter saturation voltage	V _{CE(sat)}	I _C =-2A, I _B = -0.2A			-0.5	V
Base-emitter saturation voltage	V _{BE(sat)}	I _C =-2A, I _B = -0.2A			-1.5	V
Transition frequency	f _T	V _{CE} = -5V, I _C =-0.1A f =10MHz	50			MHz

CLASSIFICATION OF h_{FE}

Rank	R	O	Y	GR
Range	60-120	100-200	160-320	200-400

Typical Characteristics

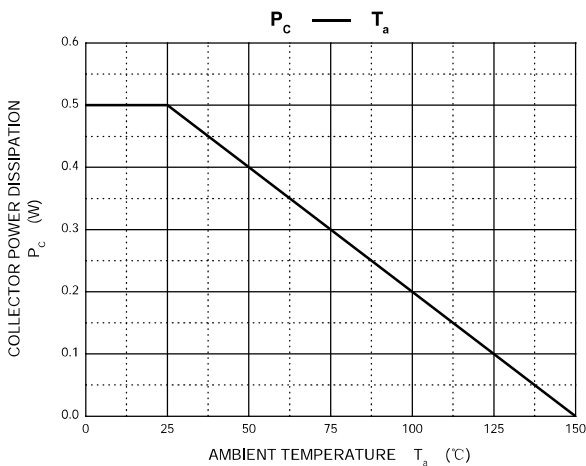
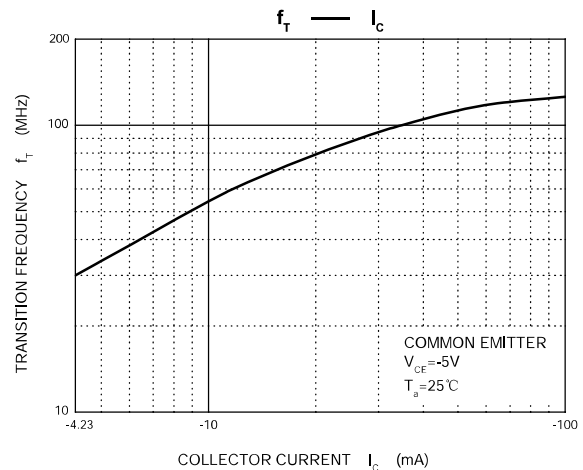
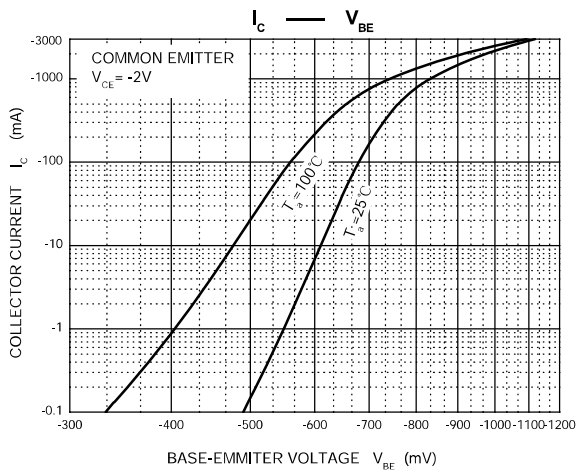
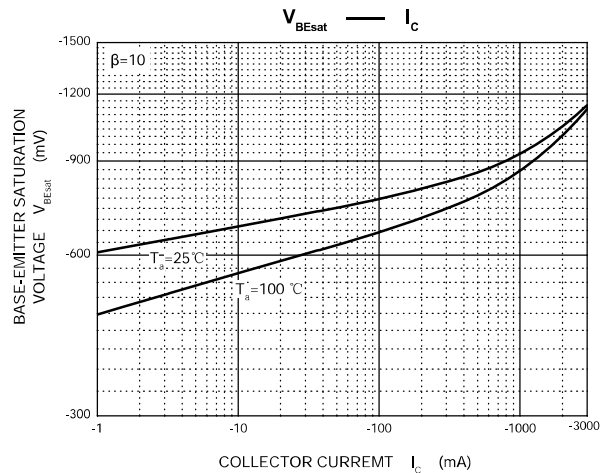
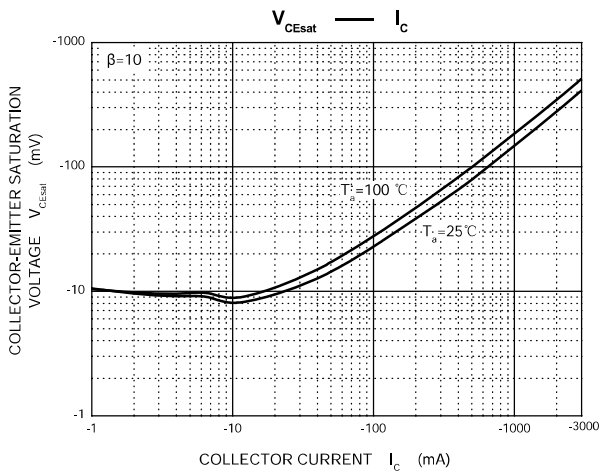
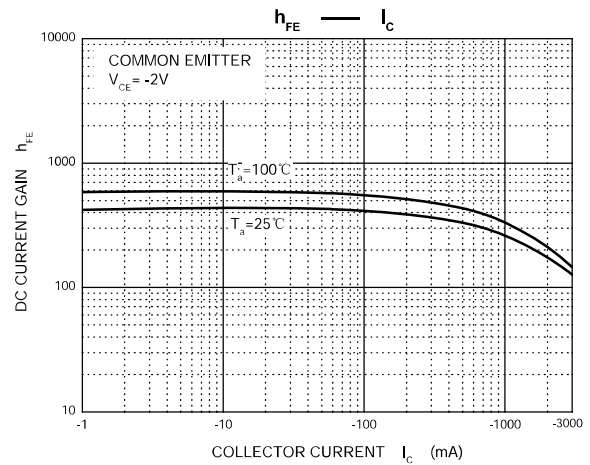
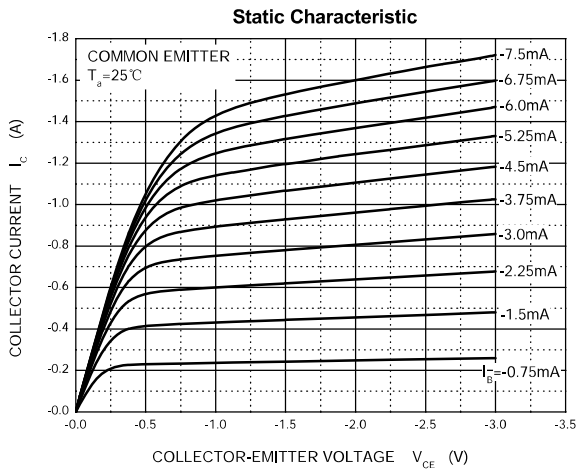

SOT-89 Package Outline Dimensions

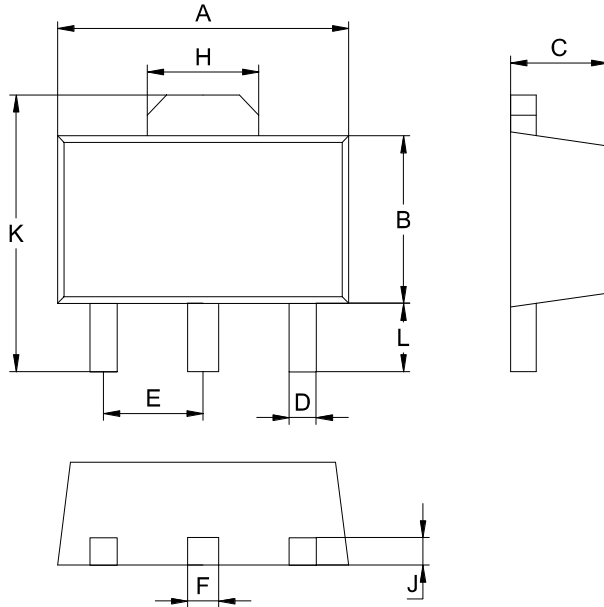

SOT-89		
Dim	Min	Max
A	4.30	4.70
B	2.20	2.70
C	1.30	1.70
D	0.30	0.60
E	1.40	1.60
F	0.30	0.60
H	1.40	1.80
J	0.30	0.60
L	0.90	1.10
K	3.75	4.35
All Dimensions in mm		

SOT-89 Suggested Pad Layout

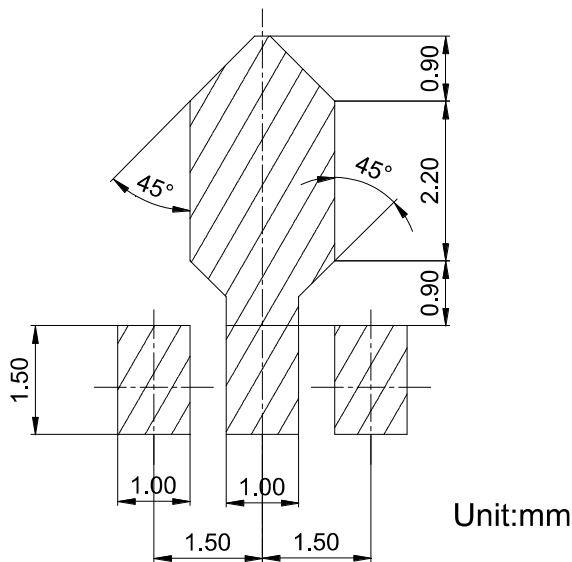

Unit:mm