

<b>Order Code</b>	<b>TCK-073</b>
<b>Inductance</b> (each winding)	305 $\mu\text{H} \pm 35\%$ (at 100 kHz / 100 mV)
<b>Impedance</b> (DCR)	20 mOhm max.
<b>Rated Current</b>	11.3 A max.
<b>Rated Voltage</b>	500 VDC max. (between windings)
<b>Operating Temperature</b>	-40°C to +105°C

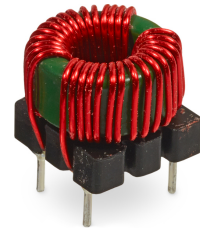

### Impedance Curve

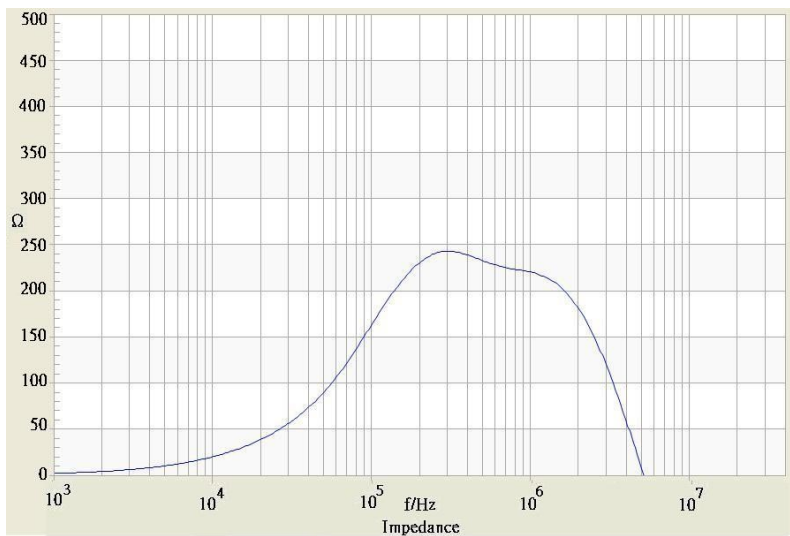

### Outline Dimensions

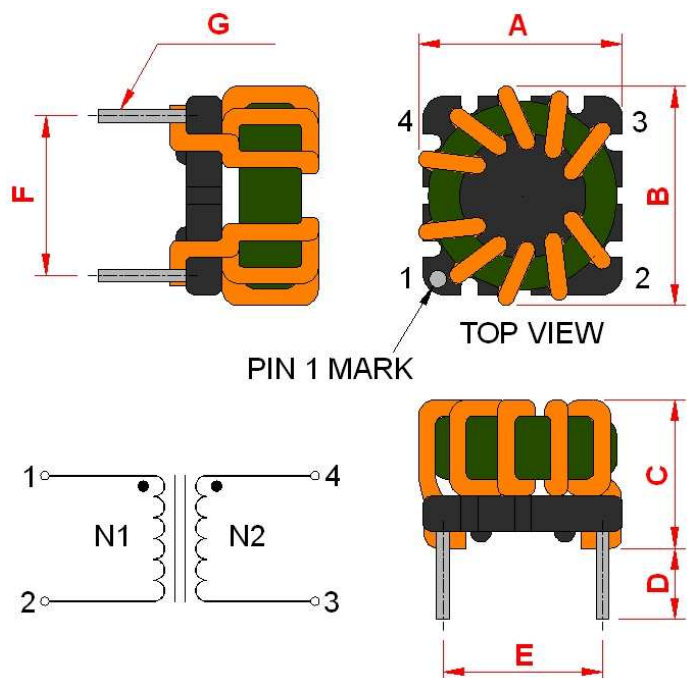

Dimensions [mm]	
<b>A</b>	16.0 max.
<b>B</b>	16.0 max.
<b>C</b>	15.0 max.
<b>D</b>	4.0 $\pm 0.3$
<b>E</b>	10.0 $\pm 0.3$
<b>F</b>	7.4 $\pm 0.3$
<b>G</b>	$\varnothing 0.8$