

# High Isolation Power Transformer

Shaped Core Platform SMD



- Flyback Converter Transformer
- Designed for Broadcom ACPL-32JT and ACPL-302J IGBT Gate Driver
- Compact and cost effective industrial design
- PH9363NL: Basic insulation, 2.8mm creepage
- PH9496NL: Basic insulation, 6.2mm creepage
- PH0416NL: Reinforced insulation, 8.3mm creepage



Electrical Specifications @ 25°C - Operating Temperature -40°C to +125°C							
Part Number	Inductance (Pri) ( $\mu\text{H} \pm 10\%$ )	Primary Current (A MAX)	Inductance (Sec) ( $\mu\text{H} \pm 10\%$ )	DCR (Sec) ( $\Omega$ MAX)	Leakage Inductance (Pri) ( $\mu\text{H}$ Max)	Turns Ratio	Isolated Voltage (Vrms)
PH9363NL	60	1.0	240	0.60	3.0	1:2	2500 / 1 minute
PH9496NL	52	1.7	332	0.22	1.2	1:2.53	2500 / 1 minute
PH0416NL	43	1.0	172	1.2	2	1:2	5000 / 1 minute

**Notes:**

1. These transformers are approved by Broadcom to deliver a isolated 18V IGBT drive voltage from a 8V-18V source.
2. Optional Tape & Reel packing can be ordered by adding a "T" suffix to the part number.
3. Other turns ratios and isolation levels available on request.
4. The rated primary current is based on a peak flux density of 220mT.

## Mechanical

## Schematic

### PH9363NL

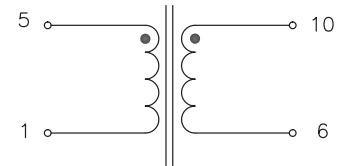
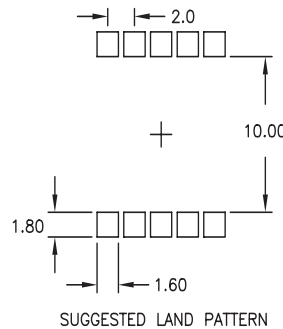
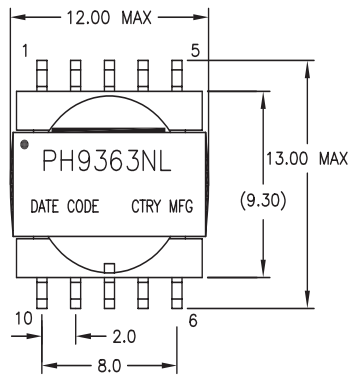

Weight .....1.4grams  
 Tape & Reel .....500/reel  
 Tray .....100/tray

**Dimensions: mm**

Unless otherwise specified,  
 all tolerances are  $\pm 0.25$

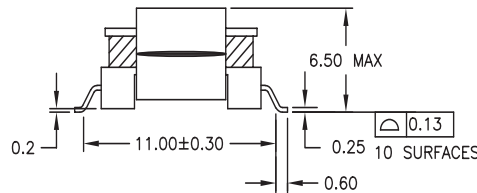
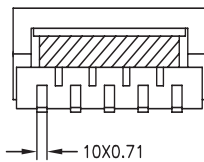

FINAL OUTLINE

# High Isolation Power Transformer

Shaped Core Platform SMD



## PH9496NL

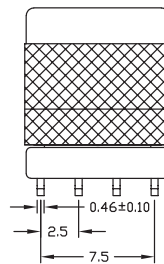
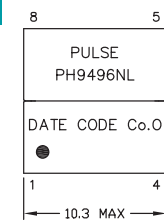

### Mechanical

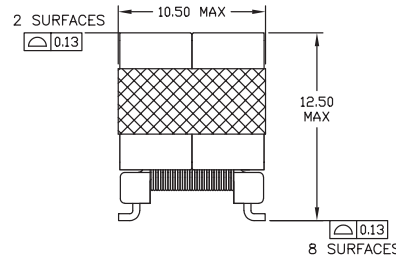
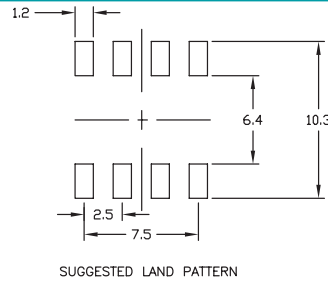

### Schematic

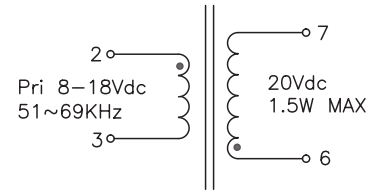

Weight .....2.6grams  
Tape & Reel .....175/reel  
Tray .....90/tray  
Dimensions: mm

Unless otherwise specified,  
all tolerances are±0.25

## PH0416NL

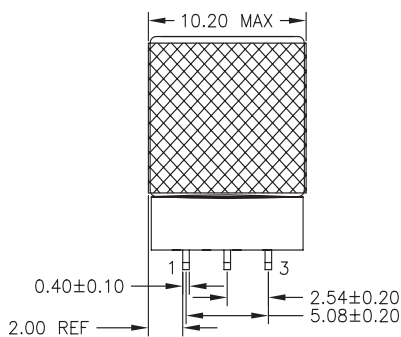

### Mechanical

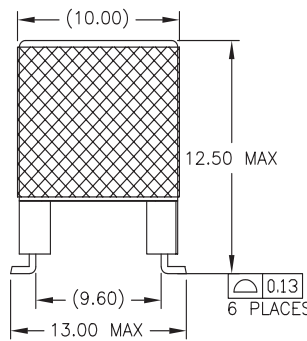
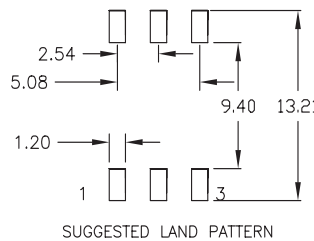

### Schematic

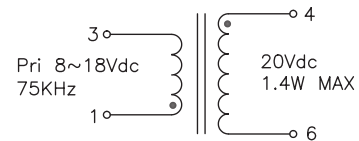

Weight .....2.6grams  
Tape & Reel .....150/reel  
Tray .....80/tray  
Dimensions: mm

Unless otherwise specified,  
all tolerances are±0.25

## For More Information

### Pulse Worldwide Headquarters

15255 Innovation Drive Ste 100  
San Diego, CA 92128  
U.S.A.

### Pulse Europe

Pulse Electronics GmbH  
Am Rottland 12  
58540 Meinerzhagen  
Germany

### Pulse China Headquarters

Pulse Electronics (ShenZhen) CO., LTD  
D708, Shenzhen Academy of  
Aerospace Technology,  
The 10th Keji South Road,  
Nanshan District, Shenzhen,  
P.R. China 518057

### Pulse North China

Room 2704/2705  
Super Ocean Finance Ctr.  
2067 Yan An Road West  
Shanghai 200336  
China

### Pulse South Asia

3 Fraser Street  
0428 DUO Tower  
Singapore 189352

### Pulse North Asia

1F., No.111 Xiyuan Rd  
Zhongli City  
Taoyuan City 32057  
Taiwan (R.O.C)

Tel: 858 674 8100  
Fax: 858 674 8262

Tel: 49 2354 777 100  
Fax: 49 2354 777 168

Tel: 86 755 33966678  
Fax: 86 755 33966700

Tel: 86 21 62787060  
Fax: 86 2162786973

Tel: 65 6287 8998  
Fax: 65 6280 0080

Tel: 886 3 4356768  
Fax: 886 3 4356820

Performance warranty of products offered on this data sheet is limited to the parameters specified. Data is subject to change without notice. Other brand and product names mentioned herein may be trademarks or registered trademarks of their respective owners. © Copyright, 2018. Pulse Electronics, Inc. All rights reserved.

# Mouser Electronics

Authorized Distributor

Click to View Pricing, Inventory, Delivery & Lifecycle Information:

Pulse:

[PH9363NLT](#) [PH0416NLT](#) [PH9496NLT](#)