

# LUXEON C Color Line

Multiple colors, a single focal length

The LUXEON C Color Line is an optically advanced portfolio of Color and White LEDs. Designed for flawless color mixing, LUXEON C Color Line has one focal length for all colors, which provides consistent radiation patterns from secondary optics and maximizes optical efficiency. With low dome design, it keeps effective source size small while still improving light extraction. Designed for smooth color mixing and maximum punch, LUXEON C Color Line is the optimal LED solution for architecture, emergency vehicle lighting and horticulture lighting applications.

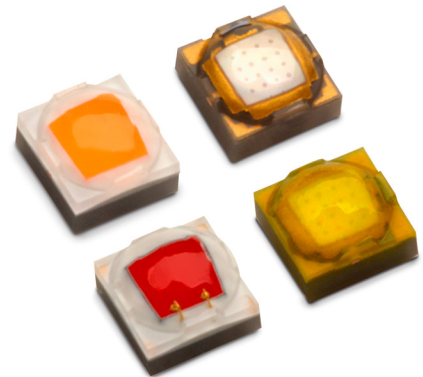

## FEATURES AND BENEFITS

One focal length allows flawless color mixing, maximum optical efficiency and removes halos

Low dome design eliminates trade-offs between flux and source size

Hot tested—removes guesswork for designers

Industry's lowest thermal resistance means greater light output and lower heatsink costs

Small symmetrical 2x2mm<sup>2</sup> package enables dense packing and limits the impact of rotation during reflow

## PRIMARY APPLICATIONS

Architectural

Lamps

– Color Tunable

Specialty Lighting

– Emergency Vehicle

– Horticulture

# Table of Contents

<b>General Product Information</b> .....	<b>2</b>
Product Test Conditions .....	2
Part Number Nomenclature .....	2
Lumen Maintenance .....	2
Environmental Compliance .....	2
<b>Performance Characteristics</b> .....	<b>3</b>
Product Selection Guide .....	3
Optical Characteristics .....	4
Electrical and Thermal Characteristics .....	4
<b>Absolute Maximum Ratings</b> .....	<b>5</b>
<b>Characteristic Curves</b> .....	<b>6</b>
Spectral Power Distribution Characteristics .....	6
Light Output Characteristics .....	7
Forward Current Characteristics .....	13
Radiation Pattern Characteristics .....	16
<b>Product Bin and Labeling Definitions</b> .....	<b>18</b>
Decoding Product Bin Labeling .....	18
Luminous Flux Bins .....	19
Radiometric Power Bins .....	19
Color Bin Definition .....	20
Dominant Wavelength Bins .....	21
Peak Wavelength Bins .....	21
Forward Voltage Bins .....	23
<b>Mechanical Dimensions</b> .....	<b>24</b>
<b>Reflow Soldering Guidelines</b> .....	<b>25</b>
JEDEC Moisture Sensitivity .....	25
Solder Pad Design .....	26
<b>Packaging Information</b> .....	<b>26</b>
Pocket Tape Dimensions .....	26
Reel Dimensions .....	27

# General Product Information

## Product Test Conditions

LUXEON C LEDs are tested and binned with a DC drive current of 350mA at a junction temperature,  $T_j$ , of 85°C.

## Part Number Nomenclature

Part numbers for LUXEON C Colors follow the convention below:

L 1 C 1 – **A A A** 1 0 0 0 0 0 0 0 0 0

Where:

**A A A** – designates color (FRD=Far Red, RED=Red, RNG=Red-Orange, AMB=Amber, PCA=PC Amber, MNT=Mint, LME=Lime, GRN=Green, CYN=Cyan, BLU=Blue, RYL=Royal Blue)

Therefore, the following part number is used for a LUXEON C Red:

L 1 C 1 – **R E D** 1 0 0 0 0 0 0 0 0 0

Part numbers for LUXEON C White follow the convention below:

L 1 C 1 – **A A B B** 0 0 0 0 0 0 0 0 0 0

Where:

**A A** – designates nominal CCT (27= 2700K, 30=3000K, 40=4000K, 57=5700K)

**B B** – designates minimum CRI (70=70CRI, 80=80CRI, 90=90CRI)

Therefore, the following part number is used for LUXEON C White at 4000K 70CRI:

L 1 C 1 – **4 0 7 0** 0 0 0 0 0 0 0 0 0 0

## Lumen Maintenance

Please contact your local Sales Representative or Lumileds Technical Solutions Manager for more information about the long-term performance of this product.

## Environmental Compliance

Lumileds LLC is committed to providing environmentally friendly products to the solid-state lighting market. LUXEON C is compliant to the European Union directives on the restriction of hazardous substances in electronic equipment, namely the RoHS Directive 2011/65/EU and REACH Regulation (EC) 1907/2006. Lumileds LLC will not intentionally add the following restricted materials to its products: lead, mercury, cadmium, hexavalent chromium, polybrominated biphenyls (PBB) or polybrominated diphenyl ethers (PBDE).

# Performance Characteristics

## Product Selection Guide

Table 1a. Product performance of LUXEON C Colors at 350mA, T<sub>j</sub>=85°C.

COLOR	DOMINANT OR PEAK WAVELENGTH <sup>[1]</sup> (nm)		LUMINOUS FLUX (lm) OR RADIOMETRIC POWER <sup>[2]</sup> (mW)		PART NUMBER
	MINIMUM	MAXIMUM	MINIMUM	TYPICAL	
Far Red	720	750	190	230	L1C1-FRD1000000000
Red	624	634	35	39	L1C1-RED1000000000
Red-Orange	614	624	45	52	L1C1-RNG1000000000
Amber	585	600	20	30	L1C1-AMB1000000000
PC Amber	-	-	80	94	L1C1-PCA1000000000
Mint	-	-	140	152	L1C1-MNT1000000000
Lime	-	-	140	152	L1C1-LME1000000000
Green	520	540	90	97	L1C1-GRN1000000000
Cyan	490	510	65	72	L1C1-CYN1000000000
Blue	465	485	25	37	L1C1-BLU1000000000
Royal Blue	440	460	480	532	L1C1-RYL1000000000

**Notes for Table 1a:**

- Lumileds maintains a tolerance of ±6.5% on luminous flux measurements. PC Amber, Mint and Lime are binned by chromaticity coordinates. Far Red and Royal Blue are binned by peak wavelength. All other colors are binned by dominant wavelength.
- Far Red and Royal Blue are binned by radiometric power. All other colors are binned by luminous flux.

Table 1b. Product performance of LUXEON C White at 350mA, T<sub>j</sub>=85°C.

NOMINAL CCT	MINIMUM CRI	LUMINOUS FLUX (lm)		TYPICAL LUMINOUS EFFICACY (lm/W)	PART NUMBER
		MINIMUM	TYPICAL		
4000K	70	100	116	121	L1C1-4070000000000
5700K	70	100	118	124	L1C1-5770000000000
2700K	80	90	94	98	L1C1-2780000000000
3000K	80	90	102	106	L1C1-3080000000000
4000K	80	100	113	117	L1C1-4080000000000
5700K	90	80	93	94	L1C1-5790000000000

**Notes for Table 1b:**

- Lumileds maintains a tolerance of ±2 on CRI and ±6.5% on luminous flux measurements.

## Optical Characteristics

Table 2a. Optical characteristics for LUXEON C Colors at 350mA, T<sub>j</sub>=85°C.

PART NUMBER	TYPICAL SPECTRAL HALF-WIDTH <sup>[1]</sup> (nm)	TYPICAL TEMPERATURE COEFFICIENT OF DOMINANT OR PEAK WAVELENGTH (nm/°C)	TYPICAL TOTAL INCLUDED ANGLE <sup>[2]</sup>	TYPICAL VIEWING ANGLE <sup>[3]</sup>
L1C1-FRD1000000000	20	0.06	175°	162°
L1C1-RED1000000000	20	0.06	175°	162°
L1C1-RNG1000000000	20	0.06	175°	162°
L1C1-AMB1000000000	20	0.06	175°	162°
L1C1-PCA1000000000	80	-0.01	175°	150°
L1C1-MNT1000000000	80	-0.01	175°	150°
L1C1-LME1000000000	80	-0.01	175°	150°
L1C1-GRN1000000000	30	0.04	175°	170°
L1C1-CYN1000000000	30	0.03	175°	170°
L1C1-BLU1000000000	20	0.03	175°	170°
L1C1-RYL1000000000	20	0.03	175°	165°

**Notes for Table 2a:**

- Spectral half-width is the spectral bandwidth at 50% of the peak intensity.
- Total angle at which 90% of total luminous flux is captured.
- Viewing angle is the off axis angle from the LED centerline where the luminous intensity is ½ of the peak value.

Table 2b. Optical characteristics for LUXEON C White at 350mA, T<sub>j</sub>=85°C.

PART NUMBER	TYPICAL TOTAL INCLUDED ANGLE <sup>[2]</sup>	TYPICAL VIEWING ANGLE <sup>[3]</sup>
L1C1-xxx0000000000	170°	150°

**Notes for Table 2b:**

- Spectral half-width is the spectral bandwidth at 50% of the peak intensity.
- Total angle at which 90% of total luminous flux is captured.
- Viewing angle is the off axis angle from the LED centerline where the luminous intensity is ½ of the peak value.

## Electrical and Thermal Characteristics

Table 3. Electrical and thermal characteristics for LUXEON C Colors at 350mA, T<sub>j</sub>=85°C.

PART NUMBER	FORWARD VOLTAGE <sup>[1]</sup> (V)			TYPICAL TEMPERATURE COEFFICIENT OF FORWARD VOLTAGE <sup>[2]</sup> (mV/°C)	TYPICAL THERMAL RESISTANCE — JUNCTION TO SOLDER PAD (°C/W)
	MINIMUM	TYPICAL	MAXIMUM		
L1C1-FRD1000000000	1.50	1.73	2.30	-1.7	2.8
L1C1-RED1000000000	1.75	2.00	2.50	-1.6	2.8
L1C1-RNG1000000000	1.75	2.05	2.50	-1.6	2.8
L1C1-AMB1000000000	1.75	2.05	2.50	-2.0	2.8
L1C1-PCA1000000000	2.50	2.75	3.50	-1.7	3.0
L1C1-MNT1000000000	2.50	2.75	3.50	-2.7	2.8
L1C1-LME1000000000	2.50	2.75	3.50	-2.7	2.8
L1C1-GRN1000000000	2.50	2.55	3.50	-2.4	3.5
L1C1-CYN1000000000	2.50	2.60	3.50	-2.4	3.5
L1C1-BLU1000000000	2.50	2.90	3.50	-2.6	3.5
L1C1-RYL1000000000	2.50	2.75	3.50	-1.7	2.8
L1C1-xxx0000000000	2.50	2.75	3.50	-1.7	2.8

**Notes for Table 3:**

- Lumileds maintains a tolerance of ±0.06V on forward voltage measurements.
- Measured between 25°C and 85°C.

# Absolute Maximum Ratings

Table 4. Absolute maximum ratings for LUXEON C Color Line.

PARAMETER	FAR RED	RED, RED-ORANGE AMBER AND PC AMBER	GREEN, CYAN, BLUE AND ROYAL BLUE	MINT, LIME AND WHITE
DC Forward Current <sup>[1,2]</sup>	700mA	1050mA	1050mA	1225mA
Peak Pulsed Forward Current <sup>[1,3]</sup>	875mA	1300mA	1300mA	1500mA
LED Junction Temperature <sup>[1]</sup> (DC & Pulse)	135°C	120°C	135°C	135°C
ESD Sensitivity (ANSI/ESDA/JEDEC JS-001-2012)	Class 3B	Class 3B	Class 3B	Class 3B
LED Storage Temperature	-40°C to 135°C			
Soldering Temperature	JEDEC 020c 260°C			
Allowable Reflow Cycles	3			
Reverse Voltage ( $V_{reverse}$ )	LUXEON C LEDs are not designed to be driven in reverse bias			

**Notes for Table 4:**

1. Proper current derating must be observed to maintain the junction temperature below the maximum allowable junction temperature.
2. Residual periodic variations due to power conversion from alternating current (AC) to direct current (DC), also called "ripple," are acceptable if the following conditions are met:
  - The frequency of the ripple current is 100Hz or higher
  - The average current for each cycle does not exceed the maximum allowable DC forward current
  - The maximum amplitude of the ripple does not exceed the maximum peak pulsed forward current
3. At 10% duty cycle with pulse width of 10ms.

# Characteristic Curves

## Spectral Power Distribution Characteristics

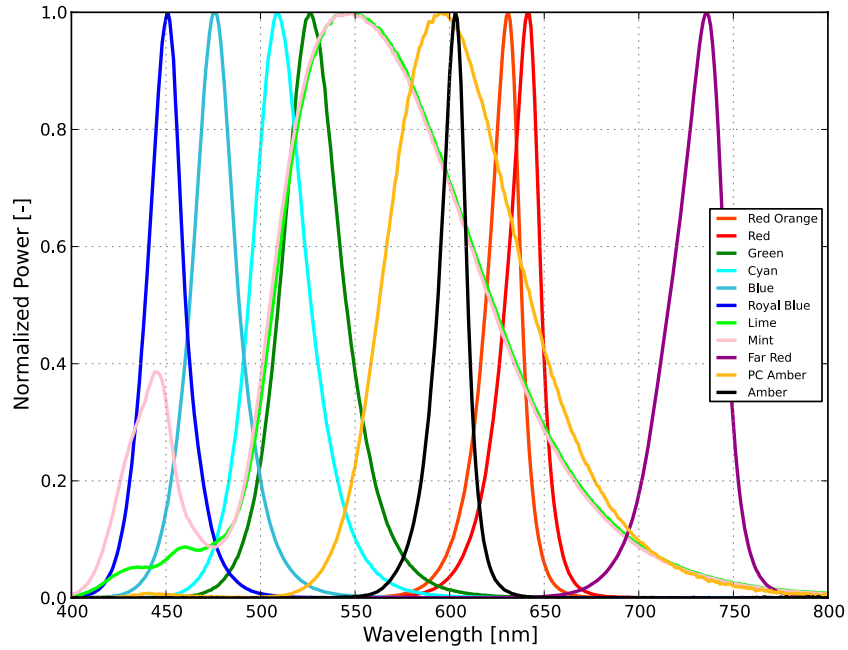

Figure 1a: Typical normalized power vs. wavelength for LUXEON C Colors at 350mA,  $T_j=85^\circ\text{C}$ .

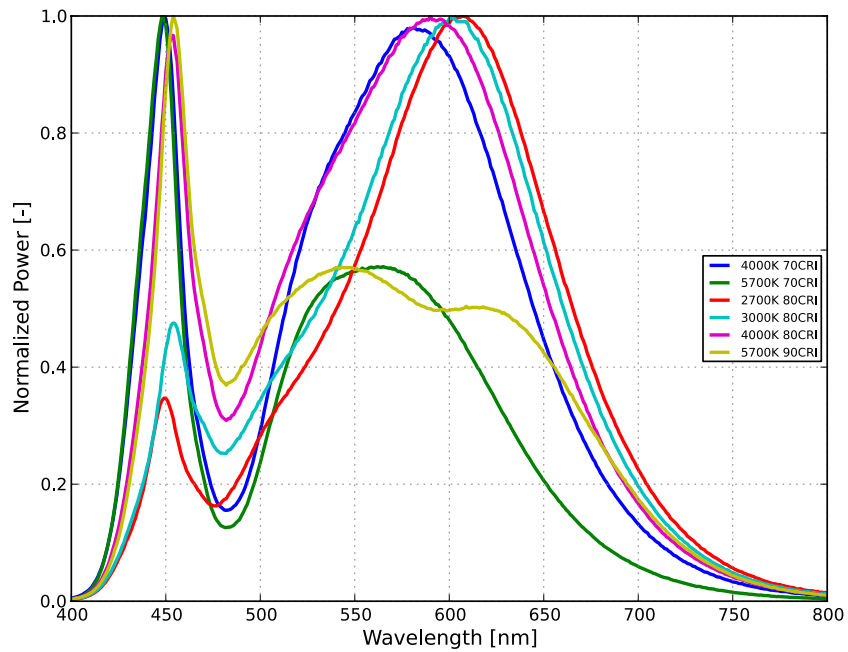

Figure 1b: Typical normalized power vs. wavelength for LUXEON C White at 350mA,  $T_j=85^\circ\text{C}$ .

# Light Output Characteristics

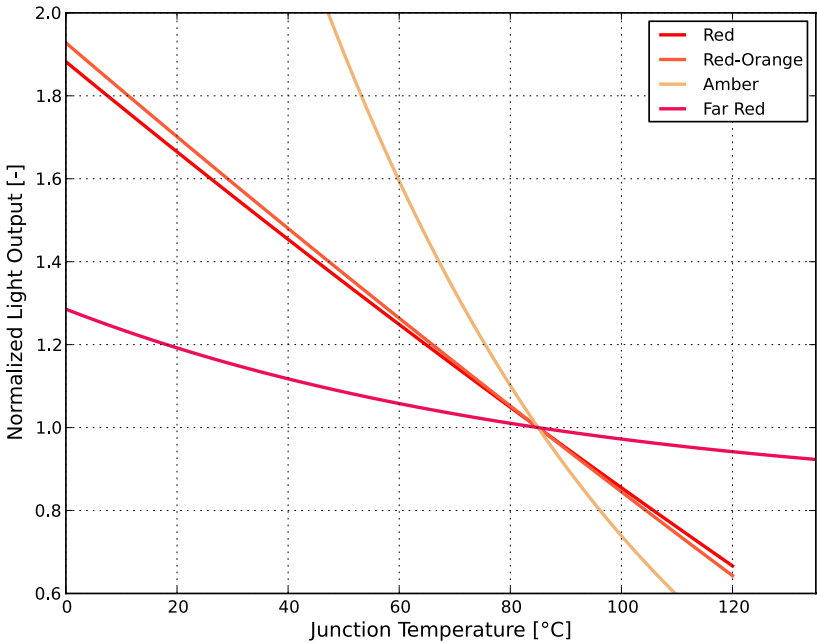

Figure 2a: Typical normalized light output vs. junction temperature for LUXEON C Far Red, Red, Red-Orange and Amber at 350mA.

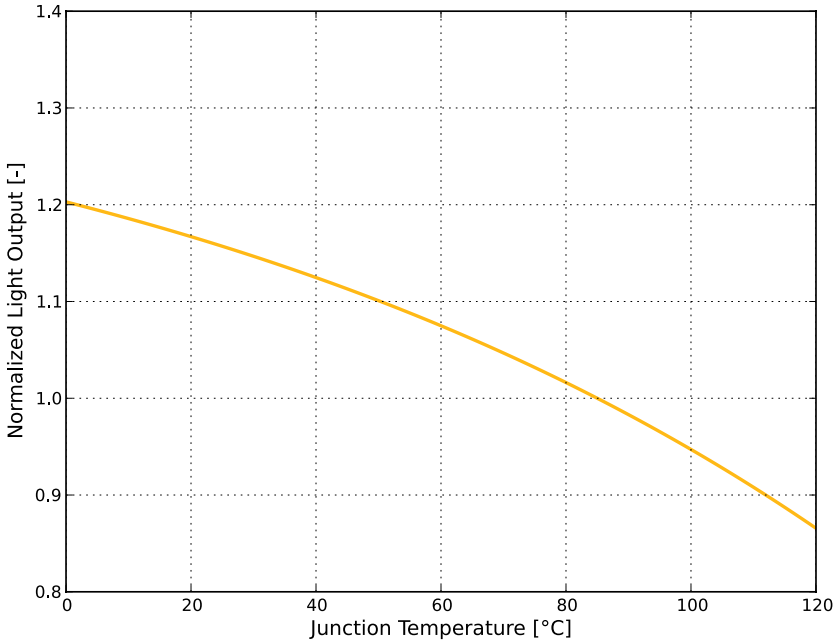

Figure 2b: Typical normalized light output vs. junction temperature for LUXEON C PC Amber at 350mA.



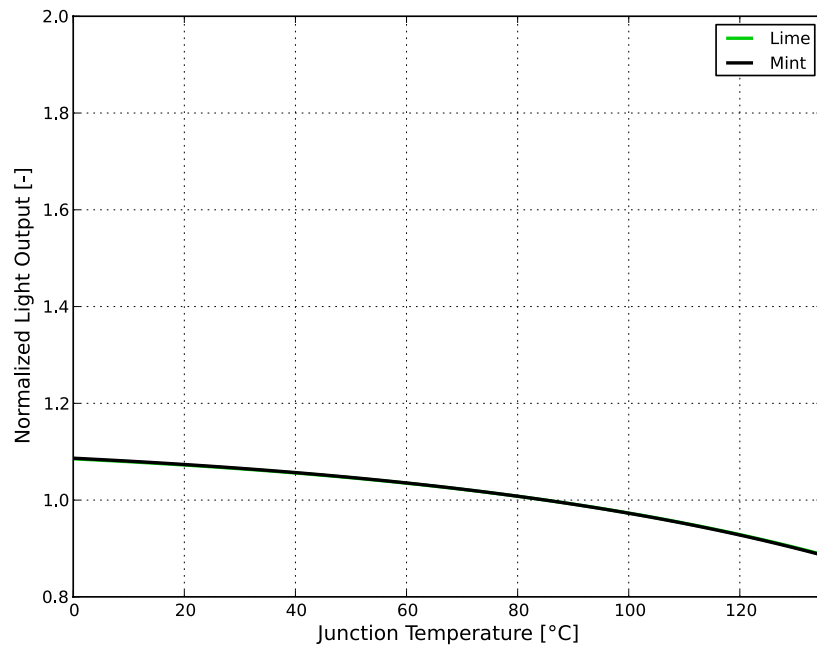

Figure 2c: Typical normalized light output vs. junction temperature for LUXEON C Mint and Lime at 350mA.

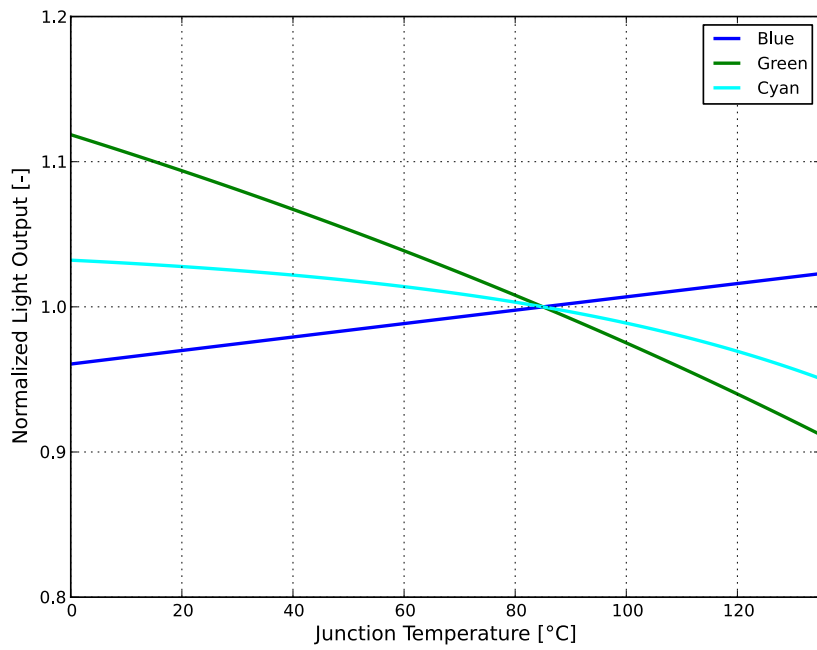

Figure 2d: Typical normalized light output vs. junction temperature for LUXEON C Green, Cyan and Blue at 350mA.

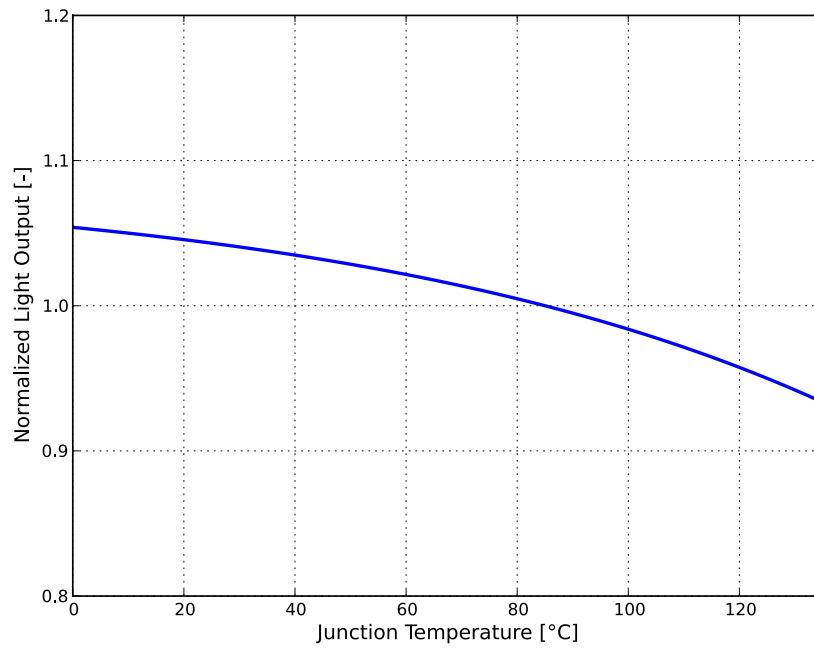

Figure 2e: Typical normalized light output vs. junction temperature for LUXEON C Royal Blue at 350mA.

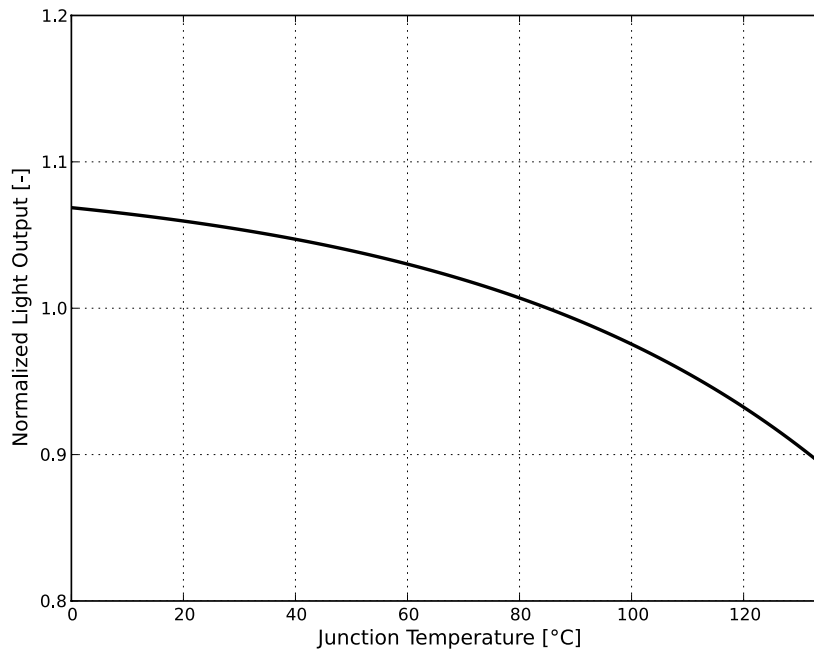

Figure 2f: Typical normalized light output vs. junction temperature for LUXEON C White at 350mA.

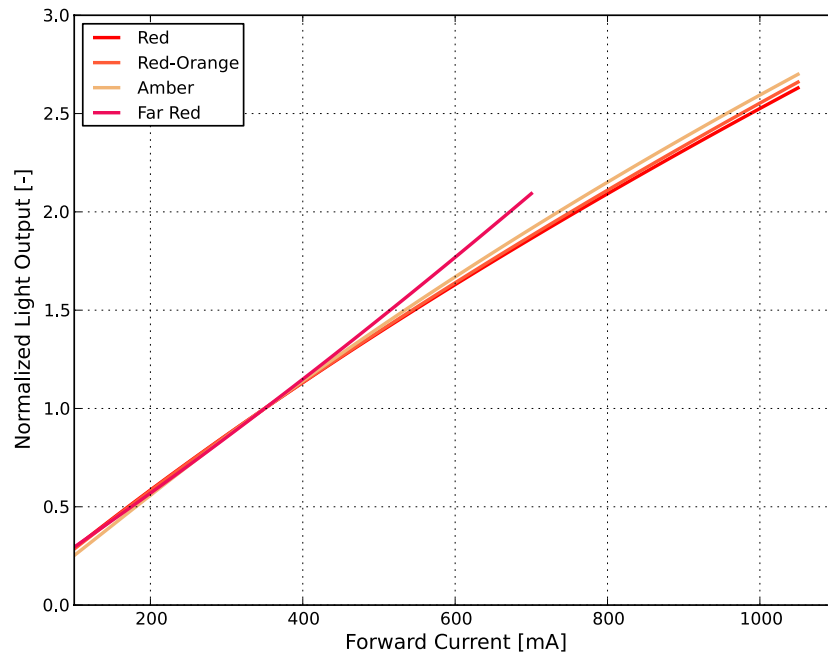

Figure 3a: Typical normalized light output vs. forward current for LUXEON C Far Red, Red, Red-Orange and Amber at  $T_j=85^\circ\text{C}$ .

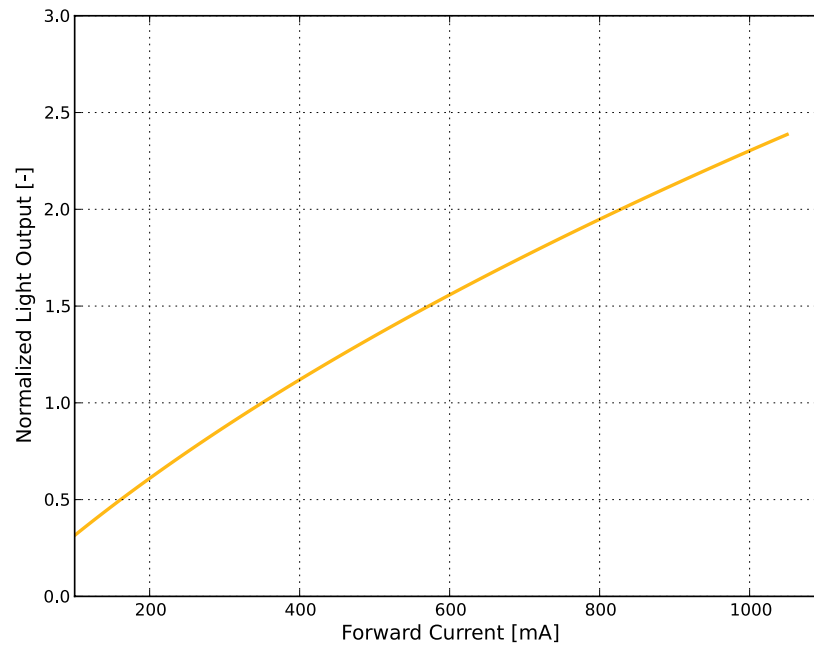

Figure 3b: Typical normalized light output vs. forward current for LUXEON C PC Amber at  $T_j=85^\circ\text{C}$ .

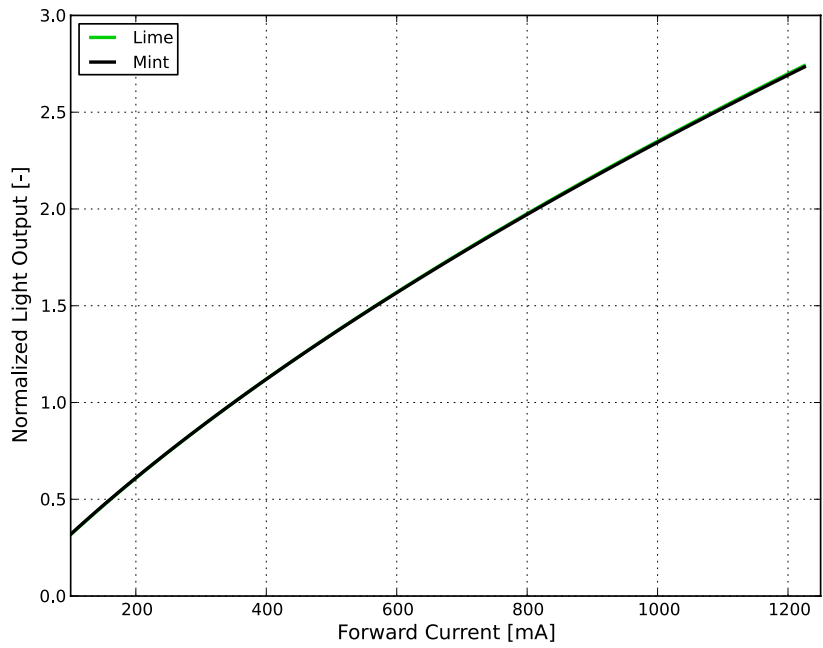

Figure 3c: Typical normalized light output vs. forward current for LUXEON C Mint and Lime at  $T_j=85^\circ\text{C}$ .

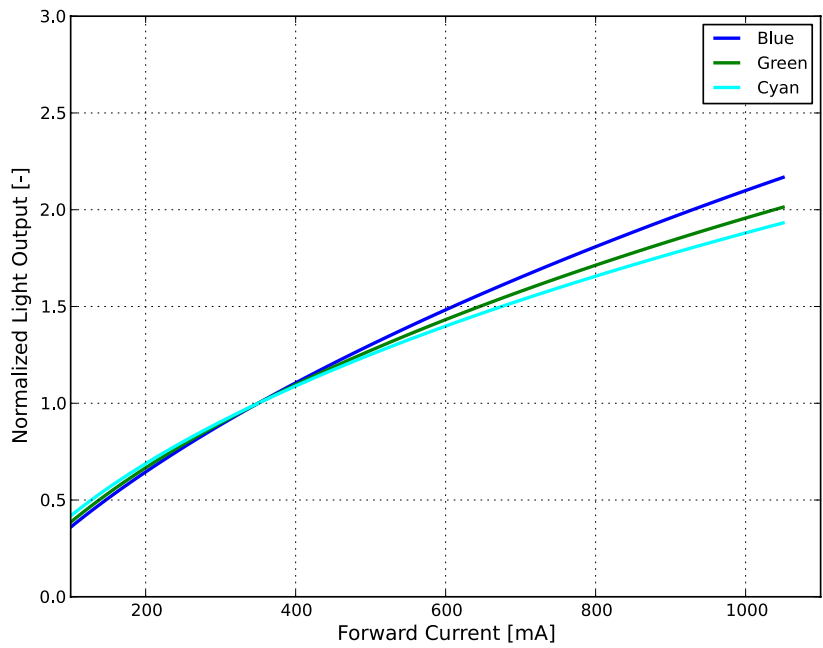

Figure 3d: Typical normalized light output vs. forward current for LUXEON C Green, Cyan and Blue at  $T_j=85^\circ\text{C}$ .

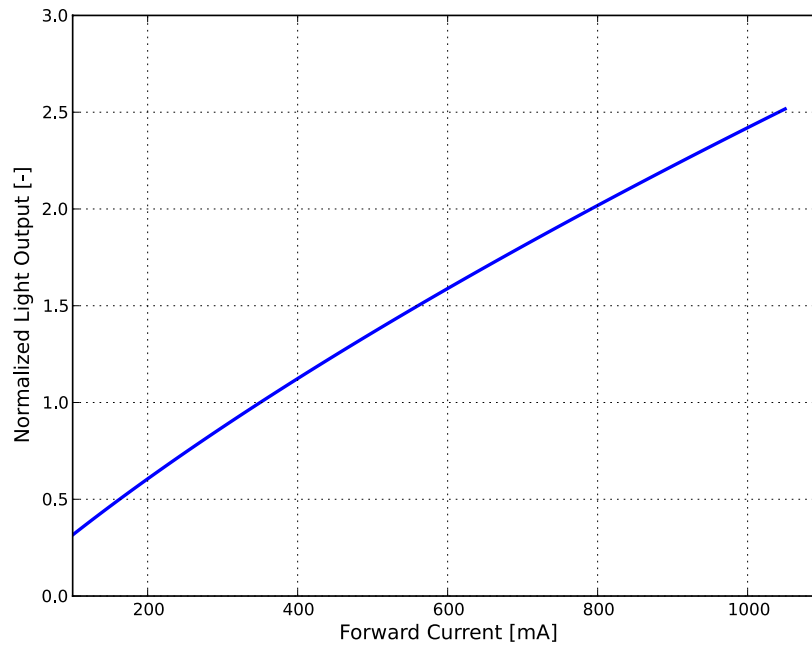

Figure 3e: Typical normalized light output vs. forward current for LUXEON C Royal Blue at  $T_j=85^\circ\text{C}$ .

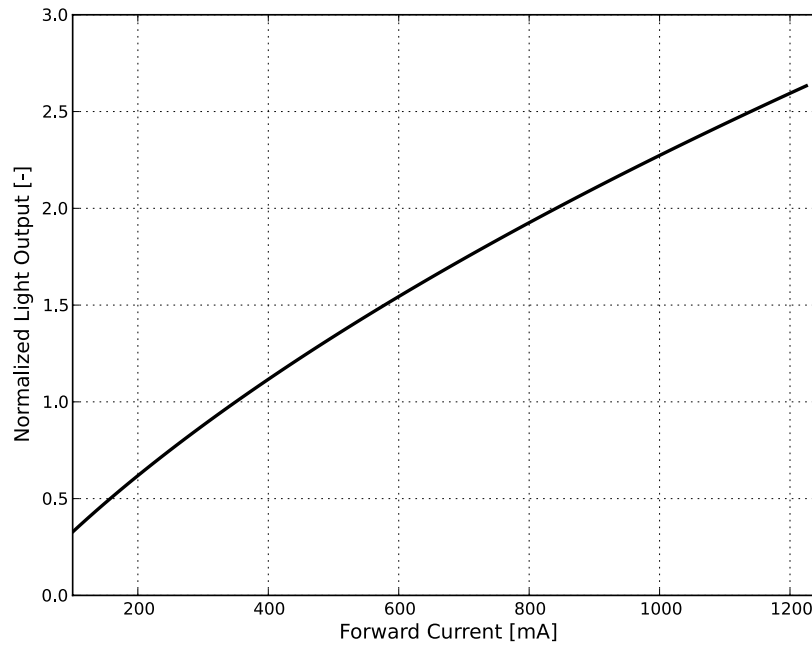

Figure 3f: Typical normalized light output vs. forward current for LUXEON C White at  $T_j=85^\circ\text{C}$ .

# Forward Current Characteristics

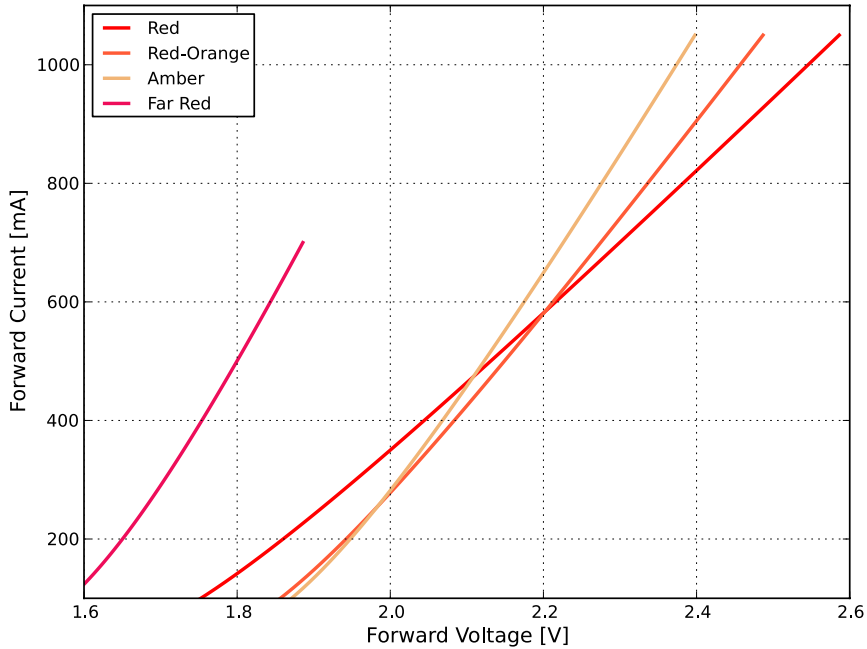

Figure 4a: Typical forward current vs. forward voltage for LUXEON C Red and Red-Orange at  $T_j=85^\circ\text{C}$ .

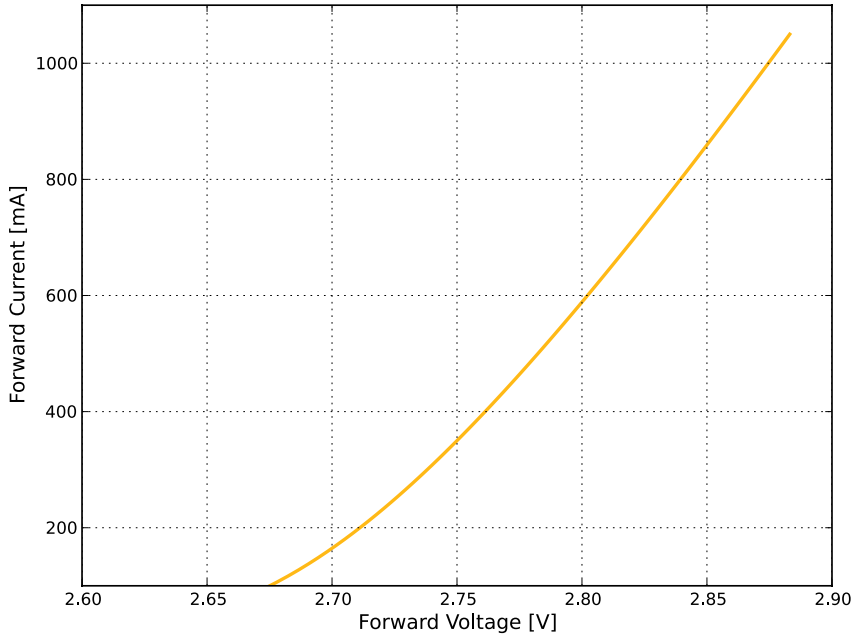

Figure 4b: Typical forward current vs. forward voltage for LUXEON C PC Amber at  $T_j=85^\circ\text{C}$ .

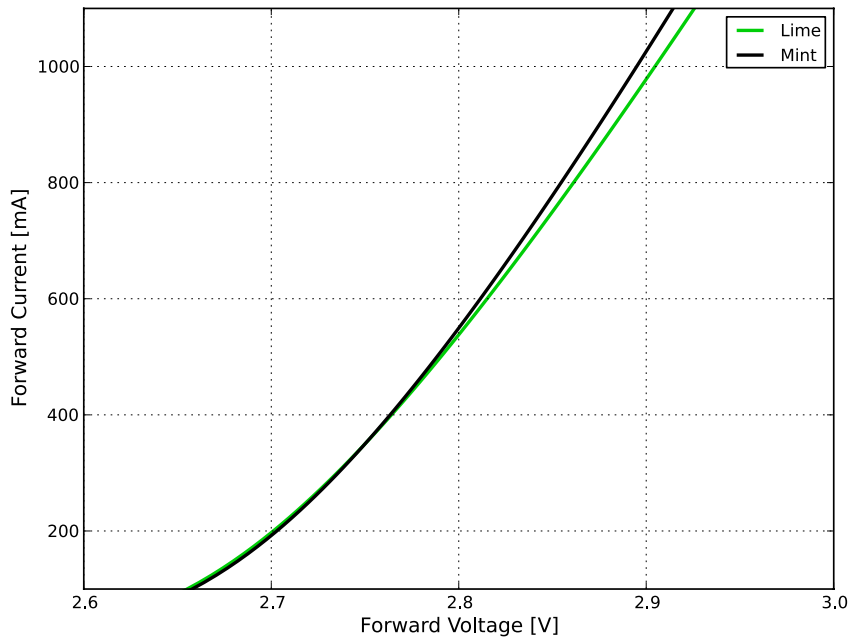

Figure 4c: Typical forward current vs. forward voltage for LUXEON C Mint and Lime at  $T_j=85^\circ\text{C}$ .

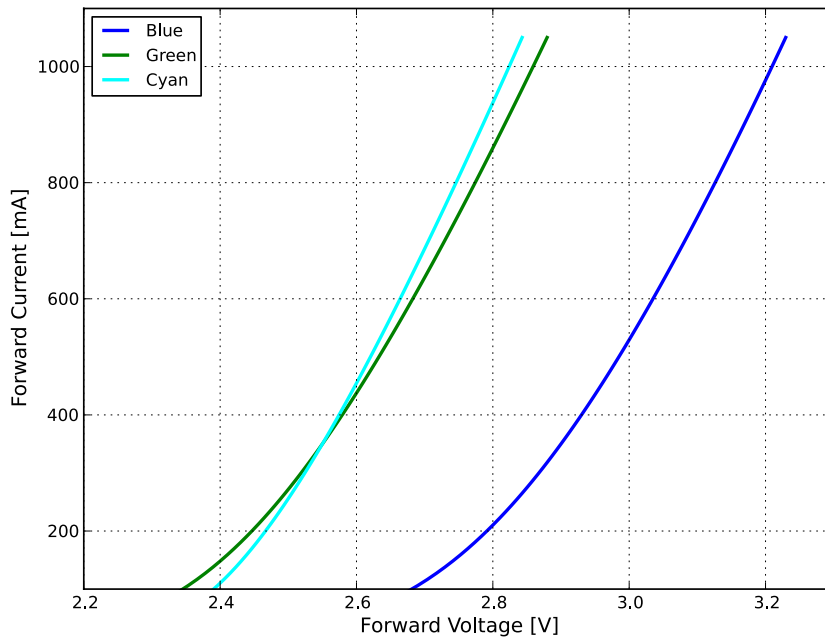

Figure 4d: Typical forward current vs. forward voltage for LUXEON C Green, Cyan and Blue at  $T_j=85^\circ\text{C}$ .

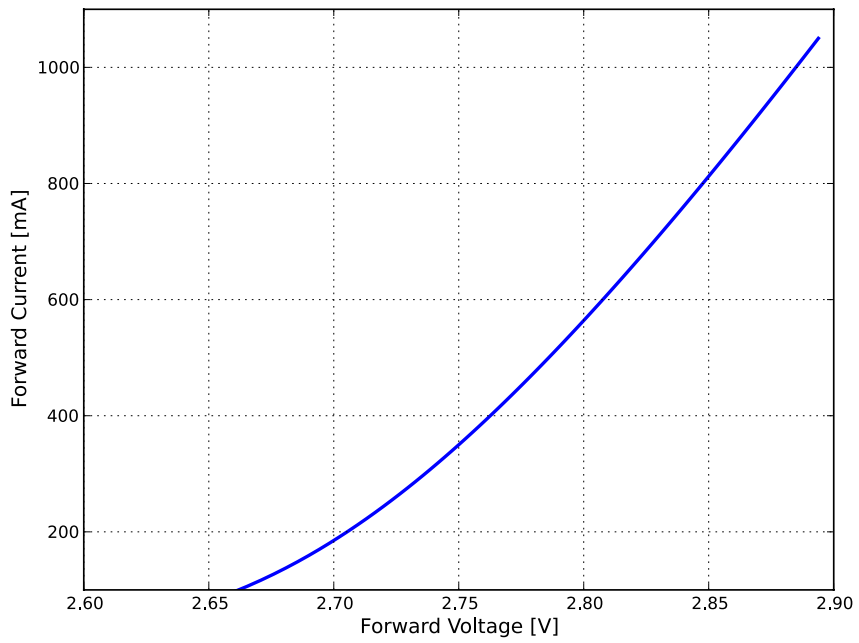

Figure 4e: Typical forward current vs. forward voltage for LUXEON C Royal Blue at  $T_j=85^\circ\text{C}$ .

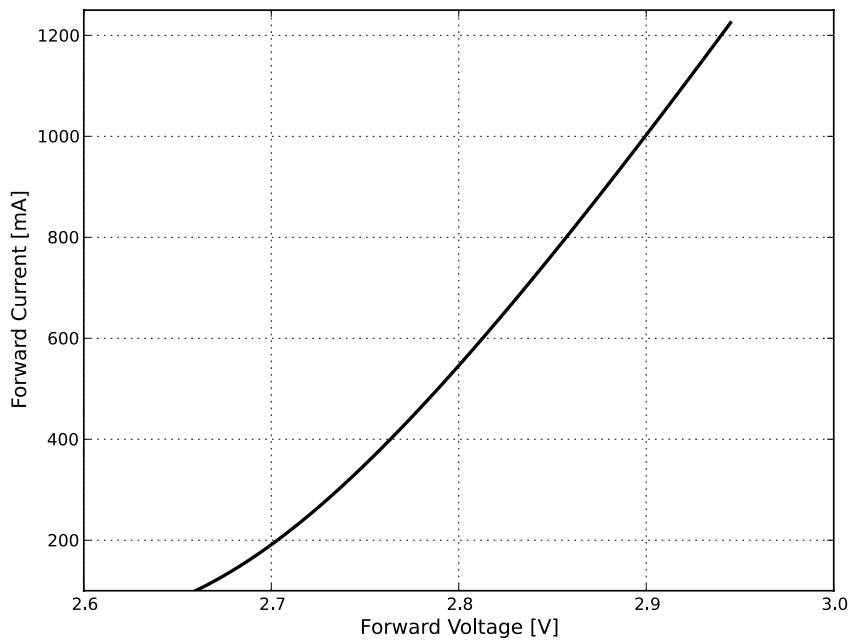

Figure 4f: Typical forward current vs. forward voltage for LUXEON C White at  $T_j=85^\circ\text{C}$ .



# Radiation Pattern Characteristics

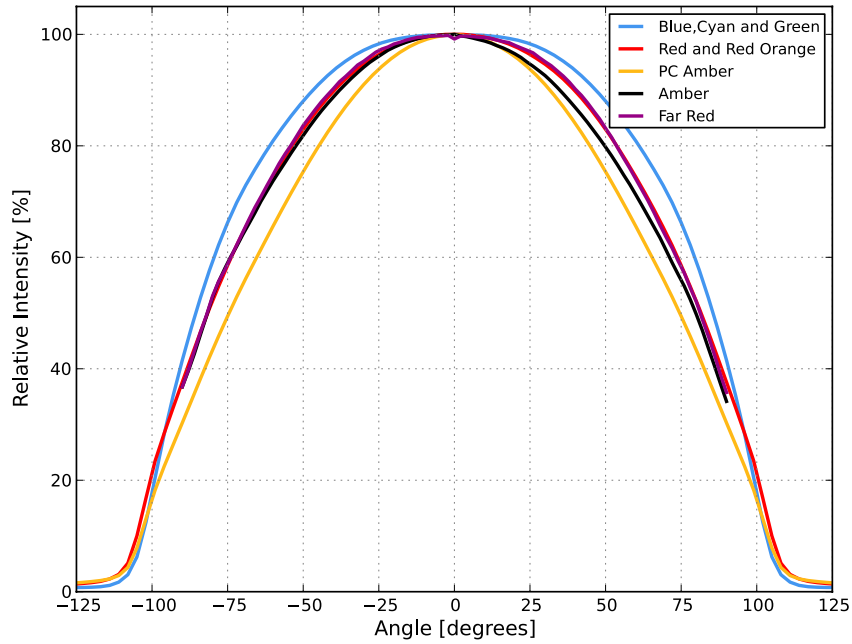

Figure 5a: Typical radiation pattern for LUXEON C Far Red, Red, Red-Orange, PC Amber, Green, Cyan and Blue at 350mA,  $T_j=85^{\circ}\text{C}$ .

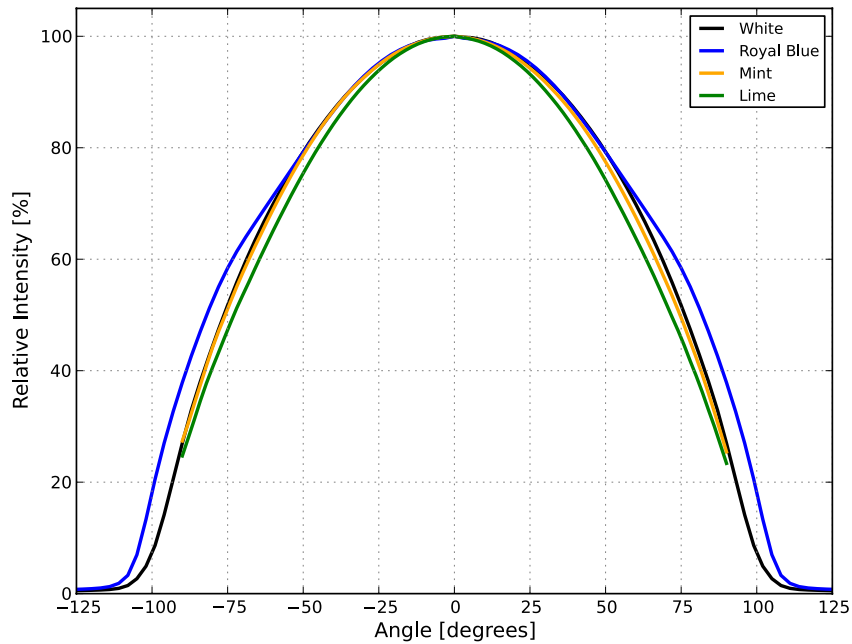

Figure 5b: Typical radiation pattern for LUXEON C Mint, Lime, Royal Blue and White at 350mA,  $T_j=85^{\circ}\text{C}$ .

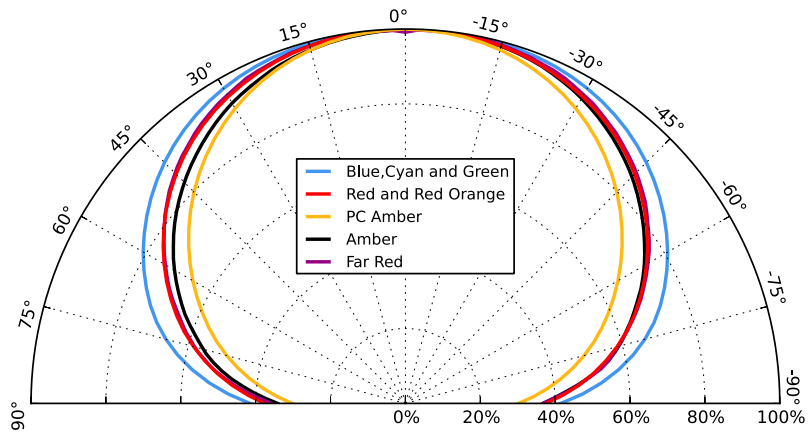

Figure 6a: Typical polar radiation pattern for LUXEON C Far Red, Red, Red-Orange, PC Amber, Green, Cyan and Blue at 350mA,  $T_j=85^\circ\text{C}$ .

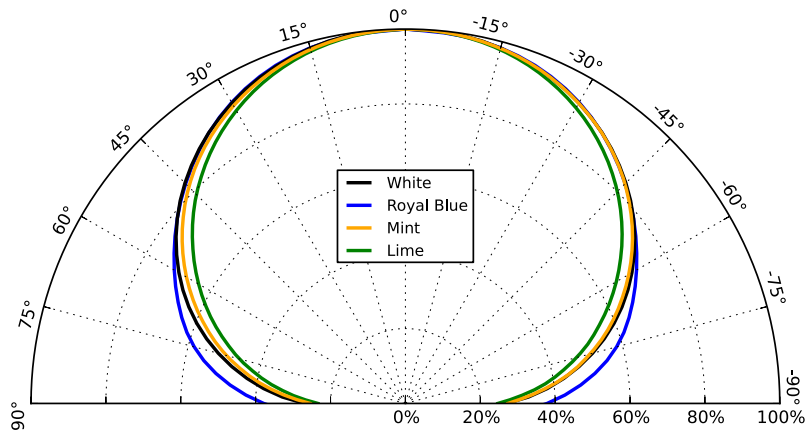

Figure 6b: Typical polar radiation pattern for LUXEON C Mint, Lime, Royal Blue and White at 350mA,  $T_j=85^\circ\text{C}$ .

# Product Bin and Labeling Definitions

## Decoding Product Bin Labeling

In the manufacturing of semiconductor products, there are variations in performance around the average values given in the technical datasheet. For this reason, Lumileds bins LED components for luminous flux, radiometric power, color point, peak wavelength, dominant wavelength and forward voltage.

LUXEON C Colors LEDs are labeled using a 4-digit alphanumeric CAT code following the format below:

### **A B C D**

Where:

- A** – designates luminous flux or radiometric power bin (example: A=20 to 25 lumens, B= 25 to 30 lumens, H=480 to 520mW, J=520 to 560mW)
- B C** – designates color, peak or dominant wavelength bin (example: Red 40=624 to 634nm, Cyan 20=496 to 500nm, Royal Blue 50=450 to 455nm)
- D** – designates forward voltage bin (example: A=1.7 to 1.9V, B=1.9 to 2.1V)

Therefore, a LUXEON C Red LED with a lumen range of 20 to 25, a dominant wavelength of 624 to 634nm and a forward voltage range of 1.7 to 1.9V has the following CAT code:

**A 4 0 A**

## Luminous Flux Bins

Table 5 lists the standard photometric luminous flux bins for LUXEON C Color Line emitters. Although several bins are outlined, product availability in a particular bin varies by production run and by product performance. Not all bins are available in all CCTs.

Table 5. Luminous flux bin definitions for LUXEON C Color Line.

BIN	LUMINOUS FLUX <sup>[1]</sup> (lm)	
	MINIMUM	MAXIMUM
A	20	25
B	25	30
C	30	35
D	35	40
E	40	45
F	45	50
G	50	55
H	55	60
J	60	65
K	65	70
L	70	75
M	75	80
N	80	90
P	90	100
Q	100	110
R	110	120
S	120	130
T	130	140
U	140	150
V	150	170
W	170	190

Notes for Table 5:

1. Lumileds maintains a tolerance of  $\pm 6.5\%$  on luminous flux measurements.

## Radiometric Power Bins

Table 6. Radiometric power bin definitions for LUXEON C Far Red and Royal Blue.

PART NUMBER	BIN	RADIOMETRIC POWER <sup>[1]</sup> (mW)	
		MINIMUM	MAXIMUM
L1C1-FRD1000000000	A	190	240
	B	240	280
	C	280	320
	D	320	360
	E	360	400
L1C1-RYL1000000000	H	480	520
	J	520	560
	K	560	600
	L	600	640

Notes for Table 6:

1. Lumileds maintains a tolerance of  $\pm 6.5\%$  on radiometric power measurements.

# Color Bin Definition

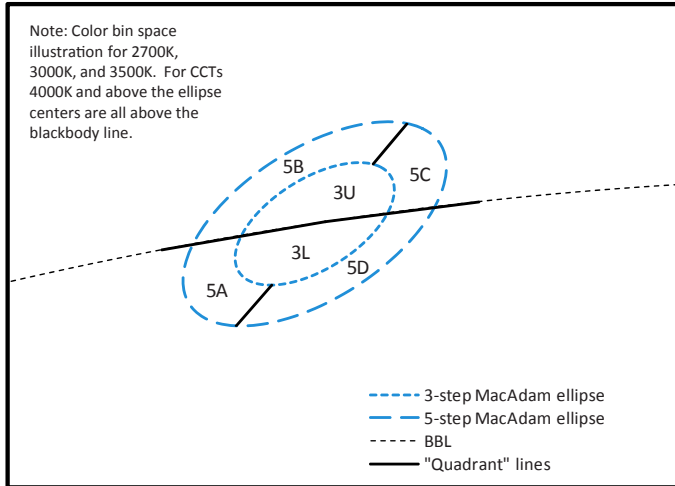

Figure 7: Color bin structure for LUXEON C Color Line.

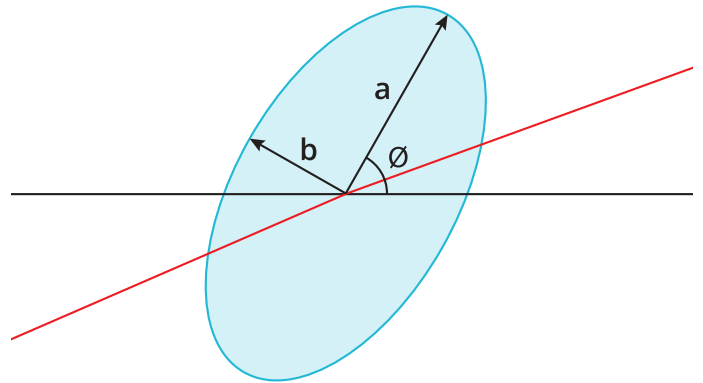

Figure 8: 3- and 5-step MacAdam ellipse illustration for Table 7.

Table 7a. 3- and 5-step MacAdam ellipse color bin definitions for LUXEON C White at 350mA,  $T_j = 85^\circ\text{C}$ .

NOMINAL CCT	COLOR SPACE	CENTER POINT (cx, cy)	MAJOR AXIS, a	MINOR AXIS, b	ELLIPSE ROTATION ANGLE, $\theta$
2700K	Single 3-step MacAdam ellipse	(0.4578, 0.4101)	0.00810	0.00420	53.7°
3000K	Single 3-step MacAdam ellipse	(0.4338, 0.4030)	0.00834	0.00408	53.2°
4000K	Single 3-step MacAdam ellipse	(0.3818, 0.3797)	0.00939	0.00402	53.7°
2700K	Single 5-step MacAdam ellipse	(0.4578, 0.4101)	0.01350	0.00700	53.7°
3000K	Single 5-step MacAdam ellipse	(0.4338, 0.4030)	0.01390	0.00680	53.2°
4000K	Single 5-step MacAdam ellipse	(0.3818, 0.3797)	0.01565	0.00670	53.7°
5700K	Single 5-step MacAdam ellipse	(0.3287, 0.3417)	0.01243	0.00533	59.1°

**Notes for Table 7a:**

1. Lumileds maintains a tolerance of  $\pm 0.005$  on x and y coordinates in the CIE 1931 color space.

Table 7b. MacAdam ellipse color bin definitions for LUXEON C Color Line.

BIN	SDCM
30	3-step MacAdam ellipse (90CRI)
3U	3-step MacAdam ellipse (80CRI)
3L	3-step MacAdam ellipse (80CRI)
50	5-step MacAdam ellipse (70 and 90CRI)
5A	5-step MacAdam ellipse (80, 90CRI)
5B	5-step MacAdam ellipse (80, 90CRI)
5C	5-step MacAdam ellipse (80, 90CRI)
5D	5-step MacAdam ellipse (80, 90CRI)

## Dominant Wavelength Bins

Table 8. Dominant wavelength bins for LUXEON C Red, Red-Orange, Amber, Green, Cyan and Blue at 350mA, T<sub>j</sub>=85°C.

PART NUMBER	BIN	DOMINANT WAVELENGTH <sup>[1]</sup> (nm)	
		MINIMUM	MAXIMUM
L1C1-RED1000000000	40	624.0	634.0
L1C1-RNG1000000000	20	614.0	624.0
L1C1-AMB1000000000	10	585.0	590.0
	20	590.0	594.5
	30	594.5	600.0
L1C1-GRN1000000000	10	520.0	525.0
	20	525.0	530.0
	30	530.0	535.0
	40	535.0	540.0
L1C1-CYN1000000000	10	490.0	496.0
	20	496.0	500.0
	30	500.0	505.0
	40	505.0	510.0
L1C1-BLU1000000000	10	460.0	465.0
	20	465.0	470.0
	30	470.0	475.0
	40	475.0	480.0
	50	480.0	485.0

**Notes for Table 8:**

1. Lumileds maintains a tolerance of ±0.5nm on dominant wavelength measurements.

## Peak Wavelength Bins

Table 9. Peak wavelength bins for LUXEON C Far Red and Royal Blue.

PART NUMBER	BIN	PEAK WAVELENGTH <sup>[1]</sup> (nm)	
		MINIMUM	MAXIMUM
L1C1-FRD1000000000	10	720	730
	20	730	740
	30	740	750
L1C1-RYL1000000000	30	440	445
	40	445	450
	50	450	455
	60	455	460

**Notes for Table 9:**

1. Lumileds maintains a tolerance of ±2.0nm on peak wavelength measurements.

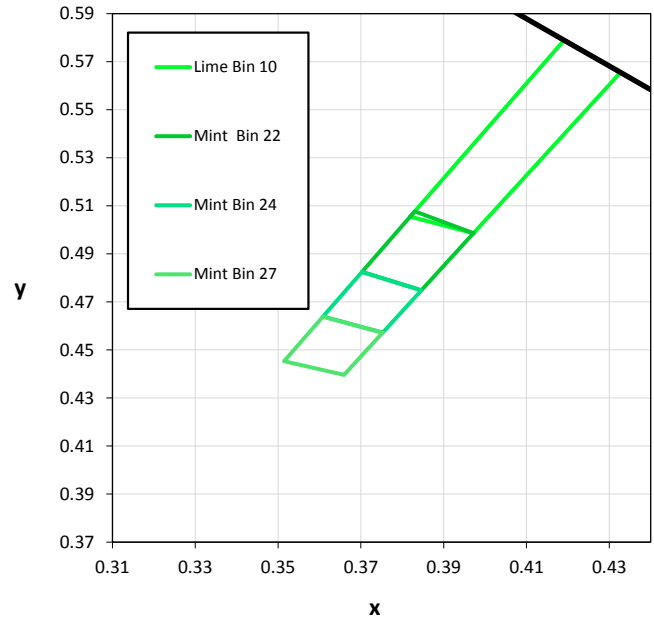
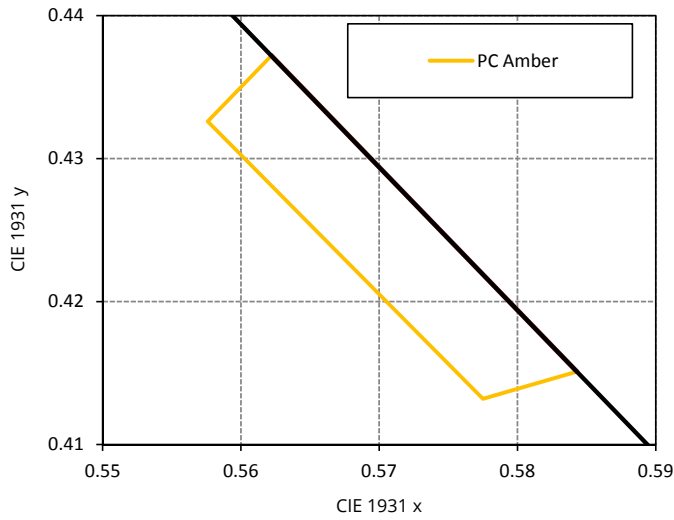

Figure 9: Color bin structure for LUXEON C PC Amber for Table 10.

Figure 10: Color bin structure for Mint and Lime for Table 10.

Table 10. Color bin definitions for LUXEON C PC Amber, Mint and Lime.

PART NUMBER	BIN	x	y
L1C1-PCA1000000000	20	0.5622	0.4372
		0.5576	0.4326
		0.5775	0.4132
		0.5843	0.4151
L1C1-MNT1000000000	22	0.3972	0.4986
		0.3830	0.5077
		0.3703	0.4825
		0.3846	0.4749
	24	0.3846	0.4749
		0.3703	0.4825
		0.3608	0.4639
	27	0.3752	0.4572
		0.3752	0.4572
		0.3608	0.4639
L1C1-LME1000000000	10	0.3515	0.4453
		0.3659	0.4396
		0.3819	0.5055
		0.4191	0.5790
		0.4327	0.5655
		0.3972	0.4986

Notes for Table 10:

1. Lumileds maintains a tolerance of  $\pm 0.005$  on x and y color coordinates measurements.

# Forward Voltage Bins

Table 11. Forward voltage bin definitions for LUXEON C Color Line.

BIN	FORWARD VOLTAGE <sup>(1)</sup> (V)	
	MINIMUM	MAXIMUM
A	1.70	1.90
B	1.90	2.10
C	2.10	2.30
D	2.30	2.50
E	2.50	2.70
F	2.70	2.90
G	2.90	3.10
H	3.10	3.30
J	3.30	3.50

**Notes for Table 11:**

1. Lumileds maintains a tolerance of  $\pm 0.06V$  on forward voltage measurements.



# Mechanical Dimensions

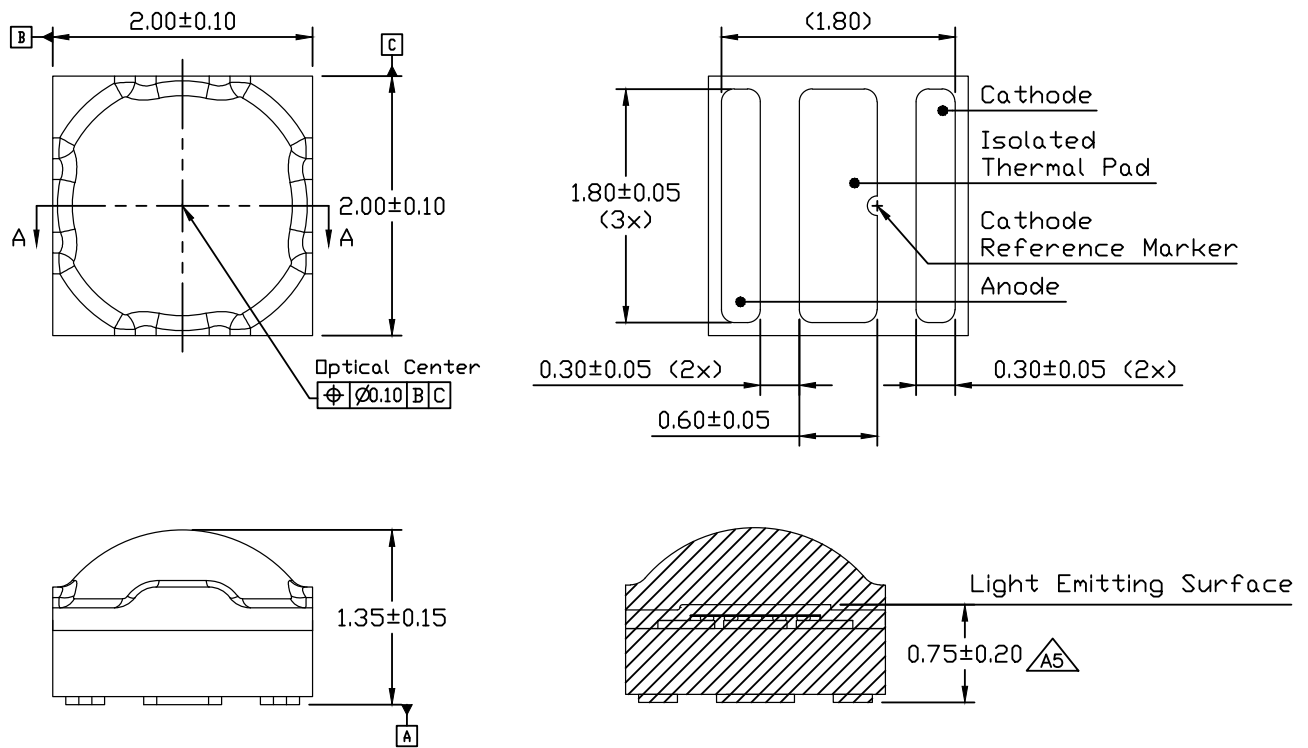

Figure 11: Mechanical dimensions for LUXEON C Color Line.

Notes for Figure 11:

1. Drawings are not to scale.
2. All dimensions are in millimeters.

# Reflow Soldering Guidelines

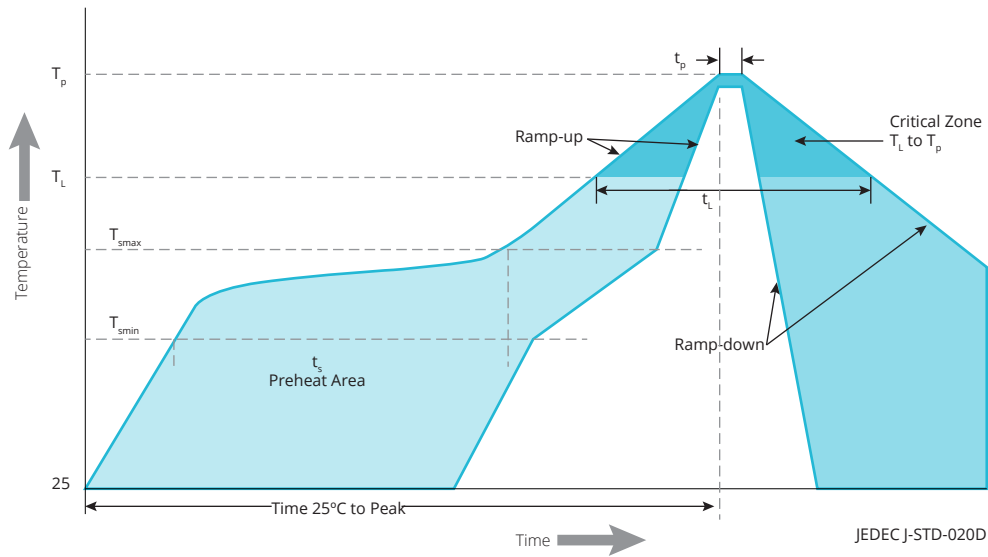

Figure 12: Visualization of the acceptable reflow temperature profile as specified in Table 12.

Table 12. Reflow profile characteristics for LUXEON C Color Line.

PROFILE FEATURE	LEAD-FREE ASSEMBLY
Preheat Minimum Temperature ( $T_{smin}$ )	150°C
Preheat Maximum Temperature ( $T_{smax}$ )	200°C
Preheat Time ( $t_{smin}$ to $t_{smax}$ )	60 to 120 seconds
Ramp-Up Rate ( $T_L$ to $T_p$ )	3°C / second maximum
Liquidus Temperature ( $T_L$ )	217°C
Time Maintained Above Temperature $T_L$ ( $t_L$ )	60 to 150 seconds
Peak / Classification Temperature ( $T_p$ )	260°C
Time Within 5°C of Actual Temperature ( $t_p$ )	20 to 40 seconds
Ramp-Down Rate ( $T_p$ to $T_L$ )	6°C / second maximum
Time 25°C to Peak Temperature	8 minutes maximum

## JEDEC Moisture Sensitivity

Table 13. Moisture sensitivity levels for LUXEON C Color Line.

LEVEL	FLOOR LIFE		SOAK REQUIREMENTS STANDARD	
	TIME	CONDITIONS	TIME	CONDITIONS
1	Unlimited	≤30°C / 85% RH	168 Hours +5 / -0	85°C / 85% RH

# Solder Pad Design

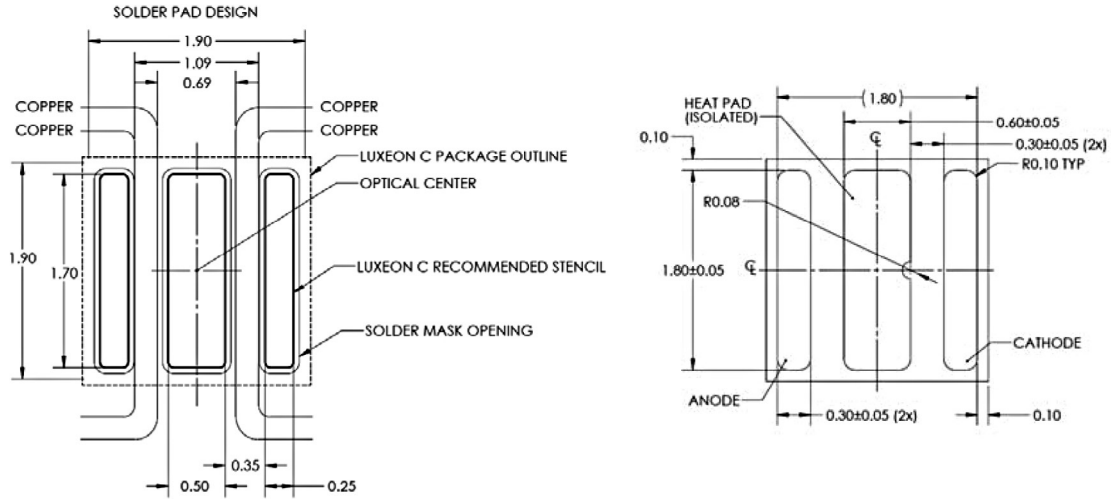

Figure 13: Recommended PCB solder pad layout for LUXEON C Color Line.

Notes for Figure 13:

1. Drawings are not to scale.
2. All dimensions are in millimeters.
3. The drawing above shows the recommended solder pad layout on Printed Circuit Board (PCB).

# Packaging Information

## Pocket Tape Dimensions

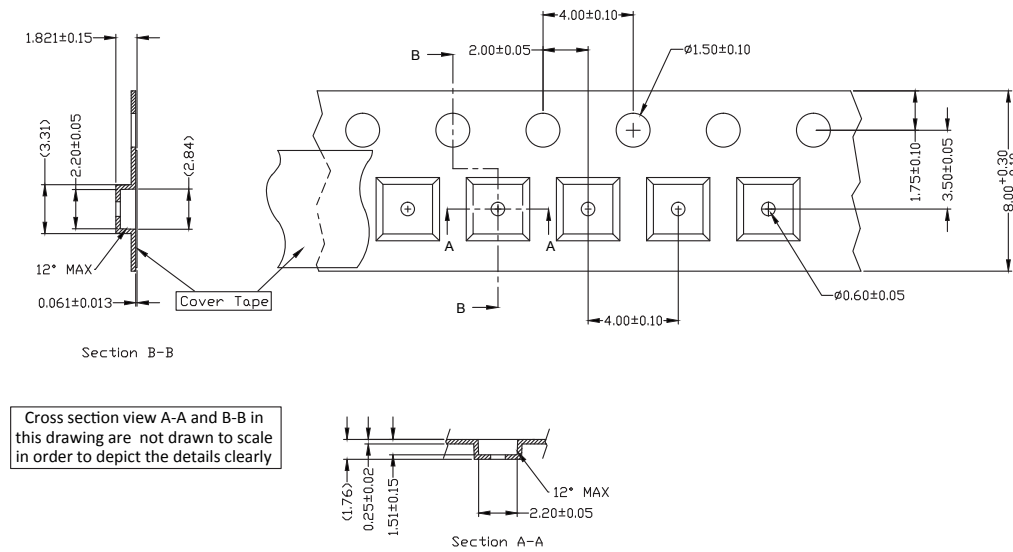

Cross section view A-A and B-B in this drawing are not drawn to scale in order to depict the details clearly

Figure 14: Pocket Tape dimensions for LUXEON C Color Line.

Notes for Figure 14:

1. Drawings are not to scale.
2. All dimensions are in millimeters.

# Reel Dimensions

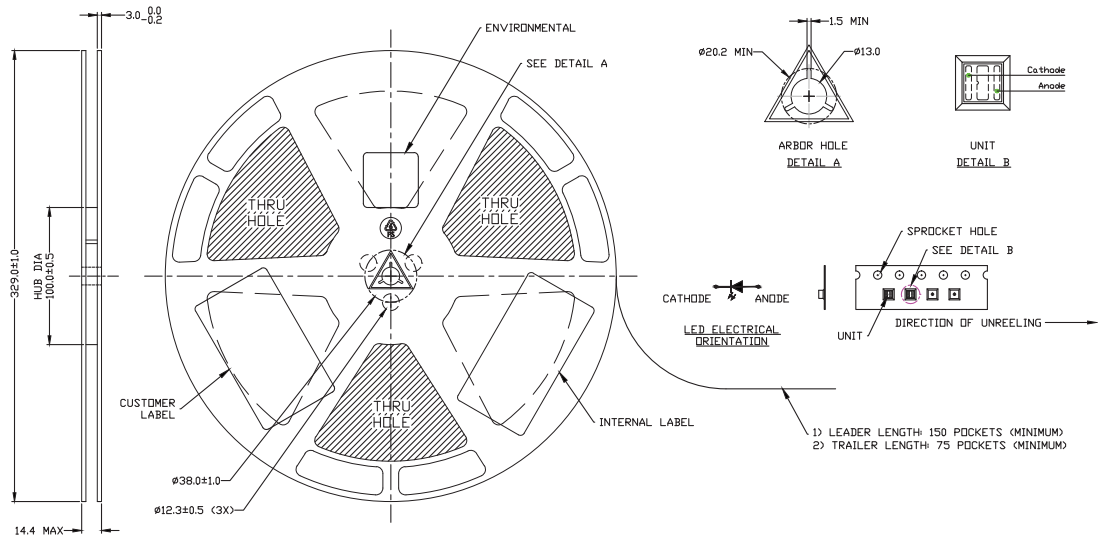

Figure 15: Reel dimensions for LUXEON C Color Line.

**Notes for Figure 15:**

1. Drawings are not to scale.
2. All dimensions are in millimeters.
3. Maximum 1000 pieces per reel.

## About Lumileds

Lumileds is the global leader in light engine technology. The company develops, manufactures and distributes groundbreaking LEDs and automotive lighting products that shatter the status quo and help customers gain and maintain a competitive edge. With a rich history of industry “firsts,” Lumileds is uniquely positioned to deliver lighting advancements well into the future by maintaining an unwavering focus on quality, innovation and reliability.

To learn more about our portfolio of light engines, visit [lumileds.com](http://lumileds.com).



---

©2016 Lumileds Holding B.V. All rights reserved.  
LUXEON is a registered trademark of the Lumileds Holding B.V.  
in the United States and other countries.  
[lumileds.com](http://lumileds.com)

Neither Lumileds Holding B.V. nor its affiliates shall be liable for any kind of loss of data or any other damages, direct, indirect or consequential, resulting from the use of the provided information and data. Although Lumileds Holding B.V. and/or its affiliates have attempted to provide the most accurate information and data, the materials and services information and data are provided “as is,” and neither Lumileds Holding B.V. nor its affiliates warrants or guarantees the contents and correctness of the provided information and data. Lumileds Holding B.V. and its affiliates reserve the right to make changes without notice. You as user agree to this disclaimer and user agreement with the download or use of the provided materials, information and data.