



FC22

Compression Load Cell

SPECIFICATIONS

- **10 – 100 lbf Ranges**
- **High Level or mV Outputs**
- **Interchangeable**
- **Compact Easy to Fixture Design**
- **CE Compliance**

The FC22 is a medium compression force sensor that creates new markets previously unrealizable due to cost and performance constraints. The FC22 offers normalized zero and span for interchangeability and is thermally compensated for changes in zero and span with respect to temperature.

The FC22 incorporates MEAS' proprietary Microfused technology which employs micromachined silicon piezoresistive strain gages fused with high temperature glass to a high performance stainless steel substrate. Microfused technology eliminates age-sensitive organic epoxies used in traditional load cell designs providing excellent long term span and zero stability. The FC22 measures direct force and is therefore not subject to lead-die fatigue failure common with competitive designs which use a pressure capsule embedded within a silicone gel-filled cavity. Operating at very low strains, Microfused technology provides an essentially unlimited cycle life expectancy, superior resolution, and high over-range capabilities.

Cost-optimization of the FC22 brings your OEM product to life whether you need thousands or millions of load cells annually. Although the standard model is ideal for a wide range of applications, our dedicated design team at our Load Cell Engineering Center is ready to provide you with custom designs for your OEM applications.

Please refer to the FS20 for lower force applications or the FC23 for higher force applications.

FEATURES

- Small Size
- Low Noise
- Robust: High Over-Range Capability
- High Reliability
- Low Deflection
- Essentially Unlimited Cycle Life Expectancy
- Low Off Center Errors
- Fast Response Time
- 10 to 100 lbf Ranges
- Reverse Polarity Protected

APPLICATIONS

- Medical Infusion Pumps
- Robotics End-Effectors
- Variable Force Control
- Load and Compression Sensing
- Exercise Machines
- Pumps
- Contact Sensing
- Weighing
- Household Appliances

STANDARD RANGES

Range	lbf
0 to 0010	•
0 to 0025	•
0 to 0050	•
0 to 0100	•

PERFORMANCE SPECIFICATIONS

Supply Voltage: 5.0V, Ambient Temperature: 25°C (unless otherwise specified)

PARAMETERS	MIN	TYP	MAX	UNITS	NOTES
Span (Unamplified, FC2201)	24	30	36	mV/V	1
Span (Unamplified, FC2211)	19	20	21	mV/V	1
Span (Amplified)	3.8	4.00	4.2	V	1
Zero Force Output (Unamplified, FC2201)	-1	0	1	mV/V	1
Zero Force Output (Unamplified, FC2211)	-0.5	0	0.5	mV/V	1
Zero Force Output (Amplified)	0.45	0.5	0.55	V	1
Accuracy (non-linearity, hysteresis, and repeatability)		±1		%Span	2
Output Resistance (Unamplified)		2.2		kΩ	
Input Resistance (Unamplified)		3		kΩ	
Temperature Error – Zero	-1.25		1.25	%Span	3
Temperature Error – Span	-1.25		1.25	%Span	3
Long Term Stability (1 year)		±1		%Span	
Maximum Overload	2.5X			Rated	
Compensated Temperature	0		50	°C	
Operating Temperature	-40		+85	°C	
Storage Temperature	-40		+85	°C	
Excitation Voltage (Unamplified)			5	V _{DC}	
Excitation Voltage (Amplified)	4.75	5	5.25	V _{DC}	
Isolation Resistance (250V _{dc})	50			MΩ	
Deflection at Rated Load			0.05	mm	
Humidity	0		90	%RH	
Weight		18.41		grams	

For custom configurations, consult factory

Notes

1. Ratiometric to supply.
2. Best fit straight line.
3. Maximum temperature error over compensated range with respect to 25°C.

CE Compliance

IEC61000-4-2 [4 kV/ 4kV (Air/Contact)]

IEC61000-4-3 (3 V/m)

IEC55022 Class A

DIMENSIONS

FC2201:
FC2211:
FC2231:

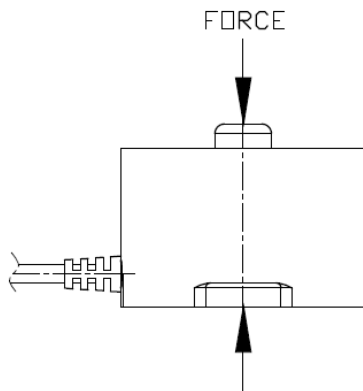
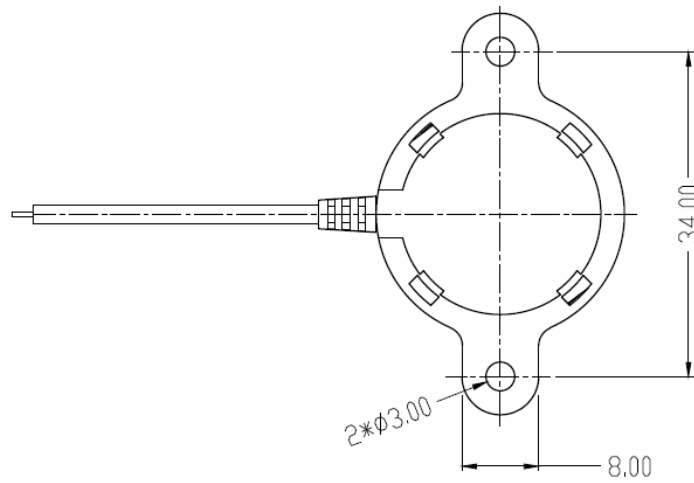
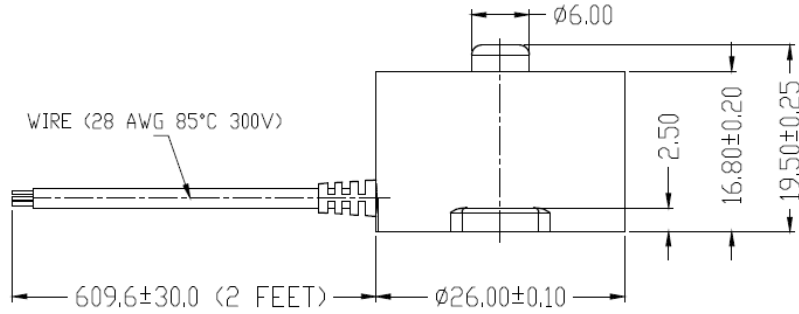

WIRE NOTE:

P/N	WIRE CONNECTIONS
FC2201 FC2211	4 CORE WIRE (28 AWG 85°C 300V)
	1: YELLOW: +OUTPUT
	2: WHITE: -OUTPUT
	3: RED: +INPUT
FC2231	4: BLACK: -INPUT
	3 CORE WIRE (28 AWG 85°C 300V)
	1: YELLOW: +OUTPUT
	2: RED: +INPUT
	3: BLACK: COMMON

CONNECTIONS

FC2201:
FC2211:
MILLIVOLT OUTPUT VERSION

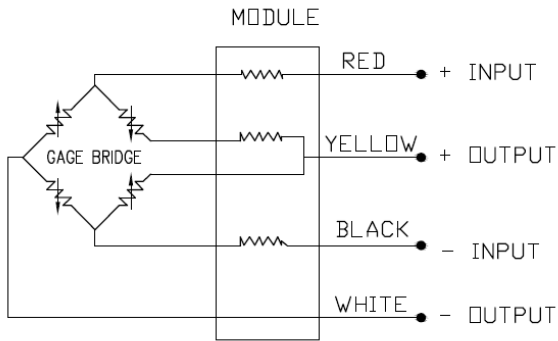

FC2231:
AMPLIFIED OUTPUT VERSION

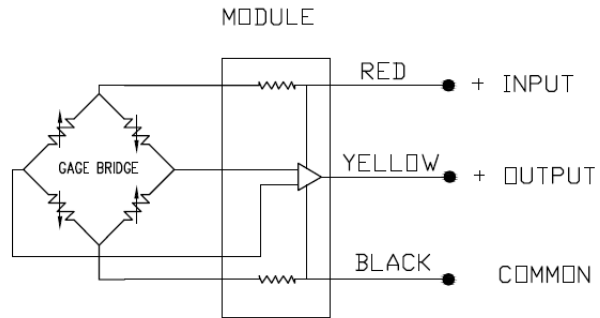

ORDERING INFORMATION

FC22 - 3 1 0000 0100 - L

Output	
Code	Output
0	0 – 150 mV
1	0 – 100 mV
3	0.5 – 4.5 V

Connection	
1	2 feet Cable

Vent	
L	lbf

Multiplier	
-	None

Force Range	
0010	
0025	
0050	
0100	

NORTH AMERICA

Measurement Specialties, Inc.,
a TE Connectivity Company
Tel: 1-800-522-6752
Email : customercare.lcsb@te.com

EUROPE

MEAS France SAS,
a TE Connectivity company
Tel: +31 73 624 6999
Email : customercare.lcsb@te.com

ASIA

Measurement Specialties (China), Ltd.,
a TE Connectivity Company
Tel: +86 400-820-6015
Email: customercare.shzn@te.com

TE.com/sensorsolutions

Measurement Specialties, Inc., a TE Connectivity company.

Measurement Specialties, TE Connectivity, TE Connectivity (logo) and EVERY CONNECTION COUNTS are trademarks. All other logos, products and/or company names referred to herein might be trademarks of their respective owners.

The information given herein, including drawings, illustrations and schematics which are intended for illustration purposes only, is believed to be reliable. However, TE Connectivity makes no warranties as to its accuracy or completeness and disclaims any liability in connection with its use. TE Connectivity's obligations shall only be as set forth in TE Connectivity's Standard Terms and Conditions of Sale for this product and in no case will TE Connectivity be liable for any incidental, indirect or consequential damages arising out of the sale, resale, use or misuse of the product. Users of TE Connectivity products should make their own evaluation to determine the suitability of each such product for the specific application.

© 2015 TE Connectivity Ltd. family of companies All Rights Reserved.

Mouser Electronics

Authorized Distributor

Click to View Pricing, Inventory, Delivery & Lifecycle Information:

[TE Connectivity:](#)

[FC2211-0000-0010-L](#)