

LOCKS Push **button**

INSTALLATION INSTRUCTIONS

Models

2250 / 2255

Codelocks Ltd

Tel : 01635 268 029

Fax : 01635 268 031

PUSHBUTTON 2250/2255:

CONTENTS

1

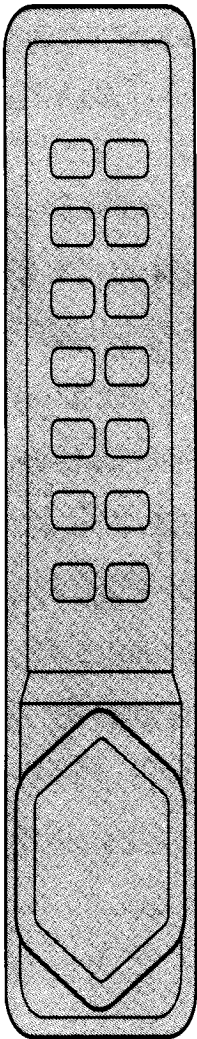

2

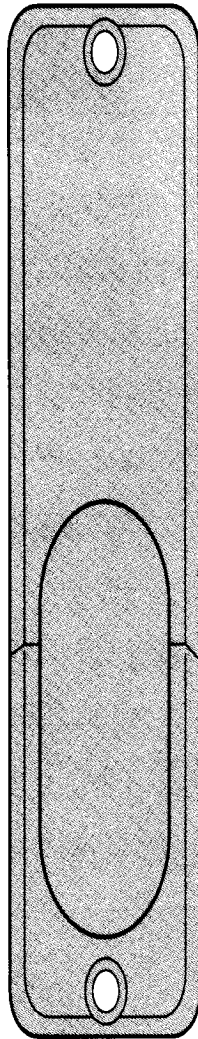

3



1. Lock case.
2. Back plate.
(2255 has a 'hold-open' snib).
3. Neoprene seals. x 2.
4. Spindles. (Only one is used).
5. Latch (60mm standard).
6. Strike plate.
7. Wood screws. x 4.
Use with latch & strike plate.
8. Latch support post.
9. Tweezers. (For changing the code).
10. Fixing bolts. 3 supplied (1 spare).
11. Code tumblers. Spare x 2.
12. Code card.



4

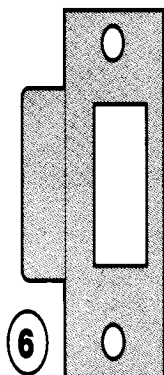
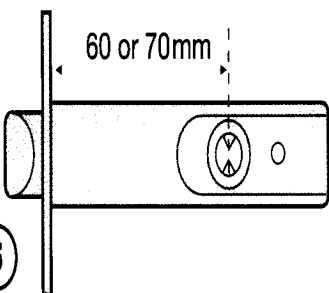

7

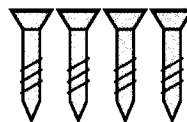

10

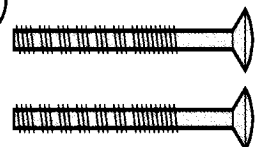

5

8

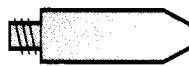

11



9



12

C3567X

SPECIAL NOTES

- The 2255 'Hold-open' model is equipped with a snib on the backplate. This enables the latchbolt to be held open when required.
- Before commencing installation check that all parts are working correctly: Press the code according to the code card and then the knob should turn and return easily under spring pressure. If you intend to change the code then, if it is convenient, you should do it before installing the lock - see the code change instructions in the separate leaflet.
- Make sure that the lever handle of the backplate moves freely. If the lock is a 2255 then check that the snib will engage and hold the handle in the 'latch-open' position.
- Check that the latch bolt moves freely by pressing at the end and also by turning the flat spindle in the latch cam.

1 CHECK THE HAND OF YOUR DOOR

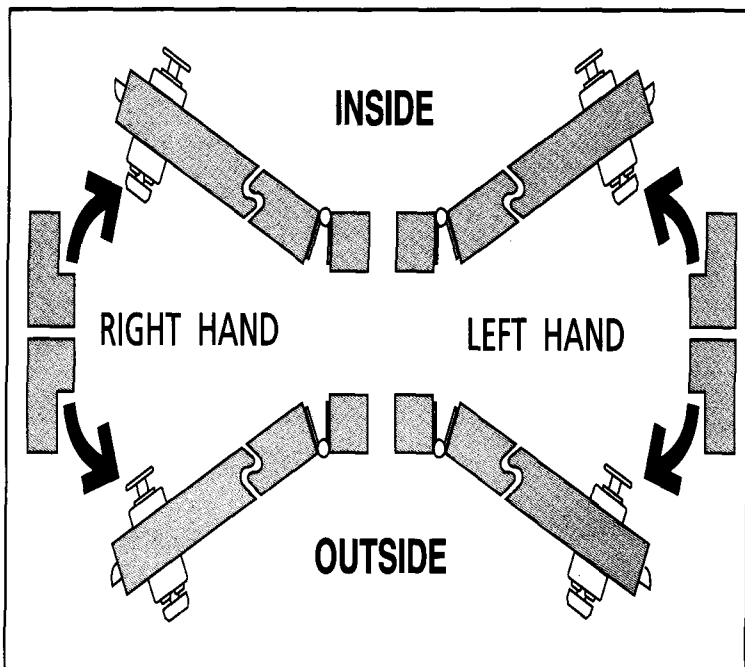

Your door is right-handed if, viewed from the outside, the hinges are on the right.

2 APPLY THE TEMPLATE

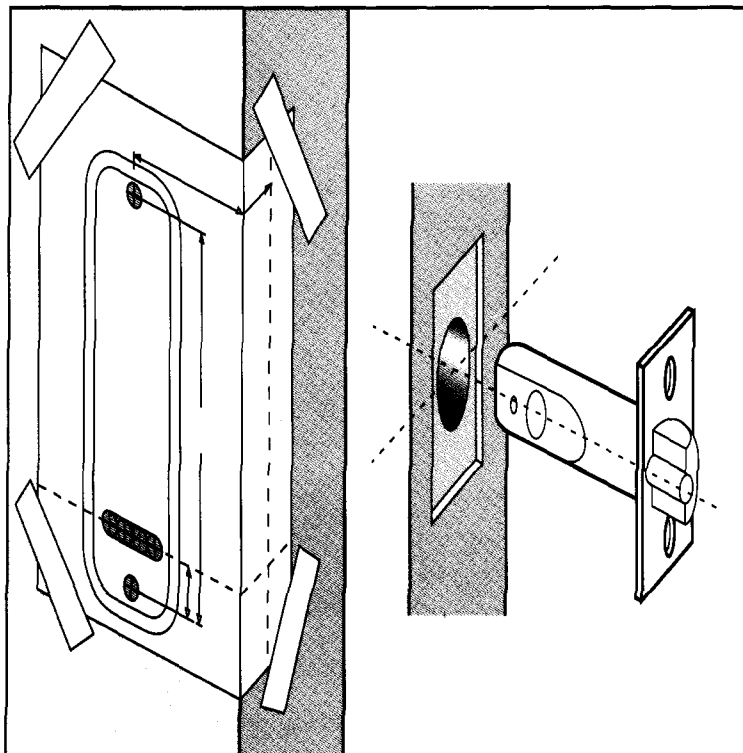

- Tape the template to the door. Make sure that you fold it along the appropriate line, depending on the backset of the latch (60 or 70mm).
- Mark and drill all six 8mm holes.
- Use a chisel to clear the line of 4 x 8mm holes into a single slot.

Positioning and fixing the latch

- Mark a central point on the 'centre line of latch' on the door edge.
- Drill a 25mm hole x 85mm deep.
- Insert the latch into the hole, and draw around the face plate.
- Remove the latch and cut a 3mm rebate so that the face plate will fit flush with the door.
- Secure the latch with the wood screws.

3

LATCH SUPPORT POST

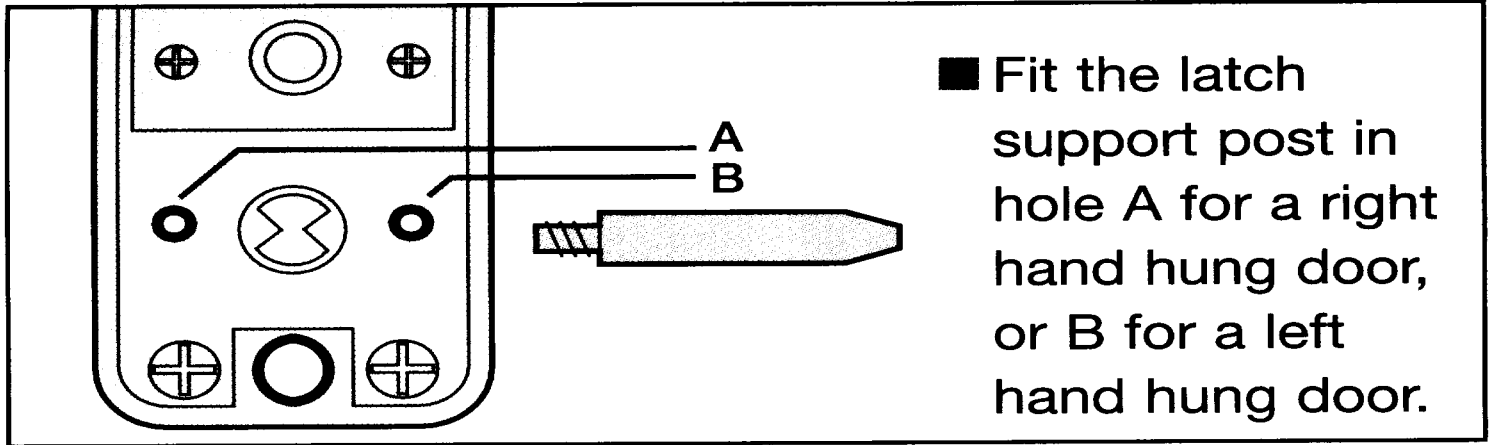

4

2255 BLUE HANDING SCREW

- When fitting a 2255 'hold-open' backplate to a left-hand door the BLUE screw must go in the right-hand hole.

5

POSITIONING THE SPINDLE

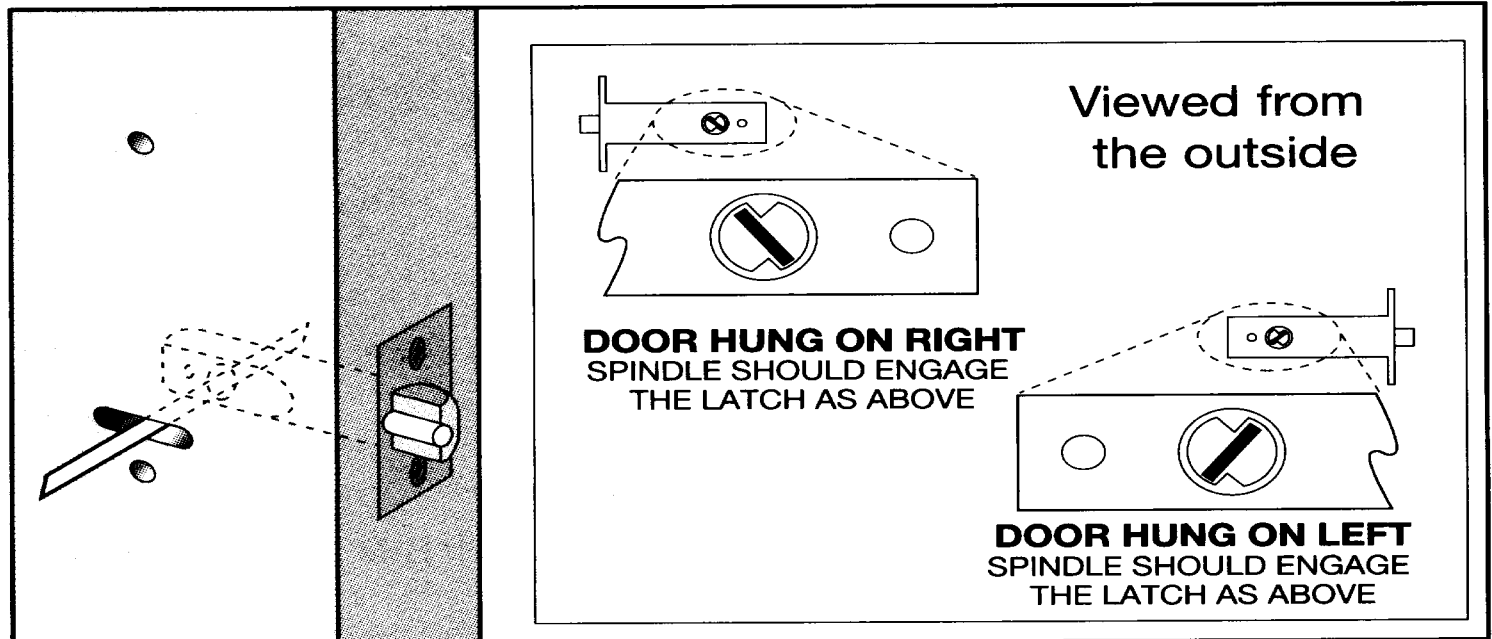

- Select the spindle to suit the thickness of the door.
- Insert the spindle through the slot in the door and make sure that it engages the latch correctly for the hand of the door - (see inset diagram.)

6

FIXING THE LOCK

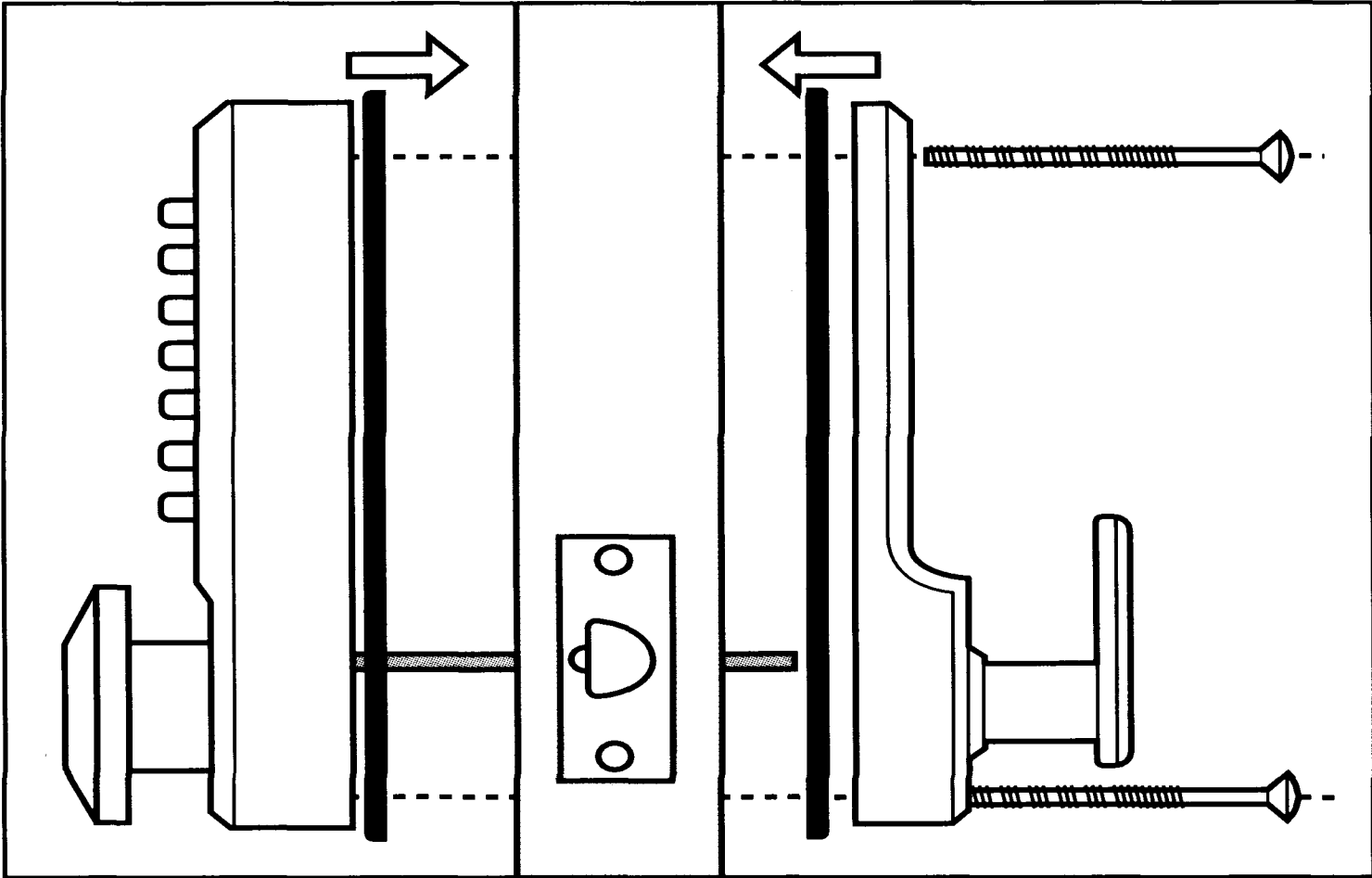

- Cut the fixing bolts to suit the door thickness, allowing at least one threaded section to screw into the lockcase.
- Hold the lock case and the backplate, with the seals, onto the door with the spindle in position.
- Using the fixing bolts screw everything together through the top and bottom holes of the backplate. Before final tightening make sure the lock is vertical, and test the mechanism to ensure that it is all moving easily.

DO NOT CLOSE THE DOOR UNTIL YOU ARE SURE THAT THE CODE WORKS.

DO NOT over tighten the fixing bolts as this may cause distortion and lead to poor operation.

7 FITTING THE STRIKE PLATE

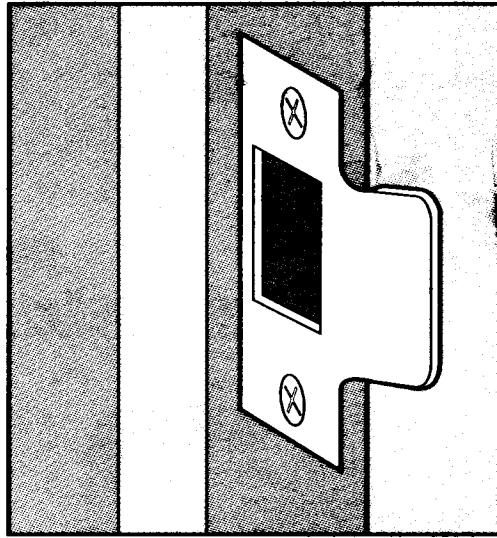
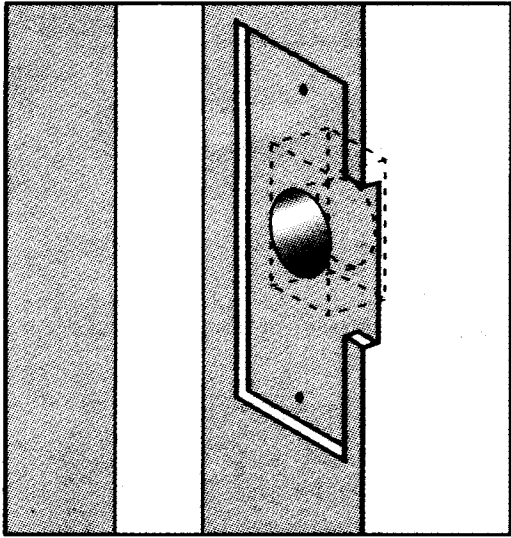

- Position the strike plate on the door so that it lines up with the flat of the latchbolt, NOT THE PLUNGER.
- Mark the inner and outer edges of the strike plate and cut a 1mm rebate so that it fits flush with the surface of the door frame.
- Drill or cut a recess for the latchbolt.
- Fit the strike plate using only one wood screw at first to ensure that it is positioned accurately. The latch bolt, and not the plunger, should enter the aperture easily, and be held without too much 'play'. When satisfied secure the strike with the second screw.

N.B. The plunger beside the latchbolt deadlocks the latchbolt and protects it against manipulation. IT MUST NOT enter the strike plate aperture when the door is closed.

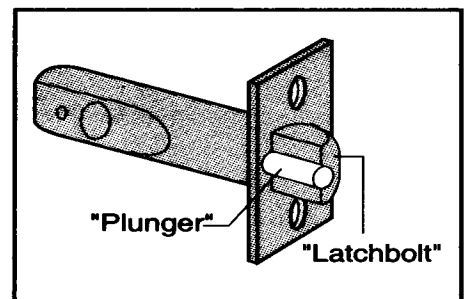

TEMPLATE

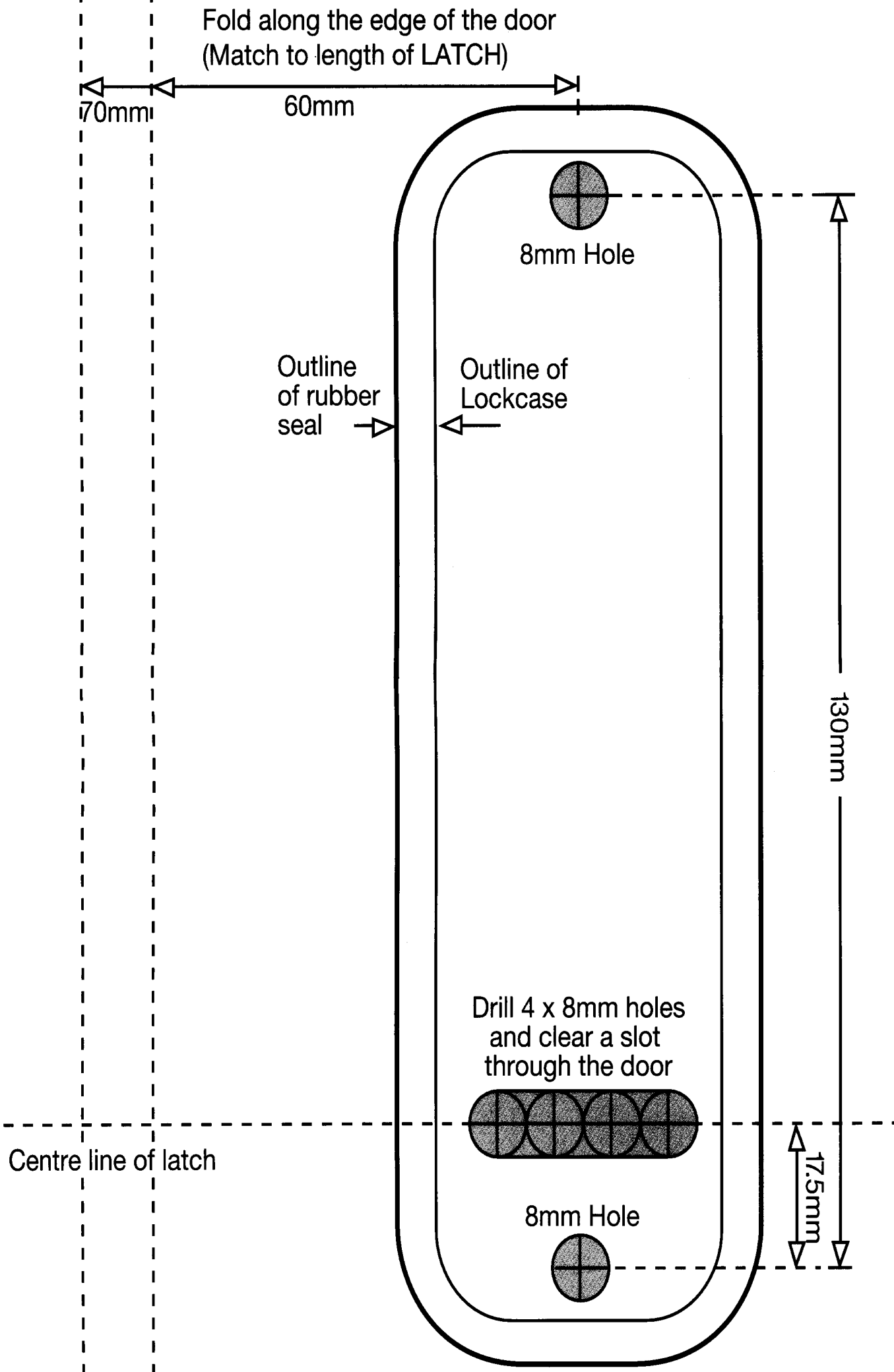

TEMPLATE

