

Contents

- 3 Welcome
- 4 About Partex
- 5 Standards and Testing
- 6 Product overview / Index
- 10 Product Index



Welcome,

We are very proud of our companys dynamic development and how we invest in the future, in new technologies and environmentally friendly solutions.

In addition to our world leading range of identification solutions, we also offer an extensive range of cable ties, terminations, tooling and cable management products.

Partex consists of a parent company and several subsidiaries. However we want to be known as one organisation rather than as several separate companies, We want the family culture and atmosphere of the parent company Partex Gullspang in Sweden, to permeate the entire group, creating one big family.

On the following pages we invite you to familiarise yourself with our company and our products.

If you require a copy of our identification products catalogue, please don't hesitate to contact us.



ABOUT PARTEX



PARTEX MARKING SYSTEMS was founded in 1948 by Tore Lööf in Gullspang Sweden. Since the beginning we have engaged in the production of complete marking systems and cable accessories.

Many of our clients know that Partex is a Swedish company and that we introduced the most popular one-character marker, the PA-Marker. But you should know that our offer is much wider. This catalogue will be a useful guide to the world of cable ties, terminations, tooling and cable management products.

It is worth mentioning that many of our products were established in response to specific requests from our customers. If you have a special requirement, please do not hesitate to contact us.

PARTEX UK



Starting from a small High Street office in 1965 we have grown continuously. Today, still based in Coleshill near Birmingham, we operate from a state of the art 24,000 sq ft facility. Originally trading as an independent company, we were acquired by the Partex group in 1991 and are their oldest subsidiary.

In the UK we take pride in our record of supplying customers worldwide for over five decades with quality cable accessories.

For more than 50 years we have fuelled our growth by offering our customers a personal service, high quality products and competitive pricing. We look forward to being of service to you.



To ensure that all of our products meet the same consistent high quality standard, we subject them to a series of exacting tests, both in-house and at independent test laboratories. This ensures they meet the requirements of the relevant International Standards, such as BS EN and UL certification.

In our UK test laboratory we have equipment that enables us to perform mechanical force tests up to 30KN which means that we can test to destruction our full range of cable terminations, and cable management products.

We are able to provide test reports and calibration certificates upon request.

We can also perform a moisture content inspection on our range of Nylon products to ensure they are perfectly conditioned, strong, flexible and durable.

In line with our ISO9001 certification we operate a strict stock rotation system to ensure that all products reach you in perfect condition.

To meet the requirements of our ISO14001 environmental standard, we strive to minimise our impact upon the environment at all stages of our business activities.





HFC - Nylon Standard

Durable halogen free cable ties made from Nylon 6.6

▶ page 10

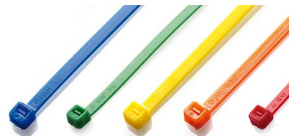

HFC - Nylon Coloured

Coloured halogen free cable ties made from Nylon 6.6

▶ page 12



HFC - UV Resistant

Weatherproof cable ties made from Nylon 6.6

▶ page 13



TT - Tensioning Tools

Automatic hand tools for Nylon cable ties

▶ page 14



MDT - Metal Detectable

Suitable for the food industry made from Nylon 6.6

▶ page 15



HFC - Releasable

Durable halogen free cable ties made from Nylon 6.6

▶ page 16



MAR - Identification Ties

Cable ties with a write on tab made from Nylon 6.6

▶ page 17

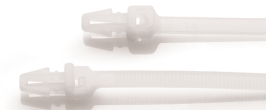

PM - Push Mount

Halogen free cable ties made from Nylon 6.6

▶ page 18



CTF - Cable Tray Ties

Heavy duty cable ties made from Nylon 6.6

▶ page 19



MT - Screw Mountable

Durable halogen free cable ties made from Nylon 6.6

▶ page 20



MB - Metal Barb

Nylon ties with higher strength made from Nylon 6.6

▶ page 21

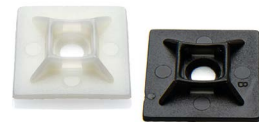

HFC - Tie Bases

Self-adhesive, easy to use made from Nylon 6.6

▶ page 22



SM - Screw Mount Bases

Robust and easy to use made from Nylon 6.6

▶ page 23



R - Nylon Cable Clips

Self-adhesive, easy to use made from Nylon 6.6

▶ page 24



MM - Masonry Mounts

Suitable for outdoor use made from Nylon 6.6

▶ page 25



SST - Standard Ties

Strong roller ball ties made from 316 Stainless steel

▶ page 26



SSTC - Coated Ties

Coated roller ball ties made from 316 Stainless steel

▶ page 27-28



SSTZ - Spring Ties

Strong roller ball ties made from 316 Stainless steel

▶ page 30



SSTCZ - Coated Spring Ties

Coated roller ball ties made from 316 Stainless steel

▶ page 31



SS - Tensioning Tools

Suitable for use with our range of stainless steel roller ball ties

▶ page 32



SSLT - Ladder Ties

Strong ladder ties made from 316 Stainless steel

▶ page 34



SSLTC - Coated Ladder Ties

Coated ladder ties made from 316 Stainless steel

▶ page 35



RRST - Releasable Ties

Strong releasable coated ties made from 316 Stainless steel

▶ page 36



SSTM - Cable Tie Mount

Durable and easy to use, made from 316 Stainless steel

▶ page 37

FLAMEPROOF RANGE OVERVIEW

A brief summary of our flameproof range

▶ page 38



SSTM - Cable Tie Mount

Durable and easy to use, made from 316 Stainless steel.

▶ page 39



SBSW - Conduit Saddle

Epoxy coated steel saddle for fixing round conduit

▶ page 40



MTCC - Mini Trunking Clip

Cable retention clip for Mini-Trunking

▶ page 41

CUTTING TOOLS OVERVIEW

A brief summary of our range of cutting tools

▶ page 42



Wire Cutters

Manual wire and cable cutting tools

▶ page 43-44



Ratchet Cutters

Ratchet operated wire and cable cutters

▶ page 45-46



Armoured Cable Cutters

Suitable for cutting armoured cables and metal bars

▶ page 47



Cable Strippers

Our range of hand operated wire and cable stripping tools

▶ page 48-49

CRIMPING TOOLS OVERVIEW

A brief summary of our range of crimping tools

▶ page 50



CT - Terminal crimpers

For use with our pre-insulated and un-insulated terminals

▶ page 51-53



HSB - Crimper

For use with heat-shrink butt connectors

▶ page 53



CT - Solar crimper

For use with MC3 and MC4 solar connectors

▶ page 53



CT - Hand crimpers

For use with our Copper Tube Connectors

▶ page 54-56



Hydraulic Crimpers

For use with our Copper Tube Connectors

▶ page 57-58



CEF - Crimpers

For use with our range of Bootlace / Cord end ferrules

▶ page 59-61



HG - Hot air gun

For use with our Heatshrink and HSB/SHSB connectors

▶ page 62



Tool Calibration / Repair

Details of this in-house service offered by Partex

▶ page 63



Crimp Terminals
Extensive range of pre-insulated crimp terminals
▶ page 64-70



Angled Crimp Terminals
Pre-insulated crimp terminals bent at right angles or 45 degrees
▶ page 71



Crimp Tool Kits
Kits comprising crimp terminals and a ratchet hand tool
▶ page 72



HSB - Connectors
Heat-shrink butt connectors
▶ page 74



SHSB - Connectors
Solder heat-shrink butt connectors
▶ page 75



Flag Terminals
Pre-insulated flag terminals
▶ page 76



QS - Quick Splice
Insulated quick splice automotive connectors
▶ page 77



Un-insulated
Our range of un-insulated crimp terminals
▶ page 78-80



COL - Range
Copper tube crimp terminals
▶ page 81-83



COL-Butts
Copper tube butt/splice crimp connectors
▶ page 84



PXP PIN TERMINAL
Copper tube pin Crimp connectors
▶ page 85



COL-Angled
Copper tube crimp terminals formed at 90 or 45 degrees
▶ page 86



Copper Tube Tool Kits
Kits comprising copper tube terminals and a ratchet crimper
▶ page 87



PXL - Range
Copper tube crimp terminals
▶ page 89-91



CEF - OVERVIEW
A brief summary of our range of cord-end/boottace ferrules
▶ page 92

CEF - Standard
Our most popular cord-end/boottace ferrules
▶ page 93



CEF - Long Barrel
Longer barrelled cord-end/boottace ferrules
▶ page 94



CEF - Twin
Cord-end/boottace ferrules to accept two cables
▶ page 95



CEF - Un-insulated
Cord-end/boottace ferrules without insulation
▶ page 96



CEF - Tool Kits
Kits comprising cord-end/boottace ferrules and a ratchet crimper
▶ page 97-98



HS - Heat-shrink
2:1 ratio single wall tubing
in a range of sizes and colours

▶ page 100-101



HS - Heat-shrink Kits
Useful packs of assorted
heat-shrink tubing

▶ page 102-103



HSDW - Heat-shrink
3:1 ratio double wall, adhesive
lined tubing

▶ page 104



SUP - Supaflex
Braided sleeving in a range
of sizes and colours

▶ page 106



SW - Spiral wrap
Flexible polyethylene spiral
wrap in a range of sizes

▶ page 107



SP - Spiral Tubing
Robust plastic tubing in a range
of sizes and colours

▶ page 108



IT - Insulation Tape
PVC tape in a range of colours

▶ page 109



TB - Terminal blocks
A range of insulated strip
connectors

▶ page 110



BW CABLE GLAND
Brass armoured cable
Gland for indoor use

▶ page 111



CW CABLE GLAND
Brass armoured cable
Gland for outdoor use

▶ page 112



A1/A2 CABLE GLAND
Brass cable gland for
Unarmoured cables

▶ page 113



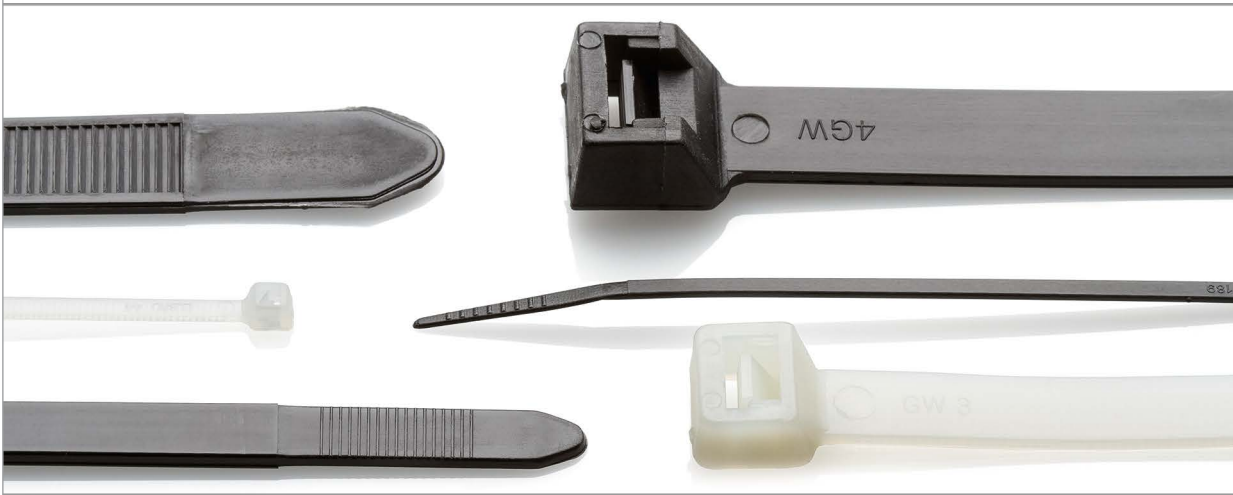

+ INFORMATION

- + Self-locking with high fixing strength.
- + Available for indoor and outdoor installation.
- + Manufactured in accordance with MIL standard M20693B and in conformity with UL94V-2.
- + An extensive range of products to suit many applications.

+ PROPERTIES

Temperature range

-40°C to +85°C

Material

Nylon 6.6, in accordance with UL94-V2
UV resistant ties are also available.

Standard colour

Black and Natural.

Chemical resistance

high resistance to brake fluids, lubricants, power steering fluids, oil, grease, paints, lacquers, detergents, animal and vegetable fats, gasoline and alkalis up to 40%.



File No
E475484



Items marked # are pending approval.

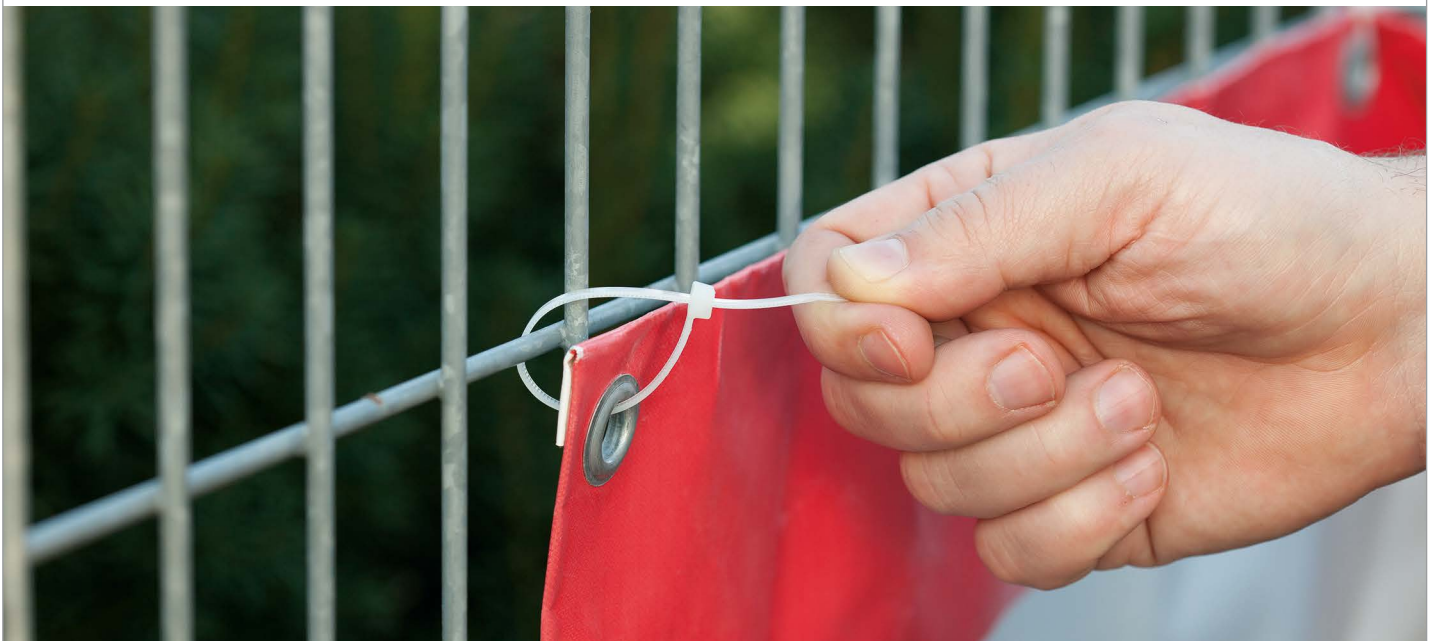

Non-Releasable Nylon 6.6 Cable Ties

TYPE	LENGTH (mm)	WIDTH (mm)	MAX BUNDLE DIAMETER (mm)	MIN. TENSILE STRENGTH (kg)	PACKAGING
HFC 80	80	2.5	15	8	100 or 1000
HFC 100	100	2.5	18	8	100 or 1000
HFC 120	120	4.8	24	22	100
HFC 140	140	3.6	33	18	100
HFC 160	160	4.8	38	22	100
HFC 200	200	4.8	50	22	100
HFC 250	250	4.8	63	22	100
HFC 300	300	4.8	76	22	100
HFC 365	365	4.8	102	22	100
HFC 430	430	4.8	110	22	100
HFC 530	530	4.8	140	22	100
HFC 160L	160	2.5	40	8	100
HFC 200L	200	2.5	50	8	100
HFC 200I	200	3.6	50	18	100
HFC 300L	300	3.6	76	18	100
HFC 150H	150	7.6	36	55	100
HFC 200H	200	7.6	50	55	100
HFC 240H #	240	7.6	66	55	100
HFC 300H	300	7.6	76	55	100
HFC 370H	370	7.6	100	55	100
HFC 430H	430	9.0	110	75	100
HFC 530H	530	9.0	140	75	100
HFC 710H	710	9.0	190	75	100
HFC 940H	940	9.0	280	75	100
HFC 1220H #	1220	9.0	365	75	100
HFC 580EH	580	12.7	152	113	100

Available in both black and natural, please specify required colour when ordering.



COLOURED NYLON CABLE TIES

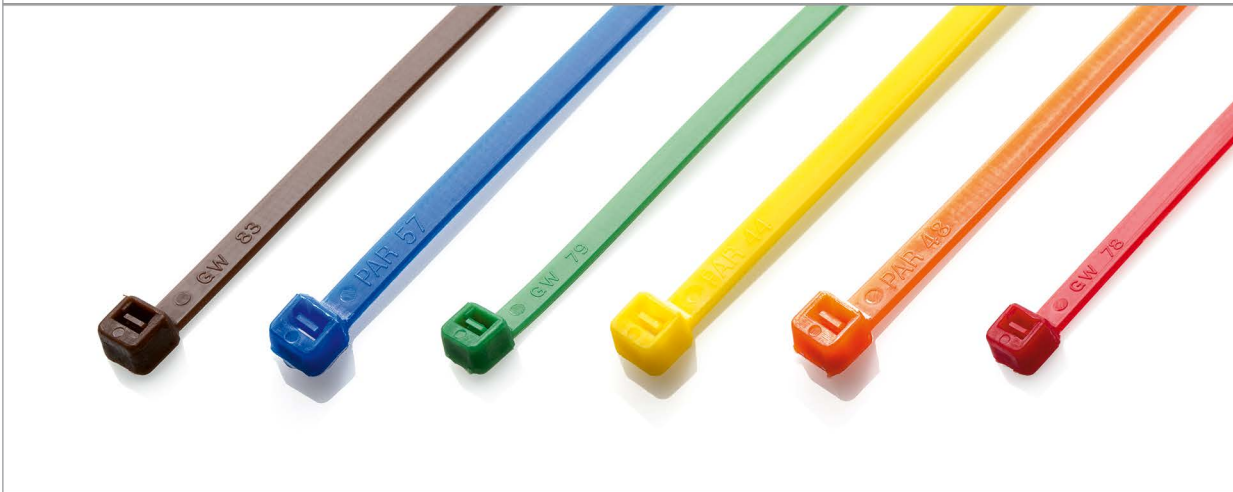

+ INFORMATION

- + Self locking with high fixing strength.
- + An extensive range of colours to suit many applications.
- + Silver and grey ties are ideal for securing wheel trims.

+ PROPERTIES

Temperature range

-40°C to +85°C

Material

Nylon 6.6, in accordance with UL94-V2

Standard colour

As detailed below



File No
E475484



Items marked # are pending approval.

+ DIMENSIONS AND PACKAGING

TYPE	LENGTH (mm)	WIDTH (mm)	MAX BUNDLE DIAMETER (mm)	MIN. TENSILE STRENGTH (kg)	AVAILABLE COLOURS
HFC 100*	100	2.5	18	8	RED, BLU, GRN, BRN, YEL.
HFC 200L*	200	2.5	50	8	RED, BLU, GRN, BRN, YEL.
HFC 140*	140	3.6	33	18	RED, BLU, GRN, BRN, YEL.
HFC 200I*	200	3.6	50	18	BLU.
HFC 200*	200	4.8	50	22	RED, BLU, GRN, BRN, YEL, GRY.
HFC 300*	300	4.8	76	22	RED, BLU, GRN, BRN, YEL, ORG, SLV.
HFC 365*	370	4.8	102	22	RED, BLU, YEL, GRY, SLV.

*Specify colour when ordering. Packaging quantity 100.

+ STANDARD COLOUR



RED



GRN (green)



YEL (yellow)



GRY (grey)



BLU (blue)



BRN (brown)



ORG (orange)



SLV (silver)



+ INFORMATION

- + Self Locking with high fixing strength.
- + UV and weather resistant ties, suitable for use outdoors.
- + Manufactured in accordance with MIL standard M20693B and in conformity with UL94V-2.
- + Only available in black.

+ PROPERTIES

Temperature range

-40°C to +85°C

Material

Nylon 6.6, in accordance with UL94-V2

Standard colour

Black only

Chemical resistance

high resistance to brake fluids, lubricants, power steering fluids, oil, grease, paints, lacquers, detergents, animal and vegetable fats, gasoline and alkalis up to 40%.



File No
E475484



Items marked # are pending approval.

+ DIMENSIONS AND PACKAGING

Ultra-violet Resistant Black Nylon 6.6 Cable Ties

TYPE	LENGTH (mm)	WIDTH (mm)	MAX BUNDLE DIAMETER (mm)	MIN. TENSILE STRENGTH (kg)	PACKAGING
HFC 100 UVB	100	2.5	18	8	100
HFC 140 UVB	140	3.6	33	18	100
HFC 200 UVB	200	4.8	50	22	100
HFC 300 UVB	300	4.8	76	22	100
HFC 365 UVB	365	4.8	102	22	100
HFC 530 UVB #	530	4.8	140	22	100
HFC 160L UVB	160	2.5	40	8	100
HFC 200L UVB	200	2.5	50	8	100
HFC 200I UVB	200	3.6	50	18	100
HFC 300L UVB #	300	3.6	76	18	100
HFC 300H UVB #	300	7.6	76	55	100
HFC 370H UVB	370	7.6	100	55	100
HFC 530H UVB	530	9.0	140	75	100
HFC 710H UVB	710	9.0	190	75	100
HFC 1030EH UVB #	1030	12.7	302	113	50

Only available in black.

TENSIONING TOOLS FOR NYLON CABLE TIES



+ INFORMATION

- + Designed to complement our range of Nylon cable ties
- + Easy to use, one hand operation
- + Tensions the cable tie, and then trims off the end leaving no sharp edges

+ PRODUCT RANGE



TT1

Hand held cable tie tensioning tool with auto cut mechanism for use with standard Nylon cable ties from 2.5mm up to 4.8mm wide, with adjustable tensioning setting

Specification:

Frame: Diecast steel

Length: 155mm.

Weight: 0.3kgs.



TT3

Hand held manual operated cable tie tensioning tool with auto cut mechanism for use with standard Nylon cable ties from 3.6mm up to 9mm wide.

Specification:

Frame: Steel SPCC

Length: 195mm.

Weight: 0.3kgs.



TT4

Hand held manual operated cable tie tensioning tool with auto cut mechanism for use with standard Nylon cable ties from 4.8mm up to 13mm wide.

Specification:

Frame: Steel SPCC

Length: 200mm.

Weight: 0.32kgs.



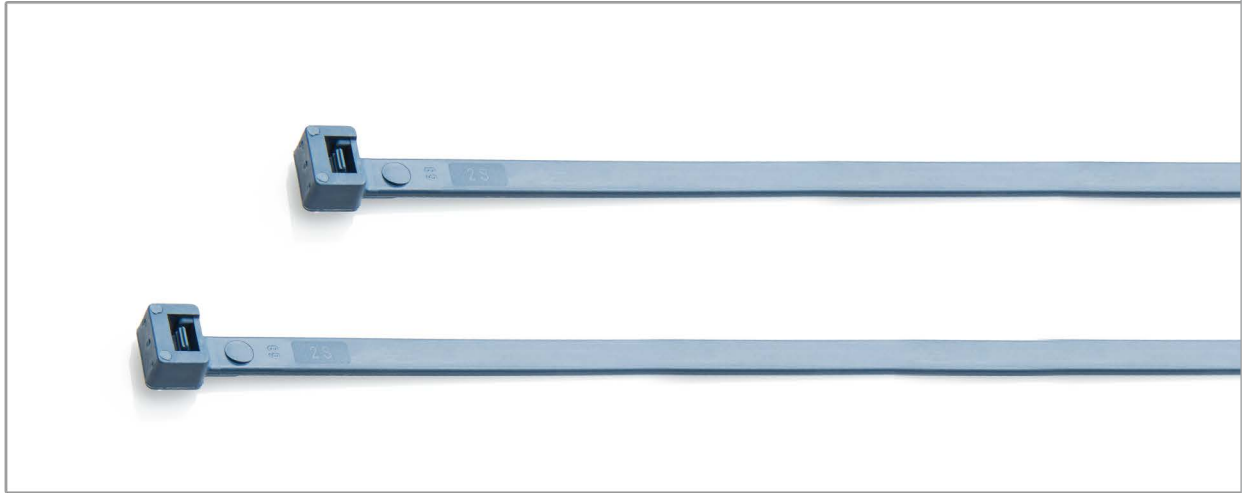

+ INFORMATION

- + Recommended for use in food, pharmaceutical and chemical industry.
- + Self Locking with high fixing strength.
- + Metal content spread throughout the tie enabling them to be located by standard metal detectors.
- + The blue colour assists in visual detection and reduces the risk of contamination.

+ PROPERTIES

Temperature range
-25°C to +100°C

Standard colour
Blue (RAL 5002)

Material
Nylon self extinguishing UL94 HB
Non toxic, recyclable. Halogen free.

+ DIMENSIONS AND PACKAGING

TYPE	LENGTH (mm)	WIDTH (mm)	MAX BUNDLE DIAMETER (mm)	MIN. TENSILE STRENGTH (kg)	PACKAGING
MDT 100	100	2.5	24	10	100
MDT 140I	140	3.5	36	20	100
MDT 200	200	4.5	51	28	100
MDT 280	280	4.5	76	28	100
MDT 380	380	4.5	110	28	100
MDT 360H	360	7.5	100	55	100

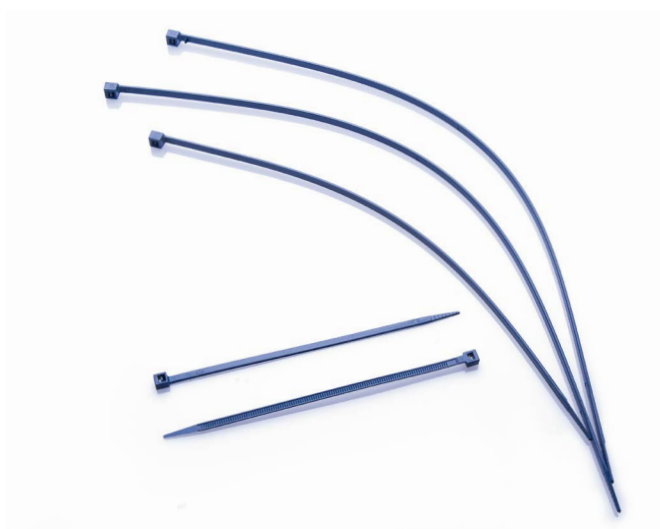

RELEASABLE NYLON CABLE TIES

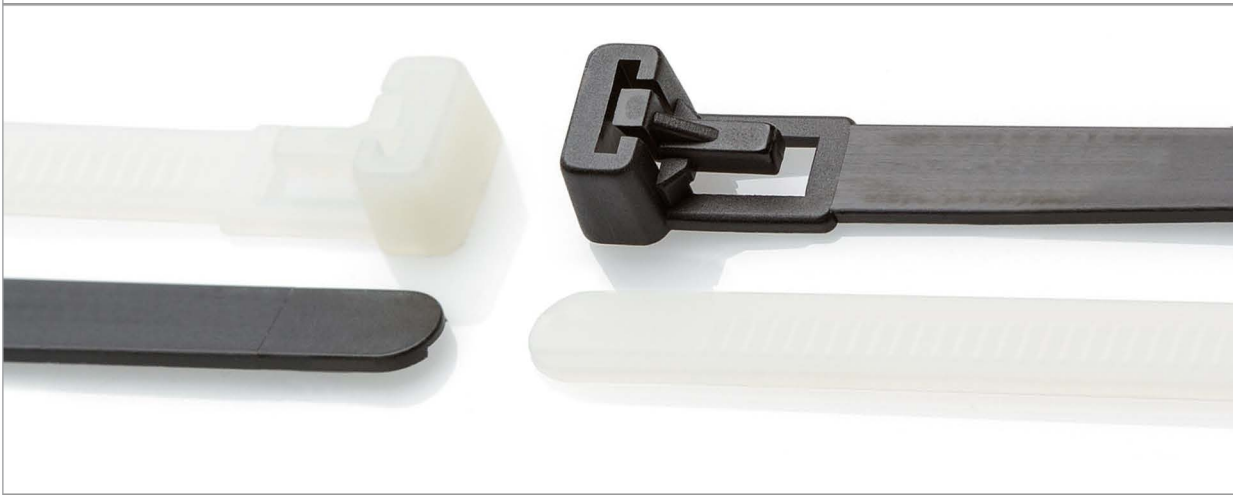

+ INFORMATION

- + Can be released and reused many times.
- + Sturdy and secure locking mechanism.
- + Suitable for temporary or permanent use.
- + Good chemical resistance.

+ PROPERTIES

Temperature range

-40°C to +85°C

Material

Nylon 66, self extinguishing UL94 V2
Non toxic, recyclable. Halogen free.

Standard colour

Black and Natural

Chemical resistance

high resistance to brake fluids, lubricants, power steering fluids, oil, grease, paints, lacquers, detergents, animal and vegetable fats, gasoline and alkalis up to 40%.

+ DIMENSIONS AND PACKAGING

TYPE	LENGTH (mm)	WIDTH (mm)	MAX BUNDLE DIAMETER (mm)	MIN. TENSILE STRENGTH (kg)	PACKAGING
HFCR 200H	200	7.6	50	22	100
HFCR 300H	300	7.6	80	22	100
HFCR 370H	370	7.6	102	22	100

Available in both black and natural, please specify required colour when ordering.

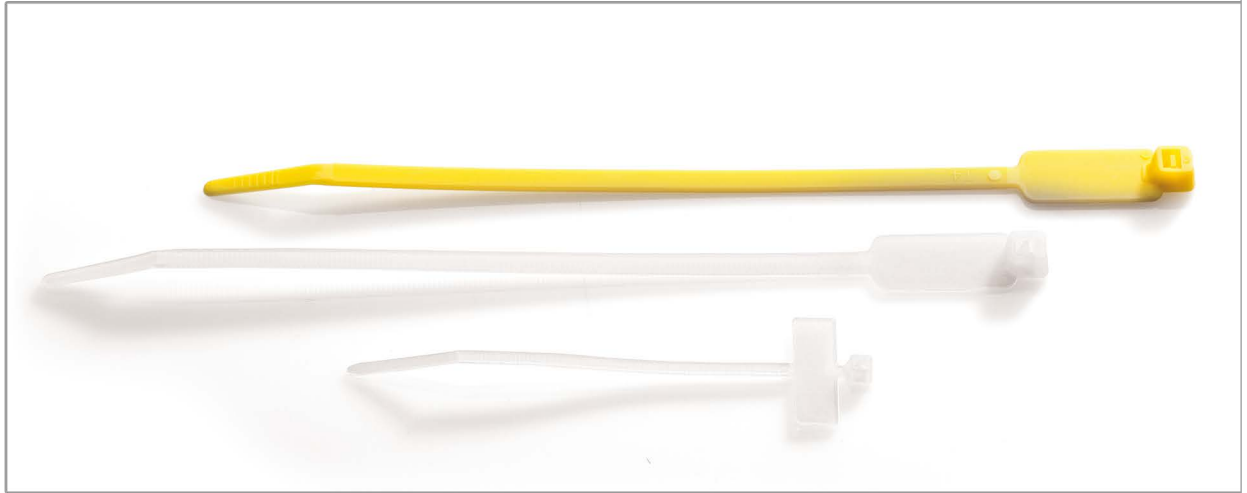

+ INFORMATION

- + Self locking with high fixing strength.
- + Ideal for securing and identifying bundles of cables.
- + Good chemical resistance.
- + Can be marked using an indelible pen, or by attaching a self-adhesive label.

+ PROPERTIES

Temperature range

-40°C to +85°C

Material

DuPont Zytel 101F Nylon 6.6 Polyamide
Self-extinguishing to UL 94-V2

Standard colour

As detailed below

Chemical resistance

high resistance to brake fluids, lubricants, power steering fluids, oil, grease, paints, lacquers, detergents, animal and vegetable fats, gasoline and alkalis up to 40%.



File No
E475484



Items marked # are pending approval.

+ DIMENSIONS AND PACKAGING

TYPE	LENGTH (mm)	WIDTH (mm)	MAX BUNDLE DIAMETER (mm)	MIN. TENSILE STRENGTH (kg)	AVAILABLE COLOURS
MAR 100F	98	2.5	20	8	NATURAL
MAR 110F	110	2.5	20	8	NATURAL
MAR 200W #	194	2.5	45	22	NAT/YELLOW

Available in packs of 100.

+ DRAWING

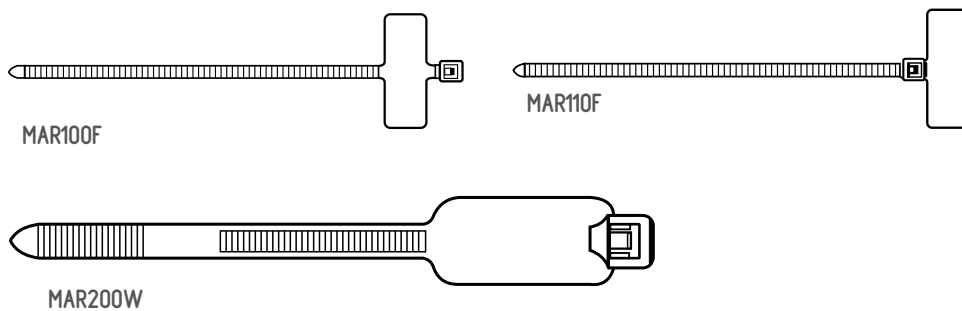

+ RELATED PRODUCTS



TIE PEN

PUSH MOUNT NYLON CABLE TIES

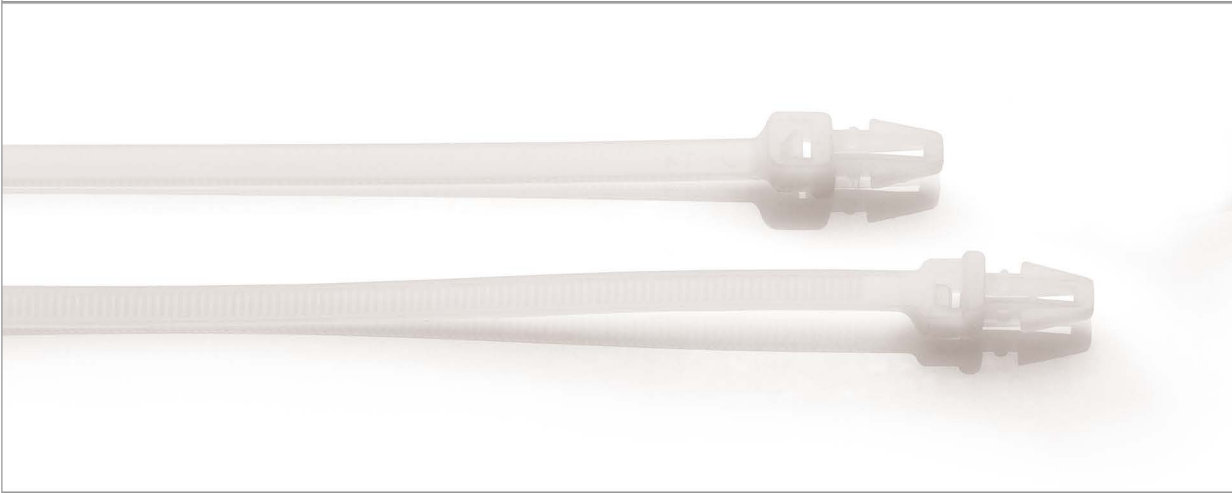

INFORMATION

- + Provides a simple and secure method for securing bundles of cables into a fixing hole.
- + Sturdy and secure locking mechanism
- + No additional fixings required.
- + Good chemical resistance.



PROPERTIES

Temperature range

-40°C to +85°C

Material

Nylon 66, self extinguishing UL94 V2
Non toxic, recyclable. Halogen free.

Standard colour

Natural only

Chemical resistance

high resistance to brake fluids, lubricants, power steering fluids, oil, grease, paints, lacquers, detergents, animal and vegetable fats, gasoline and alkalis up to 40%.



DIMENSIONS AND PACKAGING

TYPE	LENGTH (mm)	WIDTH (mm)	MAX BUNDLE DIAMETER (mm)	MIN. TENSILE STRENGTH (kg)	MAXIMUM PANEL THICKNESS (mm)	NOMINAL HOLE DIAMETER (mm)
PM 150	150	3.6	32	18	2.4	4.8
PM 200	200	4.8	50	22	3.2	6.5

Available in packs of 100

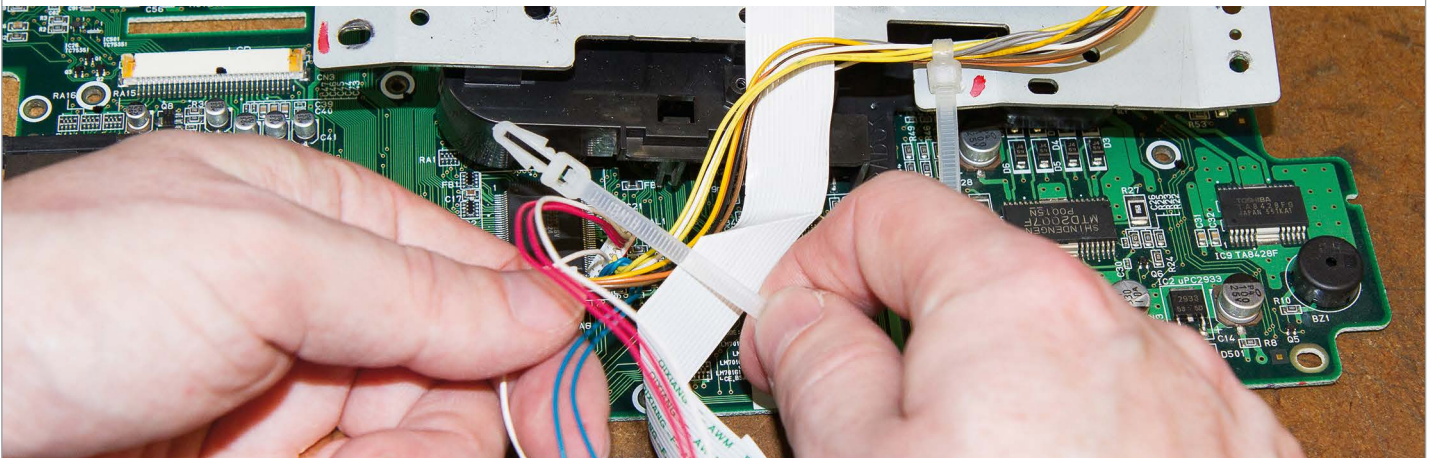



+ INFORMATION

- + Self locking with high fixing strength.
- + Ideal for securing bundles of cables directly onto cable tray.
- + Perfect for when access is limited.
- + Two part construction makes mounting very easy.

+ PROPERTIES

Temperature range

-40°C to +85°C

Material

DuPont Zytel 101F Nylon 6.6 Polyamide
Self-extinguishing to UL 94-V2

Standard colour

As detailed below

Chemical resistance

high resistance to brake fluids, lubricants, power steering fluids, oil, grease, paints, lacquers, detergents, animal and vegetable fats, gasoline and alkalis up to 40%.

+ DIMENSIONS AND PACKAGING

TYPE	LENGTH (mm)	WIDTH (mm)	MIN. TENSILE STRENGTH (kg)	STRAP LENGTH (mm)	BUCKLE LENGTH (mm)
CTF320 Black	320	7.6	55	270	24
CTF320 Natural	320	7.6	55	270	24

Available in packs of 100

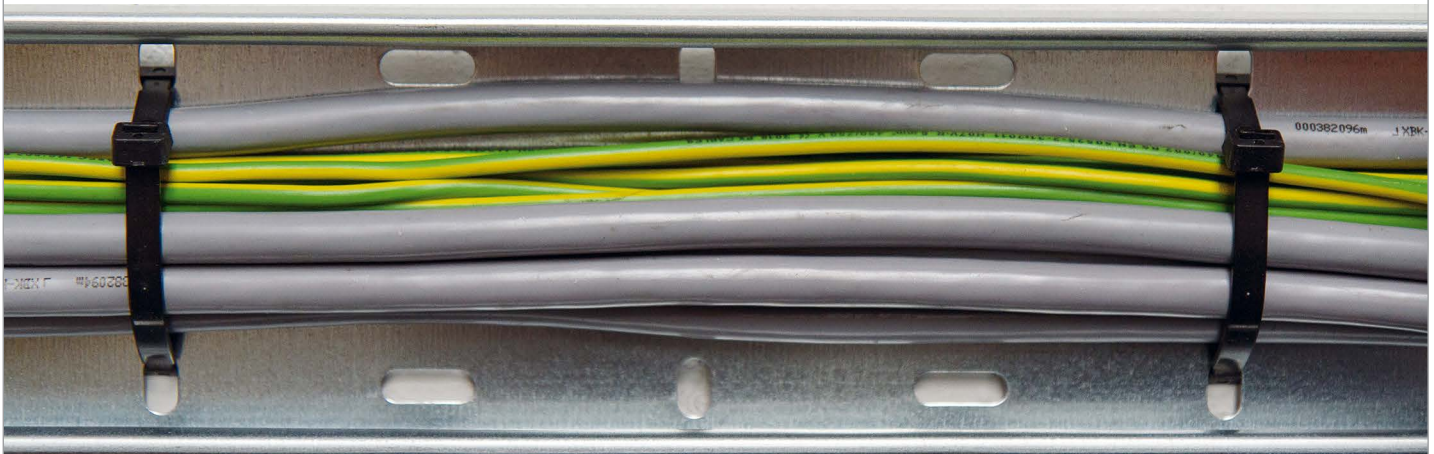

SCREW MOUNTABLE NYLON CABLE TIES



+ INFORMATION

- + Provides a simple and secure method for securing bundles of cables into a fixing hole.
- + Sturdy and secure locking mechanism
- + Good chemical resistance.

+ PROPERTIES

Temperature range

-40°C to +85°C

Material

Nylon 66, self extinguishing UL94 V2
Non toxic, recyclable. Halogen free.

Standard colour

Natural and black

Chemical resistance

high resistance to brake fluids, lubricants, power steering fluids, oil, grease, paints, lacquers, detergents, animal and vegetable fats, gasoline and alkalis up to 40%.



File No
E475484



Items marked # are pending approval.

+ DIMENSIONS AND PACKAGING

TYPE	LENGTH (mm)	WIDTH (mm)	MAX BUNDLE DIAMETER (mm)	MIN. TENSILE STRENGTH (kg)	FIXING HOLE DIAMETER (mm)	PACKAGING
MT 110 Natural #	100	2.5	18	8	3.2	100
MT 150 Natural	150	3.6	32	18	4.2	100
MT 200 Natural	200	4.8	50	22	5.2	100
MT 200 Black	200	4.8	50	22	5.2	100
MT 300 Natural #	305	7.6	76	55	6.2	100
MT 300 Black #	305	7.6	76	55	6.2	100

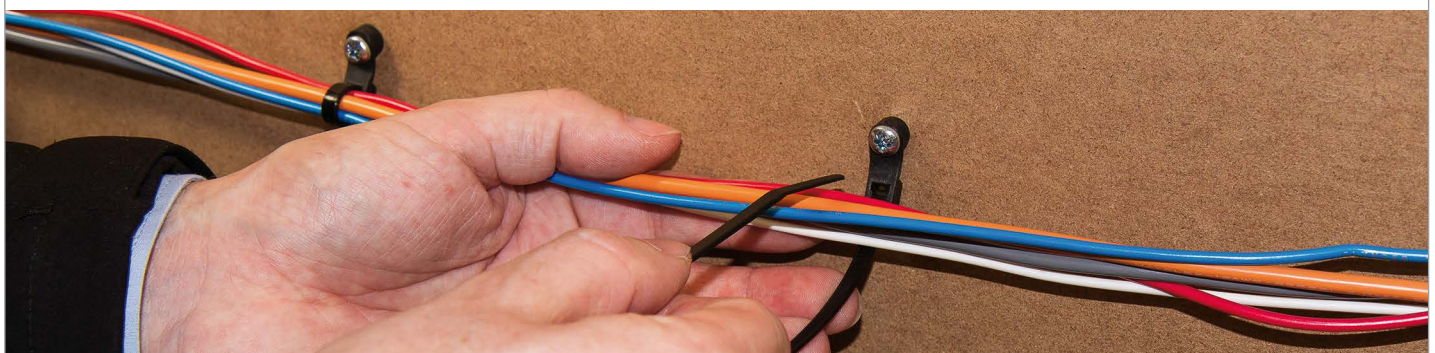

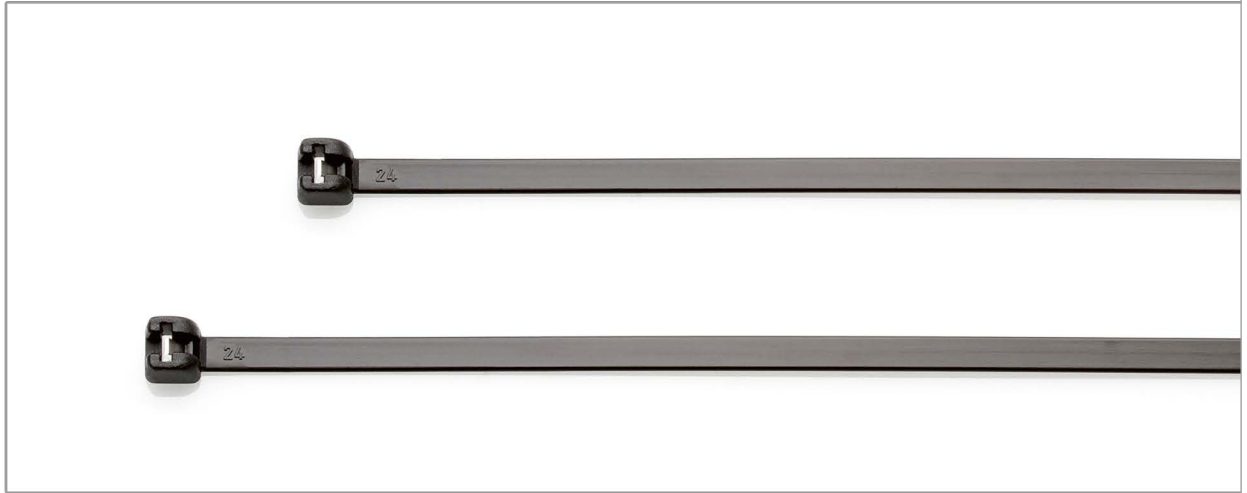

+ INFORMATION

- + Steel tooth for additional tensile strength.
- + Ideal for securing bundles of cables.
- + Good chemical resistance.
- + Smooth Nylon band to reduce abrasion.

+ PROPERTIES

Temperature range

-40°C to +85°C

Material

Nylon 6.6 Polyamide
Self-extinguishing to UL 94-V2

Standard colour

Natural and black

Chemical resistance

high resistance to brake fluids, lubricants, power steering fluids, oil, grease, paints, lacquers, detergents, animal and vegetable fats, gasoline and alkalis up to 40%. Black ties are UV resistant.

+ DIMENSIONS AND PACKAGING

TYPE	LENGTH (mm)	WIDTH (mm)	MAX BUNDLE DIAMETER (mm)	MIN. TENSILE STRENGTH (kg)	PACKAGING
MB100	100	2.5	24	18	1000
MB140	140	3.5	36	28	1000
MB200I	200	3.5	55	28	100
MB280I	280	3.5	80	28	100
MB360I	360	3.5	101	28	100
MB200	186	4.5	51	40	100
MB300	290	4.5	80	40	100
MB360	360	4.5	103	40	100
MB340H	340	7.0	90	70	50
MB360H	360	7.5	101	80	50

Available in both black and natural, please specify required colour when ordering.

HFC - CABLE TIE BASES



INFORMATION

- + Designed to compliment our range of Nylon cable ties.
- + Four entry design, for ease of use
- + High tack self-adhesive backing
- + Black bases are UV stable and suitable for external use



PROPERTIES

Temperature range

-20°C to +60°C

Material

Base: Nylon 6.6 (Polyamide)
Backing: White polythene foam
Adhesive: Synthetic rubber

Standard colour

Black and Natural

Packaging

Bags of 100



DIMENSIONS

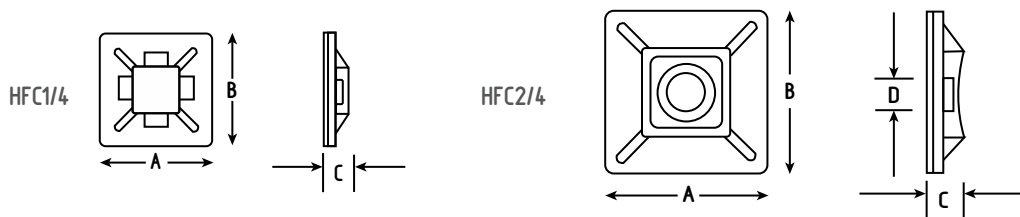

PART NUMBER	DIMENSIONS A x B (mm)	HEIGHT [C] (mm)	FIXING HOLE [D] (mm)	MAXIMUM TIE WIDTH (mm)
HFC1/ 4 BLK	20x20	5.0	n/a	4.5
HFC1/ 4 NAT	20x20	5.0	n/a	4.5
HFC2/4 BLK	28x28	7.1	(M 6)	5.5
HFC2/4 NAT	28x28	7.1	(M 6)	5.5

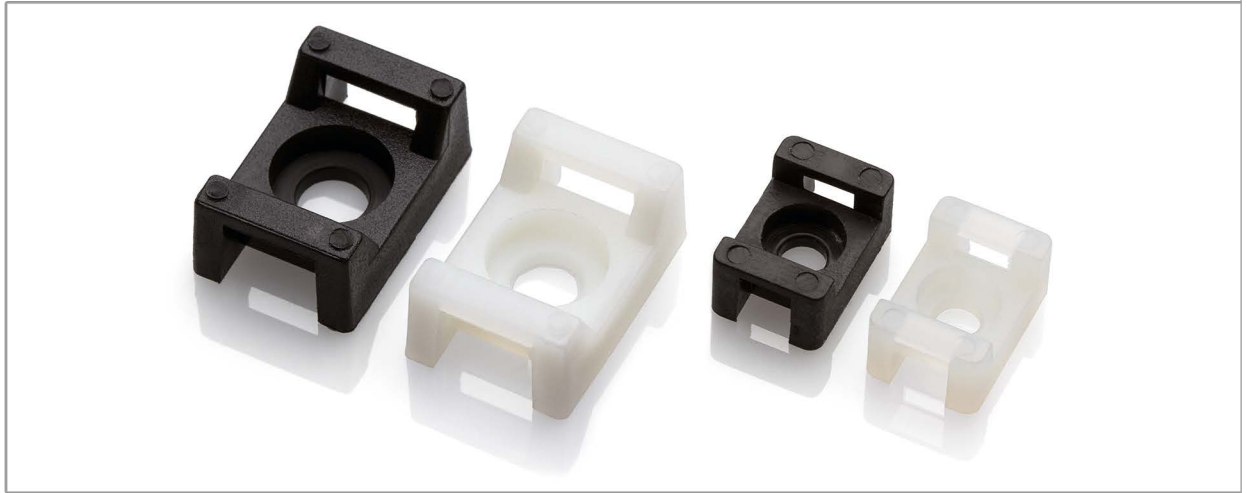

+ INFORMATION

- + Designed to compliment our range of nylon cable ties
- + Single fixing hole, for ease of use
- + Robust and secure design
- + A cost effective solution for mounting cable ties

+ PROPERTIES

Working Temperature range

-40°C to +85°C

Packaging

Bags of 100

Material

Nylon 6.6 (Polyamide)

+ DIMENSIONS

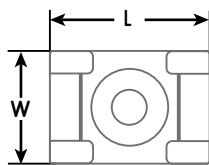

SM2/3

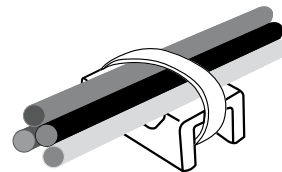
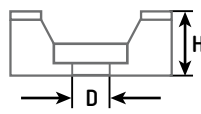

PART NUMBER	DIMENSIONS (mm)			HOLE	MAXIMUM TIE WIDTH
	LENGTH [L]	WIDTH [W]	HEIGHT [H]		
SM2 *	15.8	10.3	7.0	M4	4.8
SM3 *	23.4	15.7	9.5	M6	9.0

Available in both black and natural, please specify required colour when ordering.

SELF-ADHESIVE CABLE CLIPS



+ INFORMATION

- + A simple and cost effective method for securing cables.
- + Manufactured from durable Nylon.
- + High tack self-adhesive backing.
- + Available in a range of sizes.

+ PROPERTIES

Temperature range

-20°C to +60°C

Material

Base: Nylon 6.6 (Polyamide)
Backing: White polythene foam
Adhesive: Synthetic rubber

Standard colour

Black and Natural

Packaging

Bags of 100

+ DIMENSIONS

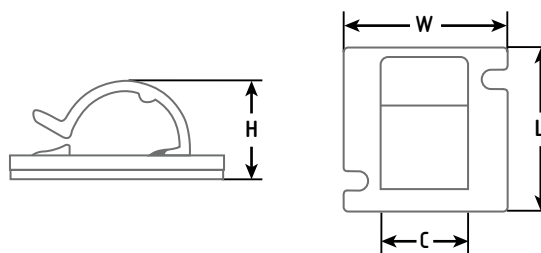

PART NUMBER	COLOUR	DIMENSIONS (mm)				MINIMUM BUNDLE DIA (mm)	MAXIMUM BUNDLE DIA (mm)	SCREW FIXING (optional)
		LENGTH [L]	WIDTH [W]	HEIGHT [H]	CLIP WIDTH [C]			
R161N/1	Natural	16	16	7.0	10.7	4.0	5.0	n/a
R161B/1	Black	16	16	7.0	10.7	4.0	5.0	n/a
R251N/1	Natural	25	25	10.9	12.7	8.0	13.0	2 x M3
R251B/1	Black	25	25	10.9	12.7	8.0	13.0	2 x M3
R281N/1	Natural	28	28	16	14	12.0	18.0	2 x M3
R281B/1	Black	28	28	16	14	12.0	18.0	2 x M3



INFORMATION

- + Designed to compliment our range of Nylon cable ties
- + A quick and efficient method for securing cables or pipework
- + Quick and easy to install, simply push into a pre-drilled hole, and secure your cables with a nylon tie.
- + Fully weather and UV resistant, suitable for external use



PROPERTIES

Working Temperature range

-40°C to +85°C

Standard colour

Black

Material

Black Nylon 6.6 (Polyamide)

Packaging

Bags of 100



DIMENSIONS

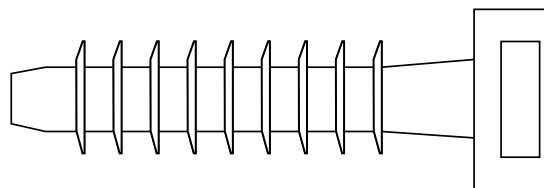

PART NUMBER	LENGTH (mm)	FIXING HOLE DEPTH (mm)	FIXING HOLE DIAMETER (mm)	MAXIMUM TIE WIDTH (mm)
MM6	44	38.0	6.0	9.0
MM7	44	38.0	7.0	9.0

STAINLESS STEEL CABLE TIES



+ INFORMATION

- + Cable ties made from stainless steel AISI 316
- + Great for restraining harnesses and cables. Quick and safe installation in a variety of applications.
- + Easy to clamp with Partex's tools: SSTG or SSAT
- + Excellent resistance to acids, salt, chemicals, and high temperatures

+ PROPERTIES

Temperature range
-80°C to +500°C

Material
316 Stainless steel, Non toxic, recyclable.
Halogen free, flameproof, UV resistant.



File No
E475484



Items marked # are pending approval.

+ DIMENSIONS AND PACKAGING

1) Free Position

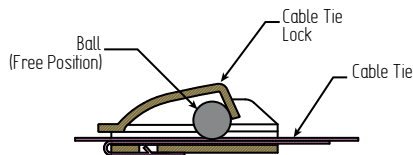

2) Locking Position

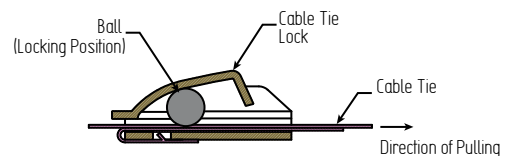

TYPE	LENGTH (mm)	WIDTH (mm)	MAX BUNDLE DIAMETER (mm)	MIN. TENSILE STRENGTH (N)	PACKAGING
SST 1316	150	4.6	37	667	100
SST 2316	200	4.6	50	667	100
SST 3316 #	260	4.6	69	667	100
SST 3816 #	300	4.6	85	667	100
SST 4316	360	4.6	100	667	100
SST 5316	520	4.6	150	667	100
SST 6316 #	680	4.6	200	667	100
SST 2316H	200	7.9	50	1335	100
SST 3316H #	260	7.9	69	1335	100
SST 3816H #	300	7.9	85	1335	100
SST 4316H	360	7.9	100	1335	100
SST 5316H	520	7.9	150	1335	100
SST 6316H #	680	7.9	200	1335	100
SST 8316H	840	7.9	250	1335	100
SST 10316H	1000	7.9	300	1335	100

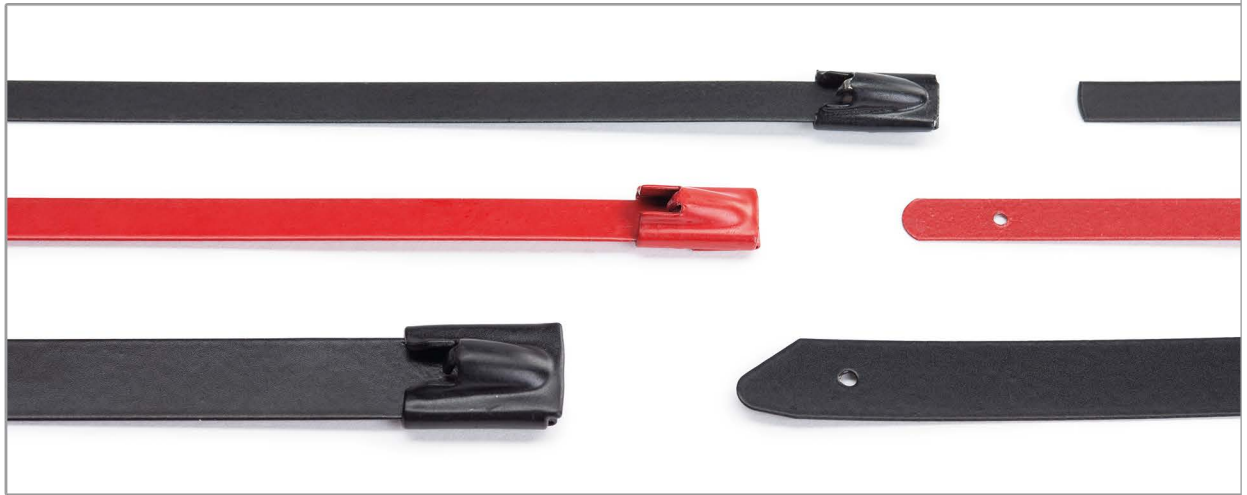

+ INFORMATION

- + Cable ties made from stainless steel AISI 316, coated with black or red polyester.
- + A very strong ball lock.
- + Quick and safe installation in a variety of applications.
- + The outer layer of polyester and gently rounded edges protect the cable from damage.
- + Excellent resistance to acids, salt, chemicals, and high temperatures.

+ PROPERTIES

Temperature range
-80°C to +150°C

Material
316 Stainless steel, with pure polyester coating
Non toxic, recyclable. Halogen free.



File No
E475484



Items marked # are pending approval.

+ DIMENSIONS AND PACKAGING

TYPE	LENGTH (mm)	WIDTH (mm)	MAX BUNDLE DIAMETER (mm)	MIN. TENSILE STRENGTH (N)	COLOUR	PACKAGING
SSTC 0316	100	4.6	18	667	BLACK COATED	100
SSTC 1316	150	4.6	37	667		100
SSTC 2316	200	4.6	50	667		100
SSTC 3316 #	260	4.6	69	667		100
SSTC 3816 #	300	4.6	85	667		100
SSTC 4316	360	4.6	100	667		100
SSTC 4816 #	450	4.6	125	667		100
SSTC 5316	520	4.6	150	667		100
SSTC 6316 #	680	4.6	200	667		100
SSTC 1316H	150	7.9	34	1335		100
SSTC 2316H	200	7.9	50	1335		100
SSTC 3316H #	260	7.9	69	1335		100
SSTC 3816H #	300	7.9	85	1335		100
SSTC 4316H	360	7.9	100	1335		100
SSTC 4816H #	450	7.9	125	1335		100
SSTC 5316H	520	7.9	150	1335		100
SSTC 6316H #	680	7.9	200	1335		100
SSTC 8316H	840	7.9	250	1335		100
SSTC 10316H	1000	7.9	300	1335		100
SSTRC 2316	200	4.6	50	667		RED COATED
SSTRC 4316	360	4.6	100	667	100	

STAINLESS STEEL CABLE TIES, NYLON 11 COATED

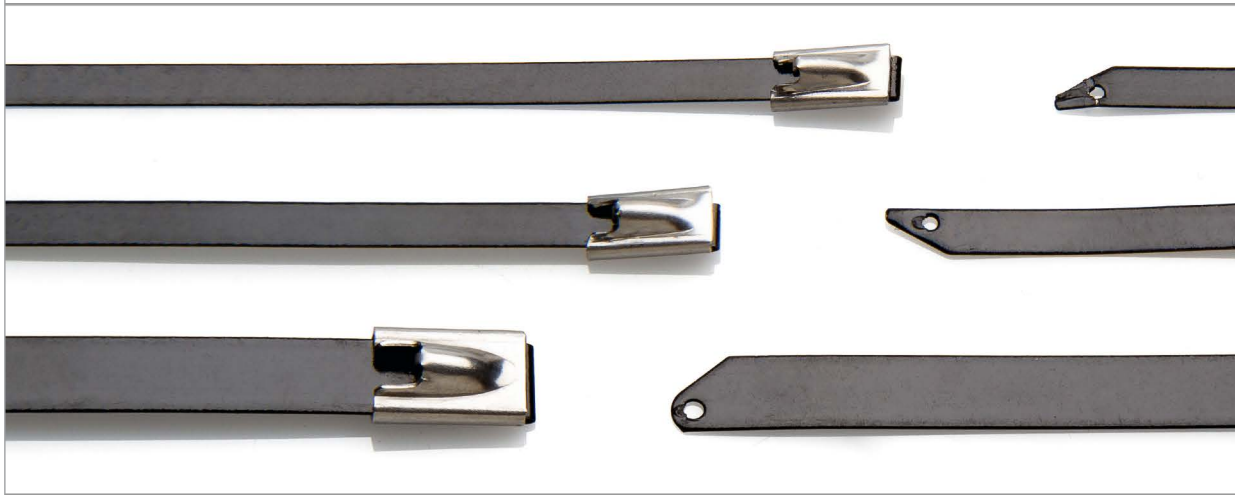

INFORMATION

- + Cable ties made from stainless steel AISI 316, coated with black Nylon 11.
- + A very strong ball lock.
- + Quick and safe installation in a variety of installations.
- + The outer layer of Nylon 11 and gently rounded edges protect the cable from damage.
- + UV Resistant, highly acid resistant.



PROPERTIES

Temperature range
-105°C to +150°C

Material
316 Stainless steel, with pure Nylon 11 coating,
Non-toxic, recyclable, low smoke, halogen free.



DIMENSIONS AND PACKAGING

TYPE	LENGTH (mm)	WIDTH (mm)	MAX BUNDLE DIAMETER (mm)	MIN. TENSILE STRENGTH (N)	COLOUR	PACK QUANTITY
SSTC 0316-N	100	4.6	18	667	black coated	100
SSTC 1316-N	150	4.6	37	667		100
SSTC 2316-N	200	4.6	50	667		100
SSTC 3316-N	260	4.6	69	667		100
SSTC 3816-N	300	4.6	85	667		100
SSTC 4316-N	360	4.6	100	667		100
SSTC 5316-N	520	4.6	150	667		100
SSTC 1316H-N	150	7.9	34	1335		100
SSTC 2316H-N	200	7.9	50	1335		100
SSTC 3316H-N	260	7.9	69	1335		100
SSTC 3816H-N	300	7.9	85	1335		100
SSTC 4316H-N	360	7.9	100	1335		100
SSTC 5316H-N	520	7.9	150	1335		100



STAINLESS STEEL SPRING CABLE TIES



+ INFORMATION

- + Cable ties made from stainless steel AISI 316
- + Spring form maintains a greater tension on solid objects
- + Easy to clamp with Partex's tools: SSTG or SSAT
- + Excellent resistance to acids, salt, chemicals, and high temperatures

+ PROPERTIES

Temperature range
-80°C to +500°C

Material
316 Stainless steel, Non toxic, recyclable.
Halogen free, flameproof, UV resistant.

+ DIMENSIONS AND PACKAGING

TYPE	LENGTH (mm)	WIDTH (mm)	MAX BUNDLE DIAMETER (mm)	MIN. TENSILE STRENGTH (N)	PACKAGING
SSTZ 2316	200	4.6	50	667	100
SSTZ 3316	260	4.6	69	667	100
SSTZ 3816	300	4.6	85	667	100
SSTZ 4316	360	4.6	100	667	100
SSTZ 5316	520	4.6	150	667	100
SSTZ 2316H	200	7.9	50	1335	100
SSTZ 3316H	260	7.9	69	1335	100
SSTZ 3816H	300	7.9	85	1335	100
SSTZ 4316H	360	7.9	100	1335	100
SSTZ 5316H	520	7.9	150	1335	100





+ INFORMATION

- + Cable ties made from stainless steel AISI 316, coated with black or red polyester.
- + Spring form maintains a greater tension on solid objects.
- + The outer layer of polyester and gently rounded edges protect the cable from damage.
- + Excellent resistance to acids, salt, chemicals, and high temperatures.

+ PROPERTIES

Temperature range
-80°C to +150°C

Material
316 Stainless steel, with pure polyester coating
Non toxic, recyclable. Halogen free.

+ DIMENSIONS AND PACKAGING

TYPE	LENGTH (mm)	WIDTH (mm)	MAX BUNDLE DIAMETER (mm)	MIN. TENSILE STRENGTH (N)	PACKAGING
SSTCZ 2316	200	4.6	50	667	100
SSTCZ 3316	260	4.6	69	667	100
SSTCZ 3816	300	4.6	85	667	100
SSTCZ 4316	360	4.6	100	667	100
SSTCZ 5316	520	4.6	150	667	100
SSTCZ 2316H	200	7.9	50	1335	100
SSTCZ 3316H	260	7.9	69	1335	100
SSTCZ 3816H	300	7.9	85	1335	100
SSTCZ 4316H	360	7.9	100	1335	100
SSTCZ 5316H	520	7.9	150	1335	100





+ INFORMATION

- + Designed to complement our range of stainless steel cable ties
- + Easy to use, reducing installation time
- + Tensions the ties, and then trims off the end.

+ PRODUCT RANGE



SSTG

- + Automatically tightens and cuts off the tie when it reaches the required tension.
- + Adjustable tension setting.
- + Ergonomic handle reduces operator fatigue.
- + Can be used with one hand.
- + Can be used for both coated and uncoated ties up to 7.9mm wide.
- + Only suitable for stainless steel roller ball cable ties.

Specification:

Frame: Steel grade S45C
Handle grips: Polypropylene
Length: 180mm.
Weight: 0.56kgs.



SSAT

- + A semi-automatic tool which tightens the tie to the required tension with a manual cutting mechanism.
- + Two hand operation.
- + Easy to use and very robust it is ideal for higher volume applications.
- + Can be used for both coated and uncoated ties up to 7.6mm wide.
- + Only suitable for stainless steel cable ties.

Specification:

Frame: Steel grade S45C
Handle grips: Polypropylene
Length: 210mm.
Weight: 0.58kgs.



STAINLESS STEEL LADDER CABLE TIES

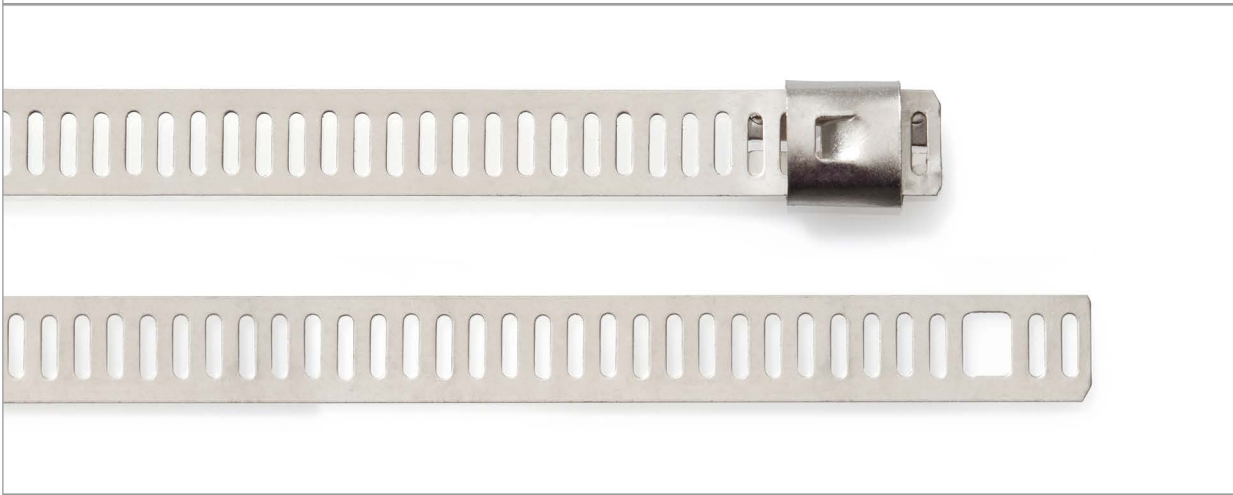

INFORMATION

- + Cable ties made from stainless steel AISI 316
- + Great for restraining harnesses and cables.
- + Quick and safe installation in a variety of applications.
- + Excellent resistance to acids, salt, chemicals, and high temperatures



PROPERTIES

Temperature range
-80°C to +500°C

Material
316 Stainless steel, Non toxic, recyclable.
Halogen free, flameproof, UV resistant.



File No
E475484



Items marked # are pending approval.



DIMENSIONS AND PACKAGING

TYPE	LENGTH (mm)	WIDTH (mm)	MAX BUNDLE DIAMETER (mm)	MIN. TENSILE STRENGTH (N)	PACKAGING
SSLT 2316	200	7.0	50	667	100
SSLT 3316	250	7.0	65	667	100
SSLT 3816	300	7.0	82	667	100
SSLT 4316	360	7.0	100	667	100
SSLT 4816	450	7.0	130	667	100





+ INFORMATION

- + Cable ties made from stainless steel AISI 316, coated with black polyester.
- + Quick and safe installation in a variety of applications.
- + The outer layer of polyester and gently rounded edges protect the cable from damage.
- + Excellent resistance to acids, salt, chemicals, and high temperatures.

+ PROPERTIES

Temperature range
-80°C to +150°C

Material
316 Stainless steel, with pure polyester coating
Non toxic, recyclable. Halogen free.



File No
E475484



Items marked # are pending approval.

+ DIMENSIONS AND PACKAGING

TYPE	LENGTH (mm)	WIDTH (mm)	MAX BUNDLE DIAMETER (mm)	MIN. TENSILE STRENGTH (N)	PACKAGING
SSLTC 2316	200	7.0	50	667	100
SSLTC 3316	250	7.0	65	667	100
SSLTC 3816	300	7.0	82	667	100
SSLTC 4316	360	7.0	100	667	100
SSLTC 4816	450	7.0	130	667	100

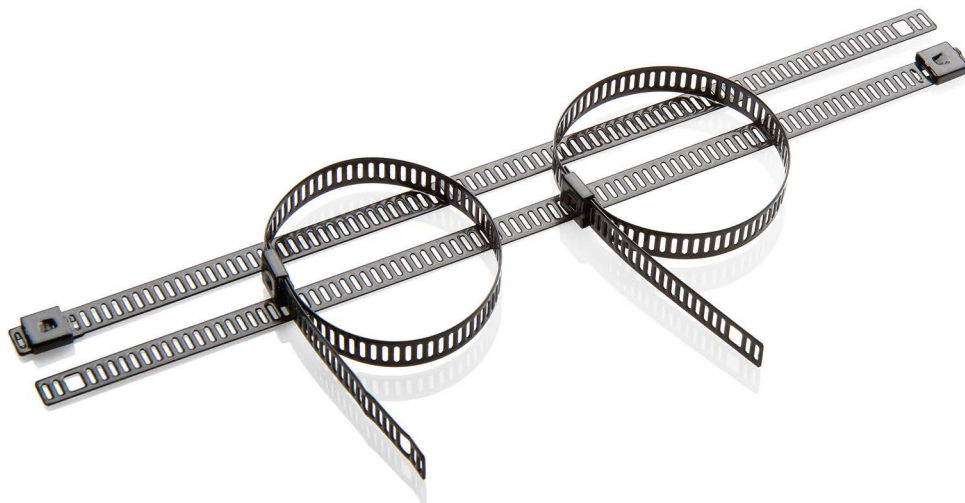

STAINLESS STEEL RELEASABLE CABLE TIES

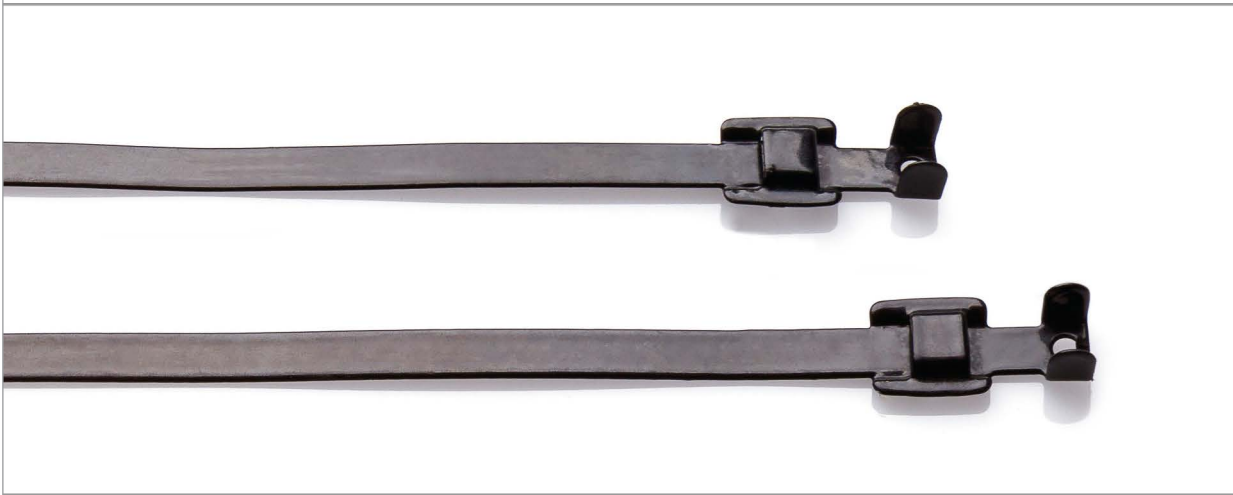

+ INFORMATION

- + Cable ties made from stainless steel AISI 316 coated with PPA.
- + Great for restraining harnesses and cables.
- + Quick and safe installation in a variety of applications.
- + Excellent resistance to acids, salt, chemicals, and high temperatures

+ PROPERTIES

Temperature range

-80°C to +500°C (stainless steel strap)
-60°C to +150°C (PPA coating)

Material

316 Stainless steel, Non toxic, recyclable. Halogen free, flameproof, UV resistant. PPA 571 is a flexible, tough and highly durable plastic coating which provides superior resistance to sun, salt and sea water, with excellent impact and abrasion resistance.



File No
E475484



Items marked # are pending approval.

+ DIMENSIONS AND PACKAGING

PPA coated

TYPE	LENGTH (mm)	WIDTH (mm)	MAX BUNDLE DIAMETER (mm)	MIN. TENSILE STRENGTH (N)	PACKAGING
RSST PPA100 #	100	6.35	18	1469	100
RSST PPA150	150	6.35	34	1469	100
RSST PPA229	229	6.35	59	1469	100
RSST PPA305	305	6.35	91	1469	100
RSST PPA457	457	6.35	129	1469	100
RSST PPA457HD	457	9.53	129	2000	100
RSST PPA610HD	610	9.53	177	2000	100



SCREW MOUNTABLE STAINLESS STEEL CABLE TIE SADDLES



INFORMATION

- + Designed to compliment our range of stainless steel cable ties
- + Single fixing hole, for ease of use
- + Robust and secure design
- + A cost effective solution for mounting cable ties



PROPERTIES

Working Temperature range

-80°C to +538°C

Packaging

Bags of 50

Material

316 Stainless Steel

Flammability

Non-flammable



DIMENSIONS

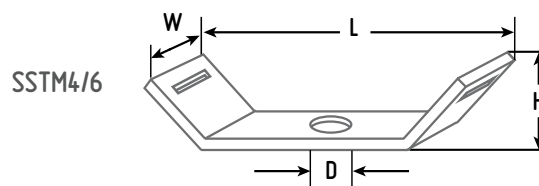

PART NUMBER	DIMENSIONS (mm)				HOLE	MAXIMUM TIE WIDTH
	LENGTH [L]	WIDTH [W]	HEIGHT [H]			
SSTM4	29.2	15.0	5.2		4.2	10.0
SSTM6	29.2	15.0	5.2		6.2	10.0



+ INFORMATION

- + To compliment our range of Stainless Steel cable ties, Partex has designed and manufactured a range of flameproof products.
- + These products have been developed to meet the general requirements of BS7671-2008 (2015) amendment 3 - chapter 52 regulation 521.11.201 which requires cabling to be supported by fire resistant fastenings and fixings.

+ PRODUCT RANGE



Stainless Steel Cable Tie Mount

- + A cost effective method for securing our stainless steel cable ties.
- + It is designed to accept both coated and un-coated ties up to 10mm wide.
- + The single fixing hole can accommodate a wide range of fixings.



Spacer Bar Saddles

- + Designed to upgrade existing UPVC conduit installations without the cost of rewiring by replacing the existing plastic saddles with steel.
- + The semi gloss powder coating matches the colour of white UPVC conduits, and can be secured using the existing fixing holes.



Mini-Trunking Cable Clips

- + These easy to install clips are designed to fit inside most designs of UPVC mini-trunking.
- + Once secured in place the raised tabs can be bent around the cables to retain them even if the trunking itself melts.



+ INFORMATION

- + Easy to install with a choice of fixing hole sizes.
- + Manufactured from corrosion resistant 316 Stainless Steel.
- + Can be used to secure pipework, conduits and bundles of cables.
- + Weather, fire and UV resistant, suitable for hazardous areas.

+ PROPERTIES

Temperature range
-80°C to +538°C

Packaging
Supplied in packs of 50

Material
316 Stainless Steel

Flammability
Non-flammable

+ DIMENSIONS

PART NUMBER	LENGTH [L]	DIMENSIONS (mm)			FIXING HOLE SIZE	MAXIMUM TIE WIDTH
		WIDTH [W]	HEIGHT [H]			
SSTM4	29.2	15.0	5.2	4.2	10.0	
SSTM6	29.2	15.0	5.2	6.2	10.0	

+ RELATED PRODUCTS



**STAINLESS STEEL
CABLE TIES**

▶ PAGE 26

SPACER BAR SADDLES



+ INFORMATION

- + Designed to replace existing UPVC conduit saddles.
- + Manufactured from powder coated galvanised steel.
- + Weather, UV, fire and corrosion resistant.
- + Suitable for indoor and outdoor use.

+ PROPERTIES

Material

Galvanised Steel

Flammability

non-flammable

Coating material

RAL9010 Semi-Gloss Polyester powder coat.

Packaging

Supplied in packs of 10

+ DIMENSIONS AND PACKAGING

PART NUMBER	LENGTH	DIMENSIONS (mm)		CONDUIT SIZE (mm)
		WIDTH	HEIGHT	
SBSW20	56	22	26	20
SBSW25	62	23	31	25



+ INFORMATION

- + Products available to suit a range of mini-trunking sizes
- + Manufactured from Galvanised Steel DX53.
- + Will reduce the risk of cables falling out of mini-trunking in the event of fire.
- + Weather, fire and UV resistant, suitable for hazardous areas.

+ PROPERTIES

Temperature range
-80°C to +412°C

Packaging
Supplied in packs of 50

Material
Galvanised Steel grade DX53

Flammability
Non-flammable

+ DIMENSIONS

PART NUMBER	LENGTH	DIMENSIONS (mm)		FIXING HOLE SIZE	TRUNKING TYPE
		WIDTH	HEIGHT		
MTCC-T2/6	19.0	15.0	22.5	6.2	T2 (25mm x 16mm)
MTCC-T3/6	28.5	15.0	32.5	6.2	T3 & T4 Suitable for 32mm to 40mm base. Folds to maximum height of 19mm.

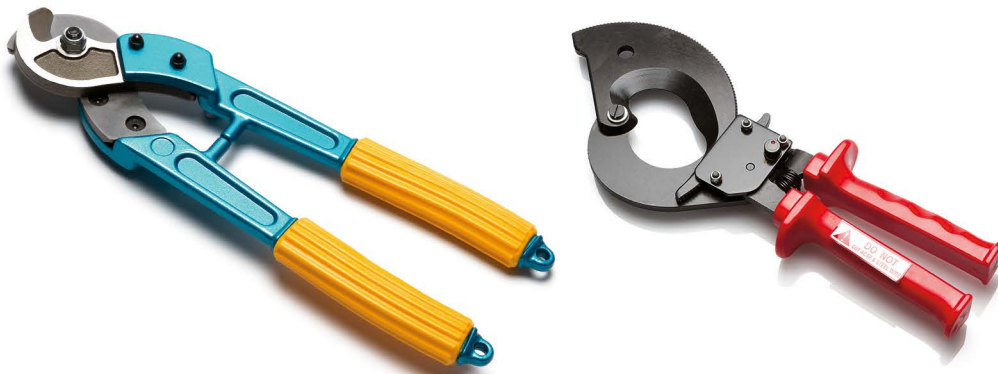

INFORMATION

- + An extensive range of cable cutting tools to suit any application.
- + Whatever your application, we should have a well designed and durable tool suited to the task.



PRODUCT RANGE



Wire and Cable Cutters

- + A range of low cost, precision cutting tools designed for cutting copper and aluminium wires and cables.
- + Ground precision blades offer greater durability, and the soft PVC handles reduce operator fatigue.
- + These tools are not suitable for cutting armoured cables.

▶ PAGE 43



Ratchet Cutters

- + An extensive range of ratchet operated cable cutters with high precision cast jaws, designed to cut smoothly and cleanly without distorting the cable.
- + The ratchet ensures consistent applied pressure, which reduces operator fatigue and enables single handed operation.
- + All of these tools has an emergency release lever which stops the cut cycle at any stage.
- + These tools are not suitable for cutting armoured cables.

▶ PAGE 45



Armoured Cable Cutters

- + These heavy duty tools have high carbon steel blades specifically designed for cutting through steel wire armoured cables, steel wires and bars.
- + They have soft grips and long heat treated aluminium handles for comfortable use.

▶ PAGE 47

+

WCS



- + Carbon steel hand held cutting tool, suitable for soft insulated copper and aluminium cables up to 10AWG or 5.26mm².

Specification:**Frame:** steel grade S45C.**Handles:** Soft PVC.**Length:** 130mm.**Width closed handles:** 65mm.**Weight:** 50g.

+

PCC38



- + Drop forged steel hand held cutting tool, suitable for stranded non-armoured copper and aluminium cables up to 38mm² with two cutting positions (10mm² and 38mm²).

Specification:**Body:** Drop forged high carbon steel.**Handle grips:** Soft PVC.**Length:** 210mm.**Weight:** 0.30kgs.**Maximum cutting diameter:** 12mm.

+

PCC80



- + Drop forged steel hand held cutting tool, suitable for stranded non-armoured copper and aluminium cables up to 80mm².
- + The precision ground blades ensure clean cutting without deforming the cable. Long handles reduce the required cutting force.

Specification:**Blades:** Drop forged high carbon steel.**Handles:** Heat treated Aluminium Alloy.**Handle grips:** Soft PVC.**Length:** 320mm.**Weight:** 0.73kgs.**Maximum cutting diameter:** 19mm.

+

PCC250



- + Light Weight hand held cutting tool, suitable for stranded non-armoured copper and aluminium cables up to 250mm².
- + The precision steel ground blades and extended aluminium handles ensure ease of operation and a long service life.

Specification:

Blades: Drop forged high carbon steel.

Handles: Heat treated Aluminium Alloy.

Handle grips: Soft PVC.

Length: 600mm.

Weight: 1.54kgs.

Maximum cutting diameter: 30mm.

+

PCC400A



- + Light Weight hand held cutting tool, suitable for stranded non-armoured copper and aluminium cables up to 400mm² (maximum diameter 32mm).
- + The precision steel ground blades and extended tubular aluminium alloy handles ensure ease of operation and a long service life.

Specification:

Blades: Drop forged high carbon steel.

Handles: Heat treated Aluminium Alloy.

Handle grips: Soft PVC.

Length: 700mm.

Weight: 1.57kgs.

Maximum cutting diameter: 32mm.

+

PRCC240



- + Ratchet controlled light weight and compact cable cutter, suitable for both copper and aluminium cables up to 240mm².
- + The ergonomic PVC handles ensure a firm and comfortable grip which reduces operator fatigue.

Specification:

Blade material: SAE4140

Frame material: SPCC SD2.5T

Handle grip material: PVC

Length: 255mm

Weight: 0.65kgs

Maximum cutting diameter: 30mm.

+

PRCC325



- + Ratchet controlled light weight and compact cable cutter, suitable for both copper and aluminium cables up to 325mm².
- + The moulded thermoplastic rubber handles ensure a firm and comfortable grip which reduces operator fatigue.

Specification:

Fixed blade material: Sk5 high carbon steel

Moving blade material: 63CRM hardened steel

Frame material: S45C

Handle grip material: Thermoplastic rubber

Length: 240mm

Weight: 0.60kgs

Maximum cutting diameter: 34mm.

+

PRCC380



- + Ratchet controlled light weight and compact cable cutter, suitable for both copper and aluminium cables up to 380mm².
- + The moulded polypropylene handles ensure a firm and comfortable grip which reduces operator fatigue.

Specification:

Blade material: SAE4340

Frame material: S45C

Handle grip material: PP

Length: 285mm

Weight: 0.85kgs

Maximum cutting diameter: 36mm.

RATCHET CABLE CUTTERS

+

PRCC400



- + Ratchet controlled light weight and compact cable cutter, suitable for both copper and aluminium cables up to 400mm².
- + The thermoplastic rubber handles ensure a firm and comfortable grip which reduces operator fatigue.

Specification:

Fixed blade material: Sk5 high carbon steel

Moving blade material: 63CRM hardened steel

Frame material: S45C

Handle grip material: Thermoplastic rubber

Length: 280mm.

Weight: 0.90kgs

Maximum cutting diameter: 38mm.

+

PRCC500



- + Ratchet controlled light weight and compact cable cutter, suitable for both copper and aluminium cables up to 500mm².
- + The moulded PVC handles ensure a firm and comfortable grip which reduces operator fatigue.

Specification:

Blade material: SAE4140

Frame material: SPCC SD2.5T

Handle grip material: PVC

Length: 276mm

Weight: 0.65kgs

Maximum cutting diameter: 45mm.

+

PRTC500



- + Ratchet controlled light weight and compact cable cutter, specifically designed for cutting telephone cables up to 2700 pairs.
- + The moulded polypropylene handles ensure a firm and comfortable grip which reduces operator fatigue.

Specification:

Blade material: SAE4340

Frame material: S45C

Handle grip material: PP

Length: 345mm

Weight: 1.3kgs

Maximum cutting diameter: 70mm.



PCC-SW100



- + Heavy duty cable cutter for cutting of steel wire armoured aluminium & copper cables. Precision steel ground blades ensure a clean straight cut without cable distortion and a long service life. The PVC cushioned aluminium alloy handles ensure an optimal grip and reduce operator fatigue.
- + Cutting capacity:
 - copper and aluminium cables up to 95mm²
 - Wire rope up to 10mm diameter.
 - Steel bar up to 7mm diameter.

Specification:

Blades: 63 CRM high carbon steel

Handles: Heat treated Aluminium Alloy

Handle grips: Soft PVC

Length: 445mm

Weight: 1.1kgs



PCC-SW150



- + Heavy duty cable cutter for cutting of steel wire armoured aluminium & copper cables. Precision steel ground blades ensure a clean straight cut without cable distortion and a long service life. The PVC cushioned aluminium alloy handles ensure an optimal grip and reduce operator fatigue.
- + Cutting capacity:
 - copper and aluminium cables up to 150mm²
 - Wire rope up to 14mm diameter.
 - Steel bar up to 9mm diameter.

Specification:

Blades: 63 CRM high carbon steel

Handles: Heat treated Aluminium Alloy

Handle grips: Soft PVC

Length: 600mm

Weight: 2.1kgs

CABLE STRIPPERS



INFORMATION

- + An extensive range of cable stripping tools to suit any application.
- + Whatever your application, we should have a well designed and durable tool suited to the task.



PRODUCT RANGE



CCS1 - Co-axial Cable Stripper

- + An economical high performance co-axial cable stripper with strong ergonomic design.
- + It performs three level stripping of coaxial cables, the outer sheath, woven braid and inner dielectric insulator simultaneously.
- + For use with: Coaxial cables, 3C2V & 5C2V, RG/U6, RG58, RG59, RG62.

Specification:

Body: ABS.

Blades: Steel SK5.

Length: 110mm



RCS1 - Rotary Cable Stripper

- + Designed as a safe and easy to use tool for removing the PVC or rubber insulation from round cables between 4mm and 25mm in diameter.
- + The depth of cut is fully adjustable, and can remove insulation from either the end of a cable or mid-span.

Specification:

Retention arm: Steel SPCC-SD/2.5T

Housing: Polypropylene +15% glass fibre

Cylinder: Steel SAE1215

Blade: Steel SK-4

Length: 140mm

+

PWS-A



- + Hand held semi automatic cable stripper for stripping soft insulated cables from 24 to 14 AWG, 0.25mm² to 2.5mm².
- + Strips and removes insulation in one operation.

Specification:**Frame body:** Zinc alloy.**Blade:** Steel S50C.**Grip jaw:** Steel S45C.**Handle grip:** PVC coated.

+

PWS-B



- + Hand held semi automatic cable stripper for stripping soft insulated cables from 20 to 10 AWG, 0.50mm² to 6.0mm².
- + Strips and removes insulation in one operation.

Specification:**Frame body:** Zinc alloy.**Blade:** Steel S50C.**Grip jaw:** Steel S45C.**Handle grip:** PVC coated.

+

PWS-GUN1



- + A hand held semi automatic cable cutter and stripper for soft insulated cables from 24 to 10 AWG, 0.2mm² to 6mm².
- + The stripping depth and length are fully adjustable.

Specification:**Moving body:** ABS**Fixed body:** Steel SS41.**Cutting jaws:** S50C Steel.**Length:** 170mm.**Weight:** 230g

+

PWS-GUN2



- + A lightweight hand held semi automatic cable stripper for soft insulated cables from 0.75mm² to 16mm². It strips and removes the insulation in one operation.
- + The stripping blade self adjusts to suit the cable.

Specification:**Body:** ABS**Cutting blades:** SK5 steel**Cutter blade holders:** Aluminium Alloy 6061**Length:** 180mm**Weight:** 200g



+ INFORMATION

- + An extensive selection of cable crimping tools to compliment our range of terminals and connectors.
- + We also offer a range of ergonomic tools to further reduce operator fatigue.
- + Most of these tools can be supplied with a calibration certificate if required

For more information on our in-house Calibration and Repair service, see [▶ PAGE 63](#)

+ PRODUCT RANGE



Terminal Crimpers

- + From a simple hand tool through to a fully calibrated ratchet crimper, we can offer a wide range of high quality tools to suit your needs.
- + The ratchet tools release automatically once the required amount of force has been applied to the terminal.
- + The soft plastic handles reduce fatigue and the hard wearing steel jaws offer great durability.

[▶ PAGE 51](#)



Copper Tube Crimpers

- + From a basic manual hand tool, to a high pressure hydraulic tool, we can offer several solutions to meet your needs.
- + They are specifically designed to work perfectly with our COL range of copper tube terminals.

[▶ PAGE 54](#)



Cord End Ferrule/Bootlace Crimpers

- + A full selection of high quality ratchet crimpers to compliment our range of cord-end ferrules/bootlaces. Each tool has removable jaws which can be replaced when worn out, to extend the life of the tool.

[▶ PAGE 59](#)



Solar Connector Crimper

- + A robust and easy to use tool, for use with MC3 and MC4 solar cable crimp connectors

[▶ PAGE 53](#)

+ CT1



- + Hand held manual operated economy crimping and stripping tool for standard pre-insulated red, blue & yellow terminals.
- + Built in bolt cutter for thread sizes, M2.6, M3, M3.5, M4 and M5, stripper for cable sizes 0.75, 1.0, 1.5, 2.5, 4.0, and 6.0mm².

Specification:

Frame: steel grade S45C.

Handles: Polypropylene

Length: 218mm

+ CT15



- + Our most popular hand held triple jaw crimping tool, with ratchet mechanism for complete controlled crimp cycle, for use with standard pre-insulated red, blue & yellow terminals from 0.5mm up to 6mm².
- + Meets the compression ratio requirements of BSEN 60352-2:2006 and BS 5G178:1992.
- + The high precision jaws can be replaced when worn to extend the life of the tool.

Specification:

Jaw set: Carbon steel grade SCM440

Frame: Material steel grade S45C

Handles: Polypropylene

Length: 225mm

Weight: 0.55kg

To order this tool with a calibration certificate use catalogue number: **CT15CAL**

+ ECT15



- + Ergonomic hand held triple jaw crimping tool, with ratchet mechanism for complete controlled crimp cycle, for use with standard pre-insulated red, blue & yellow terminals from 0.5mm up to 6mm².
- + The longer, moulded handles reduce the amount of force needed to operate the tool.
- + Meets the compression ratio requirements of BSEN 60352-2:2006 and BS 5G178:1992.
- + The high precision jaws can be replaced when worn to extend the life of the tool.

Specification:

Jaw set: carbon steel grade SCM440.

Frame: material steel grade S45C.

Handles: Polypropylene

Length: 248mm

Weight: 0.65kg

To order this tool with a calibration certificate use catalogue number: **ECT15CAL**

+

UCT15



- + A hand held triple jaw crimping tool, with ratchet mechanism for complete controlled crimp cycle, for use with standard non-insulated terminals from 0.5mm up to 6mm².
- + Meets the compression ratio requirements of BSEN 60352-2:2006 and BS 5G178:1992.
- + The high precision jaws can be replaced when worn to extend the life of the tool.

Specification:

Jaw set: Carbon steel grade SCM440

Frame: Material steel grade S45C

Handles: Polypropylene

Length: 225 mm

Weight: 0.55kg

To order this tool with a calibration certificate use catalogue number: **UCT15CAL**

+

EUCT15



- + Ergonomic hand held triple jaw crimping tool, with ratchet mechanism for complete controlled crimp cycle, for use with standard non-insulated terminals from 0.5mm up to 6mm².
- + The longer, moulded handles reduce the amount of force needed to operate the tool.
- + Meets the compression ratio requirements of BSEN 60352-2:2006 and BS 5G178:1992.
- + The high precision jaws can be replaced when worn to extend the life of the tool.

Specification:

Jaw set: carbon steel grade SCM440.

Frame: material steel grade S45C.

Handles: Polypropylene

Length: 248mm

Weight: 0.65kg

To order this tool with a calibration certificate use catalogue number: **EUCT15CAL**



+ CT FLAG

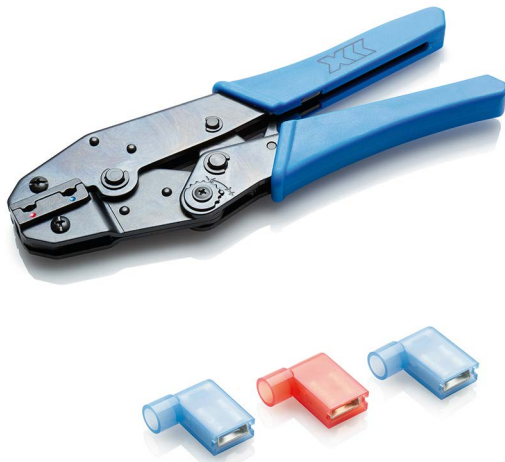

- + A hand held crimping tool, with ratchet mechanism for complete controlled crimp cycle, for use with nylon insulated red and blue Flag Terminals from 0.5mm up to 2.5mm².
- + Meets the compression ratio requirements of BSEN 60352-2:2006 and BS 5G178:1992.
- + The high precision jaws can be replaced when worn to extend the life of the tool.

Specification:

Jaw set: Carbon steel grade SCM440

Frame: Material steel grade S45C

Handles: Polypropylene

Length: 225mm

Weight: 0.55kg

To order this tool with a calibration certificate use catalogue number: **CT FLAGCAL**

+ CT-HSB



- + A hand held triple jaw crimping tool, with ratchet mechanism for complete controlled crimp cycle, for use with red, blue and yellow Heat-Shrink Butt connectors from 0.5mm up to 6.0mm².
- + Meets the compression ratio requirements of BSEN 60352-2:2006 and BS 5G178:1992.
- + The high precision jaws can be replaced when worn to extend the life of the tool.

Specification:

Jaw set: Carbon steel grade SCM440

Frame: Material steel grade S45C

Handles: Polypropylene

Length: 225mm

Weight: 0.55kg

To order this tool with a calibration certificate use catalogue number: **CT-HSBICAL**

+ CT-MC4



- + A hand held triple jaw crimping tool, with ratchet mechanism for complete controlled crimp cycle, for use MC3 and MC4 solar connectors 2.5 to 6mm².
- + Meets the compression ratio requirements of BSEN 60352-2:2006 and BS 5G178:1992.
- + The high precision jaws can be replaced when worn to extend the life of the tool.

Specification:

Jaw set: Carbon steel grade SCM440

Frame: Material steel grade S45C

Handles: Polypropylene

Length: 225mm

Weight: 0.55kg

To order this tool with a calibration certificate use catalogue number: **CT-MC4CAL**

COPPER TUBE TERMINAL CRIMPERS

+

CT1.5-16



1.5mm² to 16mm²



- + A hand held four jaw crimping tool, with ratchet mechanism for complete controlled crimp cycle, for use with standard copper tube terminals from 1.5mm up to 16mm².
- + Meets the compression ratio requirements of BSEN 60352-2:2006, BSEN61238-1:2003 and BS 5G178:1992.
- + The high precision jaws can be replaced when worn to extend the life of the tool.

Specification:

Jaw set: carbon steel grade SCM440.

Frame: material steel grade S45C.

Handles: Polypropylene

Length: 225mm

Weight: 0.55kg

To order this tool with a calibration certificate use catalogue number: **CT1.5-16CAL**

+

CT10-16



10mm² to 16mm²



- + Precision hand held two jaw crimping tool, with ratchet mechanism for complete controlled crimp cycle, for use with seamed AWG and H/D 10mm² and 16mm² copper tube terminals.
- + Meets the compression ratio requirements of BSEN61238-1:2003.

Specification:

Jaw set: carbon steel grade SCM440.

Frame: material steel grade S45C.

Handles: Polypropylene

Length: 248mm

Weight: 0.60kg

To order this tool with a calibration certificate use catalogue number: **CT10-16CAL**

+

CT6-25



6mm² to 25mm²



- + Precision hand held four jaw crimping tool, with ratchet mechanism for complete controlled crimp cycle, for use with seamed AWG and H/D copper tube terminals from 6mm² up to 25mm².
- + Meets the compression ratio requirements of BSEN 60352-2:2006 and BSEN 61238-1:2003.

Specification:

Jaw set: carbon steel grade SCM440.

Frame: material steel grade S45C.

Handles: Polypropylene

Length: 360mm

Weight: 0.90kg

+

CT50



- + A hand held crimping tool, with rotatable dies for easy selection.
- + For crimping seamed AWG and H/D copper tube terminals from 6mm² up to 50mm².
- + Hexagonal die form.
- + Long tubular handles with soft grips for reduced effort and fatigue.
- + Meets the compression ratio requirements of BSEN60352-2:2006 and BSEN61238-1:2003.

Specification:

Die and Head: Carbon steel grade SCM440

Handles: Tubular steel

Handle grips: Polypropylene

Length: 225mm

Weight: 1.3kg

+

CT10-95i



- + A hand held indent crimping tool, for use with COL and PXL copper tube terminals from 10mm² up to 95mm².
- + Manual screw adjustment for easy die selection.
- + Meets the compression ratio requirements of BSEN 61238-1:2003.

Specification:

Jaw set: Carbon steel grade SCM440

Frame: Nodular cast iron

Handles: PVC

Length: 570mm

Weight: 2.9kg

To order this tool with a calibration certificate use catalogue number: **CT10-95iCAL**

+

CT120i



- + A hand held indent crimping tool, for use with COL and PXL copper tube terminals from 16mm² up to 120mm².
- + Manual screw adjustment for easy die selection.
- + Meets the compression ratio requirements of BSEN 61238-1:2003.
- + Tubular steel handles to reduce weight.

Specification:

Jaw set: Carbon steel grade SCM440

Handles: Tubular steel

Handle grips: PVC

Length: 645mm

Weight: 3.5kg

To order this tool with a calibration certificate use catalogue number: **CT120iCAL**

+

CT120



10mm² to 120mm²

- + A hand held crimping tool, with rotatable dies for easy selection.
- + For crimping seamed AWG and H/D copper tube terminals from 10mm² up to 120mm².
- + Hexagonal die form.
- + Long tubular handles with soft grips for reduced effort and fatigue.
- + Meets the compression ratio requirements of BSEN61238-1:2003.

Specification:

Die and Head: Carbon steel grade SCM440

Handles: Tubular steel

Handle grips: Soft PVC

Length: 637mm

Weight: 4.0kg

+

CT150



25mm² to 150mm²

- + A hand held crimping tool, with rotatable dies for easy selection.
- + For crimping seamed AWG and H/D copper tube terminals from 25mm² up to 150mm².
- + Hexagonal die form.
- + Long tubular handles with soft grips for reduced effort and fatigue.
- + Meets the compression ratio requirements of BSEN61238-1:2003.

Specification:

Die and Head: Carbon steel grade SCM440

Handles: Tubular steel

Handle grips: Soft PVC

Length: 637mm

Weight: 4.0kg





+ INFORMATION

- + Hydraulic crimp tool to suit copper cable terminals from 10mm² up to 240mm².
- + Supplied in a robust, impact resistant plastic case.
- + Complete with a full set of removable dies.
- + Meets the compression ratio requirements of BSEN 61238-1:2003.

+ SPECIFICATION

Maximum pressure
550 Bar

Length
375 mm

Oil capacity
56CC

Weight
2.8kgs

Max output
5.2 Tonnes

+ PHCT-24OKIT



10mm² to 240mm²



- + A hand held hydraulic crimping tool, for use with copper tube terminals from 10mm² up to 240mm².
- + The two stage hydraulic system ensures rapid advance on low pressure, minimising the number of pump cycles needed to achieve maximum compression.
- + The kit contains seven interchangeable hexagon die sets: 10/16mm², 25/35mm², 50/70mm², 95/120mm², 150mm², 185mm² and 240mm².
- + Please specify the required Die Set when ordering.
Option 1: PHCT-24OKIT-COL
Supplied with dies suitable for crimping our COL range of terminals. (see page 79)
Option 2: PHCT-24OKIT-HD
Supplied with dies suitable for heavy duty terminals.
- + The crimp head can rotate 180° for ease of use.
- + Meets the compression ratio requirements of BSEN 61238-1:2003.

To order either of these tools with a calibration certificate please add /CAL to the end of the part number: For example **PHCT-24OKIT-COL/CAL**

HYDRAULIC COPPER TUBE TERMINAL CRIMPERS



+ INFORMATION

- + Hydraulic crimp tool to suit copper cable terminals from 16mm² up to 400mm².
- + Supplied in a robust, impact resistant plastic case.
- + Complete with a full set of removable dies.
- + Meets the compression ratio requirements of BSEN 61238-1:2003.

+ SPECIFICATION

Maximum pressure
700bar

Length
612mm

Oil capacity
14.7CC

Weight
6.5kgs

Max output
11.6 Tonnes

+ PHCT-400KIT



16mm² to 400mm²



- + A hand held hydraulic crimping tool, for use with copper tube terminals from 16mm² up to 400mm².
- + The two stage hydraulic system ensures rapid advance on low pressure, minimising the number of pump cycles needed to achieve maximum compression.
- + The kit contains twelve interchangeable hexagon die sets from 16mm² up to 400mm².
- + Please specify the required Die Set when ordering.
Option 1: PHCT-400KIT-COL
Supplied with dies suitable for crimping our COL range of terminals. (see page 79)
Option 2: PHCT-400KIT-HD
Supplied with dies suitable for heavy duty terminals.
- + The crimp head can rotate 180° for ease of use.
- + Meets the compression ratio requirements of BSEN 61238-1:2003.

To order either of these tools with a calibration certificate please add /CAL to the end of the part number: For example **PHCT-400KIT-COL/CAL**

+ CEFT01



0.14mm² to 2.5mm²



- + A hand held seven jaw crimping tool, with ratchet mechanism for complete controlled crimp cycle. For use with standard cord end ferrules/bootlaces from 0.14mm² up to 2.5mm², to DIN standard 46228 pt 1 & 4.
- + Meets the compression ratio requirements of BSEN 60998 and BSEN 60999.

Specification:

Jaw set: Carbon steel grade SCM440

Frame: Steel grade S45C

Handles: Polypropylene

Length: 203mm

Weight: 0.39kg

To order this tool with a calibration certificate use catalogue number: **CEFT01CAL**

+ CEFT1



0.5mm² to 6mm²



- + A hand held five jaw crimping tool, with ratchet mechanism for complete controlled crimp cycle. For use with standard cord end ferrules/bootlaces from 0.5mm² up to 6.0mm², to DIN standard 46228 pt 1 & 4.
- + Meets the compression ratio requirements of BSEN 60998 and BSEN 60999.

Specification:

Jaw set: Carbon steel grade SCM440

Frame: Steel grade S45C

Handles: Polypropylene

Length: 203mm

weight: 0.39kg

To order this tool with a calibration certificate use catalogue number: **CEFT1CAL**

+ ECEFT4



0.5mm² to 10mm²



- + An ergonomic hand held six jaw crimping tool, with ratchet mechanism for complete controlled crimp cycle. For use with standard cord end ferrules/ bootlaces from 0.5mm² up to 10.0mm², to DIN standard 46228 pt 1 & 4.
- + Meets the compression ratio requirements of BSEN 60998 and BSEN 60999.

Specification:

Jaw set: Carbon steel grade SCM440

Frame: Steel grade S45C

Handles: Polypropylene

Length: 248mm

Weight: 0.65kg

To order this tool with a calibration certificate use catalogue number: **ECEFT4CAL**

CORD END FERRULE/BOOTLACE CRIMPERS

+

CEFT2



6mm² to 16mm²



- + A hand held three jaw crimping tool, with ratchet mechanism for complete controlled crimp cycle. For use with standard cord end ferrules/bootlaces from 6.0mm² up to 16.0mm², to DIN standard 46228 pt 1 & 4.
- + Meets the compression ratio requirements of BSEN 60998 and BSEN 60999.

Specification:

Jaw set: Carbon steel grade SCM440

Frame: Steel grade S45C

Handles: Polypropylene

Length: 203mm

Weight: 0.39kg

To order this tool with a calibration certificate use catalogue number: **CEFT2CAL**

+

CEFT3



16mm² to 35mm²



- + A hand held three jaw crimping tool, with ratchet mechanism for complete controlled crimp cycle. For use with standard cord end ferrules/bootlaces from 16mm² up to 35mm², to DIN standard 46228 pt 1 & 4.
- + Meets the compression ratio requirements of BSEN 60998 and BSEN 60999.

Specification:

Jaw set: Carbon steel grade SCM440

Frame: Steel grade S45C

Handles: Polypropylene

Length: 222mm

Weight: 0.54kg

To order this tool with a calibration certificate use catalogue number: **CEFT3CAL**

+

ECEFT5



16mm² to 35mm²



- + An ergonomic hand held three jaw crimping tool, with ratchet mechanism for complete controlled crimp cycle. For use with standard cord end ferrules/bootlaces from 16mm² up to 35mm², to DIN standard 46228 pt 1 & 4.
- + Meets the compression ratio requirements of BSEN 60998 and BSEN 60999.

Specification:

Jaw set: Carbon steel grade SCM440

Frame: Steel grade S45C

Handles: Polypropylene

Length: 248mm

Weight: 0.65kg

To order this tool with a calibration certificate use catalogue number: **ECEFT5CAL**



50mm² to 95mm²



- + A hand held three jaw crimping tool, with ratchet mechanism for complete controlled crimp cycle. For use with standard cord end ferrules/bootlaces from 50mm² up to 95mm², to DIN standard 46228 pt 1 & 4.
- + Meets the compression ratio requirements of BSEN 60998 and BSEN 60999.

Specification:

Head: Cast steel
Frame: Steel grade S45C
Handles: Soft PVC
Length: 330mm
Weight: 0.78kg

To order this tool with a calibration certificate use catalogue number: **CEFT6CAL**



0.5mm² to 6mm²



- + A hand held seven jaw crimping tool, with ratchet mechanism for complete controlled crimp cycle. For use with twin entry cord end ferrules/bootlaces from 0.5mm² up to 6.0mm², to DIN standard 46228 pt 1 & 4.
- + Meets the compression ratio requirements of BSEN 60998 and BSEN 60999.

Specification:

Jaw set: Carbon steel grade SCM440
Frame: Steel grade S45C
Handles: Polypropylene
Length: 230mm
Weight: 0.6kg

To order this tool with a calibration certificate use catalogue number: **TCEFT1CAL**



HOT AIR GUN



INFORMATION

- + Suitable for continuous commercial use
- + Ergonomic design with well balanced soft grip handles
- + Electronic motor with over heat protection, and two heat settings
- + Supplied complete with an accessory/nozzle pack
- + Robust impact resistant body allows the tool to operate in a freestanding upright position



PROPERTIES

Power

220 - 240V 50Hz 1800W
Fitted with a fused 13amp UK plug
2 metre heat resisting mains lead
Certified with CE mark

Dimensions

240mm x 200mm x 85mm

Weight

0.75Kg



Output

Setting 1: 400°C, 250 litres/minute
Setting 2: 600°C, 500 litres/minute



ORDERING INFORMATION

- + HG2-KIT Hot air gun complete with set of nozzle attachments and a steel scraper



RELATED PRODUCTS



HEAT-SHRINK

▶ PAGE 100



HEAT-SHRINK KITS

▶ PAGE 102



INFORMATION

- + Cost effective service with very fast turnaround
- + Hand operated, heavy duty or hydraulic tools can be calibrated and repaired in-house by Partex
- + An on-site service can also be arranged if required
- + Certification can be provided to all relevant BS/EN standards
- + New tools can be ordered complete with calibration certificates if required



CALIBRATION

Should crimp tools be calibrated?

At Partex, we believe the answer is **YES**.

In order to ensure that crimp tools are operating correctly, many specifiers now insist that they are regularly tested and certified.

- + We recommend that tools should be calibrated at least once a year, and more frequently depending upon usage and application.
- + The purpose of any crimp tool is to attach a connector to the end of a cable, enabling the cable to be safely terminated.
- + For a perfect crimp connection to be made, the correct amount of force must be applied to the connector.
 - If this force is too great, the conductor or connector may become damaged or even cracked, leading to an unsafe termination.
 - Too little force may result in the connector falling off the conductor, or in a poor and possibly dangerous electrical connection.
- + By performing test crimps and submitting them to pull-off tests, or by measuring the distance between the fixed and moving crimp dies of the tools, we are able to adjust them to ensure that each crimp will be applied with the optimum force.
- + Depending upon the industry sector, there are several test standards that apply to cable terminations.
- + We are able to calibrate and certify to any of these standards, including the following:
 - BS EN 60352-1:2006**
 - BS EN 61238-1:2003**
 - BS EN 60999-1:2000**
 - BS EN 60998-2:2004**
- + For more information, please contact our Calibration and Repair Department.
 Email: calibration@partex.co.uk
 Telephone: 01675 463670

CRIMP TERMINALS



+ INFORMATION

- + A comprehensive range of pre-insulated and un-insulated Crimp Terminals.
- + Manufactured from tin coated high conductivity copper and brass.
- + High grade PVC insulation ensures complete integrity of the termination.
- + Meet the requirements of BS EN and international standards.

+ PROPERTIES

Temperature range

-20°C to +75°C

Insulation Material

PVC

Specification

Red insulation: Conductor size 0.5 - 1.5mm² / 22-16 awg

Blue insulation: Conductor size 1.5 - 2.5mm² / 16-14 awg

Yellow insulation: Conductor size 4.0 - 6.0mm² / 12-10 awg

Standard Terminals

Maximum Voltage: 600 Volt

UL Approval numbers: E482299/E482300

Terminal Material: C1100 Copper

Approvals

UL File number E482299/E482300.

Packaging

Supplied in bags of 100

Tabs and Receptacles:

Maximum Voltage: 300 Volt

UL Approval numbers: E482299/E482300

Terminal Material: C2680 Brass



VR indicates 'Vibration Resistant' - Extra copper ring within the crimp terminal.

+ RELATED PRODUCTS



CRIMPING TOOLS

▶ PAGE 50



CRIMPER KITS

▶ PAGE 72

+ RING TERMINALS

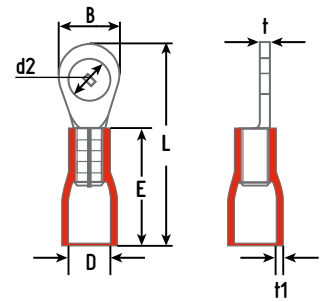

CAT NO	d2	B	L	DIMENSIONS (mm)				INSULATION COLOUR
				D	E	t	t1	
RR32	3.20	5.50	17.50					
RR37	3.70	5.50	17.50					
RR43	4.30	8.00	21.70					
RR53	5.30	8.00	21.70	4.30	10.50	0.75	0.80	RED
RR64	6.40	11.60	27.60					
RR84	8.40	11.60	27.60					
RR105	10.50	13.70	31.50					
BR32	3.20	8.50	23.00					
BR37	3.70	6.60	20.60					
BR43	4.30	8.50	23.00					
BR53	5.30	9.50	23.00	4.70	11.00	0.80	0.80	BLUE
BR64	6.40	12.00	28.10					
BR84	8.40	12.00	28.10					
BR105	10.50	13.70	31.90					
BR120	13.00	19.00	35.50					
YR43	4.30	9.50	26.70					
YR53	5.30	9.50	26.70					
YR64	6.40	12.00	32.70	6.70	14.00	1.00	0.80	YELLOW
YR84	8.40	15.00	34.90					
YR105	10.50	15.00	34.90					
YR120	13.00	19.20	39.60					



PRE-INSULATED CRIMP TERMINALS

+ FORK/SPADE TERMINALS

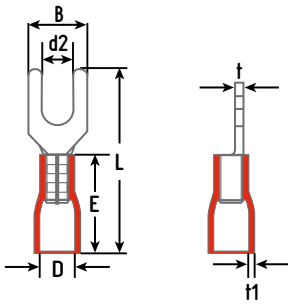

CAT NO	DIMENSIONS (mm)							INSULATION COLOUR
	d2	B	L	D	E	t	t1	
RS32N	3.20	5.70	22.00					
RS37	3.70	6.20	22.00					
RS37N	3.70	5.70	22.00					
RS43	4.30	7.20	22.00	4.30	10.50	0.75	0.80	RED
RS43N	4.30	6.40	22.00					
RS53	5.30	8.00	22.00					
RS64	6.40	10.70	23.00					
BS32N	3.20	5.70	22.50					
BS37	3.70	6.20	22.50					
BS37N	3.70	5.70	22.50					
BS43	4.30	7.20	22.50	4.70	11.00	0.80	0.80	BLUE
BS43N	4.30	6.40	22.50					
BS53	5.30	8.00	22.50					
BS64	6.40	10.70	23.50					
YS37	3.70	8.10	26.70					
YS43	4.30	8.20	26.70					
YS53	5.30	9.00	26.70	6.70	14.00	1.00	0.80	YELLOW
YS64	6.40	12.00	30.70					
YS84	8.40	13.50	32.60					

+ BUTT CONNECTORS

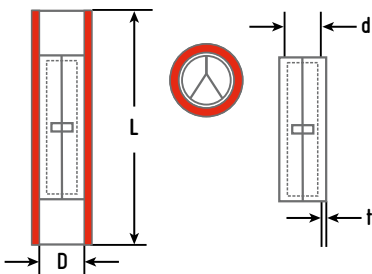

CAT NO	DIMENSIONS (mm)				INSULATION COLOUR
	d	D	L	t	
RBC4	1.70	4.30	25.00	0.75	RED
BBC45	2.30	4.50	25.00	0.80	BLUE
YBC68	3.40	6.50	27.00	1.00	YELLOW

+ MALE BULLET

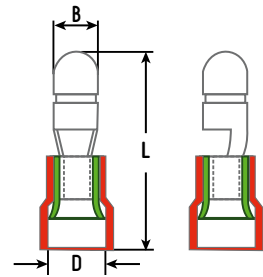

CAT NO	DIMENSIONS (mm)			INSULATION COLOUR
	D	B	L	
RMB40/VR	4.10	4.00	21.50	RED
BMB50/VR	4.90	5.00	22.50	BLUE
YMB50/VR	6.50	5.00	26.00	YELLOW

+ FEMALE BULLETS

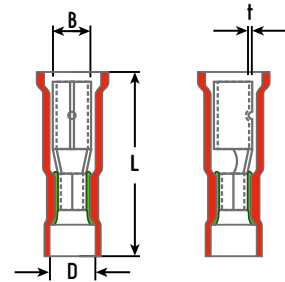

CAT NO	DIMENSIONS (mm)				INSULATION COLOUR
	D	B	L	t	
RFB40/VR	4.30	4.65	24.50		RED
BFB50/VR	4.90	5.65	24.50	0.40	BLUE
YFB50/VR	6.50	5.65	28.00		YELLOW

+ PIN TERMINALS

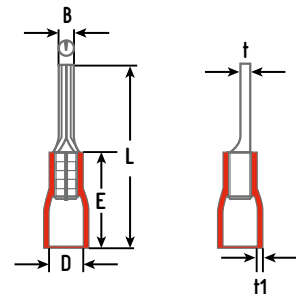

CAT NO	DIMENSIONS (mm)						INSULATION COLOUR
	B	L	D	E	t	n1	
RP10	2.00	22.50	4.30	10.50	0.75	0.80	RED
BP10	2.00	23.00	4.70	11.00	0.80	0.80	BLUE
YP14	2.70	27.50	6.70	14.00	1.00	0.80	YELLOW

PRE-INSULATED CRIMP TERMINALS

+ BLADE TERMINALS

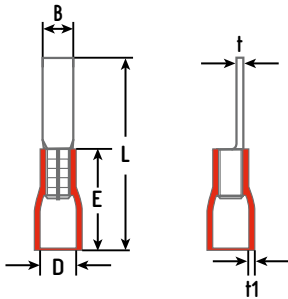

CAT NO	DIMENSIONS (mm)						INSULATION COLOUR
	B	L	D	E	t	t1	
RB11	3.00	21.50					
RB14	3.00	25.00	4.30	10.50	0.75	0.80	RED
RB18	2.45	28.50					
BB9	2.80	20.00					
BB18	2.45	29.00	4.70	11.00	0.80	0.80	BLUE
YB10	2.80	24.00					
YB18	2.80	32.00	6.70	14.00	1.00	0.80	YELLOW

+ HOOK BLADE TERMINALS

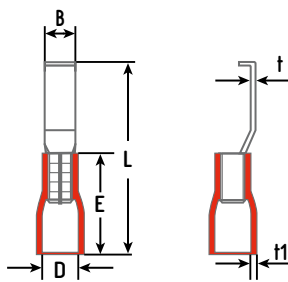

CAT NO	DIMENSIONS (mm)						INSULATION COLOUR
	B	L	D	E	t	t1	
RHBL3.0	2.80	28.50	4.30	10.50	0.80	0.80	RED
RHBL4.6	4.60	28.50					
BHBL3.0	2.80	28.50	4.70	11.00	0.80	0.80	BLUE
BHBL4.6	4.60	28.50					
YHBL3.0	2.80	31.80	6.70	14.00	1.00	0.80	YELLOW

+ FLANGED FORK/SPADE

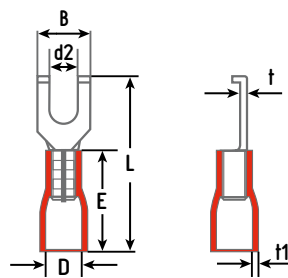

CAT NO	DIMENSIONS (mm)							INSULATION COLOUR
	d2	B	L	D	E	t	t1	
RFS43	4.30	7.20	22.00	4.30	10.50	0.75	0.80	RED
BFS43	4.30	7.20	22.50	4.70	11.00	0.80	0.80	BLUE
BFS43	5.30	8.00	25.50	6.70	14.00	0.80	0.80	YELLOW

+ MALE TAB TERMINAL

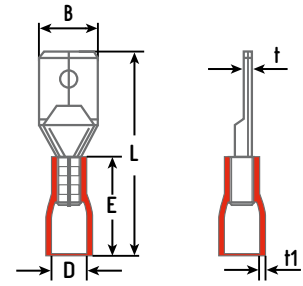

CAT NO	DIMENSIONS (mm)						INSULATION COLOUR
	D	B	L	E	t	t1	
RM50/VR	4.10	4.80	22.00	10.50			RED
RM63/VR	4.10	6.40	22.00	10.50			RED
BM50/VR	4.90	4.80	22.50	11.00	0.80	0.80	BLUE
BM63/VR	4.90	6.40	22.50	11.00			BLUE
YM63/VR	6.50	6.40	24.50	14.00			YELLOW

+ FEMALE PUSH ON

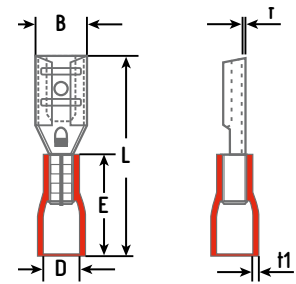

CAT NO	TO SUIT TAB		DIMENSIONS (mm)				t	t1	INSULATION COLOUR
	WIDTH	THICKNESS	D	B	L	E			
RF32/05/VR	2.80	0.50	4.10	3.20	19.00	10.50	0.50		RED
RF32/08/VR	2.80	0.80	4.10	3.20	19.00	10.50			
RF50/05/VR	4.80	0.50	4.10	5.00	19.50	10.50			
RF50/08/VR	4.80	0.80	4.10	5.00	19.50	10.50	0.80	0.80	BLUE
RF66/08/VR	6.40	0.80	4.10	6.70	21.50	10.50			
BF50/05/VR	4.80	0.50	4.90	5.00	20.00	11.00			
BF50/08/VR	4.80	0.80	4.90	5.00	20.00	11.00	1.00		YELLOW
BF66/08/VR	6.40	0.80	4.90	6.70	22.00	11.00			
BF80/08/VR	8.20	0.80	4.90	8.50	24.50	11.00			
YF66/08/VR	6.40	0.80	6.50	6.70	25.00	14.00	1.00		YELLOW
YF100/08/VR	9.40	1.20	6.50	9.90	30.10	14.00			

PRE-INSULATED CRIMP TERMINALS

+ FULLY INSULATED PUSH ON

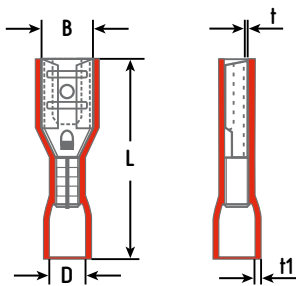

CAT NO	TO SUIT TAB		DIMENSIONS (mm)					INSULATION COLOUR
	WIDTH	THICKNESS	D	B	L	t	t1	
RF32/FI/VR	2.80	0.80	4.10	3.20	20.50	0.25		
RF50/FI/VR	4.80	0.80	4.10	5.00	20.50			RED
RF66/FI/VR	6.40	0.80	4.10	6.70	22.00			
BF50/FI/VR	4.80	0.80	4.90	5.00	21.50	0.40	0.80	BLUE
BF66/FI/VR	6.40	0.80	4.90	6.70	22.50			
YF66/FI/VR	6.40	0.80	6.70	6.70	25.00			YELLOW

+ PIGGY BACK TERMINALS

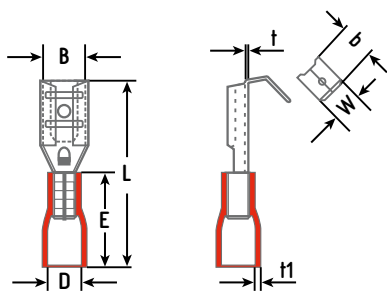

CAT NO	TAB WIDTH	TAB THICKNESS	DIMENSIONS (mm)					INSULATION COLOUR	
			D	B	L	E	t		t1
RPB63/VR	6.40	0.80	4.10	6.70	22.50	10.50	0.40	0.80	RED
BPB63/VR	6.40	0.80	4.90	6.70	23.00	11.00	0.40	0.80	BLUE

+ RELATED PRODUCTS



CRIMPING TOOLS

▶ PAGE 50



CRIMPER KITS

▶ PAGE 72



INFORMATION

- + In response to numerous requests from customers we have now added 90° angled pre-insulated terminals to our range.
- + Any of our standard range of Ring, Fork or Blade terminals can be supplied in this form
- + To order, add RA to the end of the part number, as shown below.
- + If you require further information, please contact our sales department.



PART NUMBERS

e.g.

BR64 RA

a 90° blue ring terminal with a 6.4mm hole



RELATED PRODUCTS

**CRIMPING TOOLS**

▶ PAGE 50

PRE-INSULATED CRIMP TERMINALS KITS

+ KIT-INS1 - CONTAINING

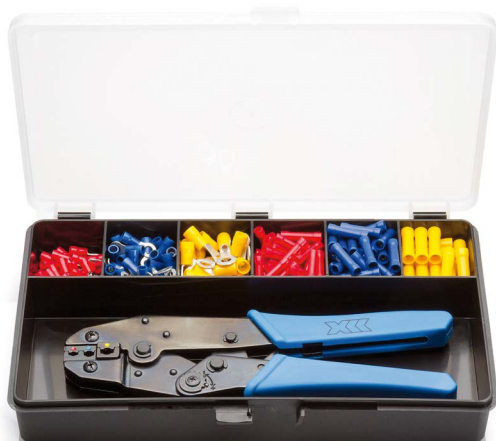

+ 1 x CT15 ratchet crimping tool

Plus:

50 x RR43	Red ring 4.3mm
50 x BR53	Blue ring 5.3mm
25 x YR64	Yellow ring 6.4mm
50 x RBC4	Red butt connector
50 x BBC45	Blue butt connector
25 x YBC68	Yellow butt connector

To order this kit with a calibration certificate use catalogue number: **KIT-INS1CAL**

+ KIT-INS2 - CONTAINING



+ 1 x CT15 ratchet crimping tool

Plus:

50 x RM63/VR	Red male tab
25 x RF66/FI/VR	Red FI push on
50 x BM63/VR	Blue male tab
25 x BF66/FI/VR	Blue FI push on
50 x RBC4	Red butt connector
50 x BBC45	Blue butt connector

To order this kit with a calibration certificate use catalogue number: **KIT-INS2CAL**

+ KIT-HSB1 - CONTAINING



+ 1 x CT-HSB ratchet crimping tool

Plus:

50 x HSB1.25	Red 0.5 - 1.5mm ²
50 x HSB2.0	Blue 2.5mm ²
40 x HSB5.5	Yellow 4.0 - 6.0mm ²

To order this kit with a calibration certificate use catalogue number: **KIT-HSB1CAL**

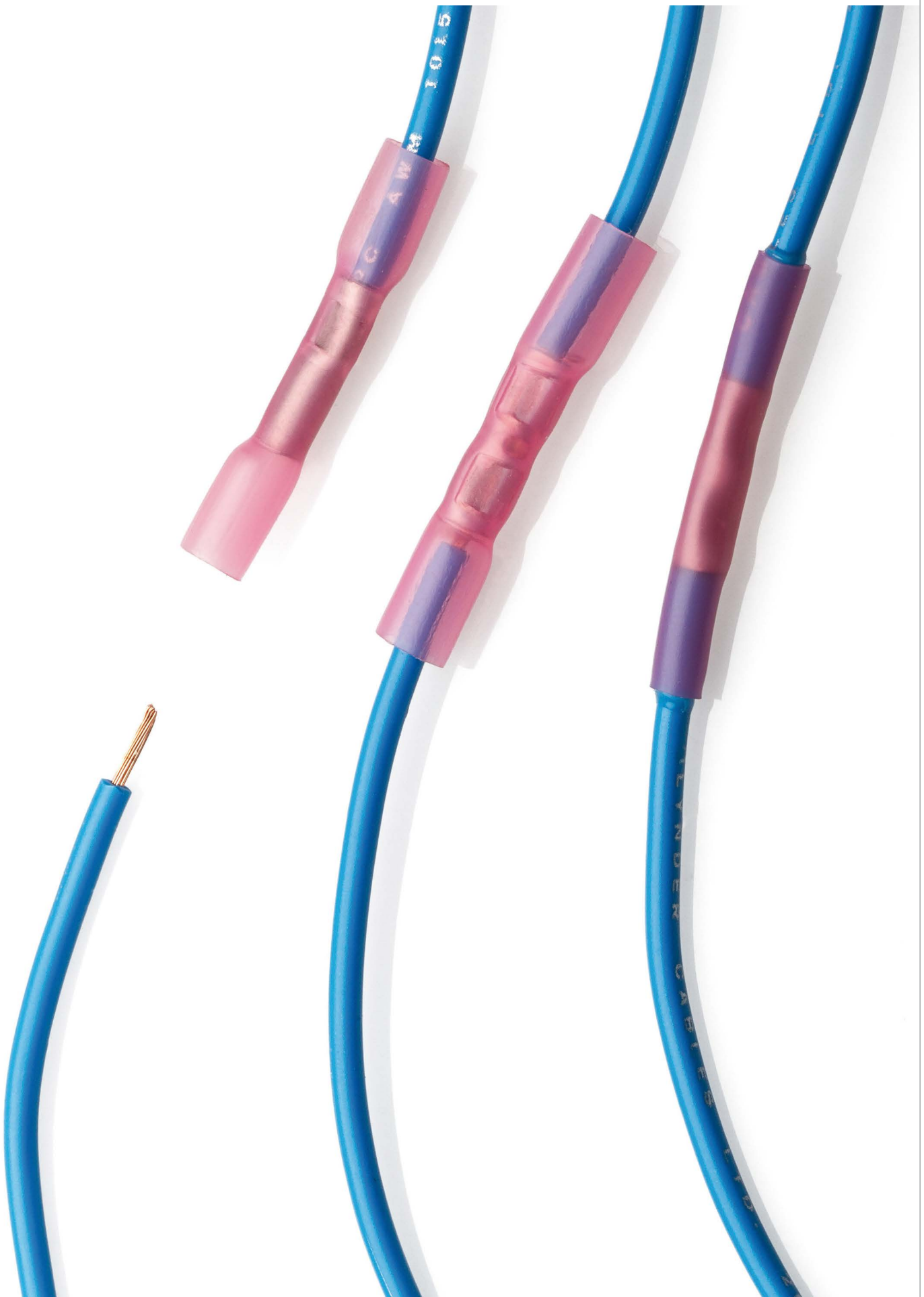

HEAT-SHRINK BUTT CONNECTORS



+ INFORMATION

- + Easy and quick to use one piece construction, that is resistant to water and contaminants.
- + Manufactured from tin coated high conductivity copper which provides a strong and durable connection.
- + High grade heat-shrinkable Polyolefin insulation ensures complete integrity of the termination.
- + Transparent outer sleeve allows for visual inspection of the joint.
- + Crimp the terminal, then apply heat to seal the joint permanently.

+ PROPERTIES

Shrink Temperature
100°C

Insulation Material
Heat-shrinkable Polyolefin

Maximum Voltage
600 Volt

Specification

Red insulation: Conductor size 0.5 - 1.5mm² / 22-16 awg
Blue insulation: Conductor size 1.5 - 2.5mm² / 16-14 awg
Yellow insulation: Conductor size 4.0 - 6.0mm² / 12-10 awg

Packaging

Supplied in bags of 100

+ DIMENSIONS

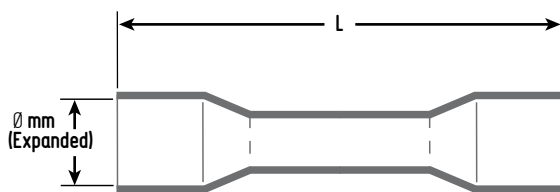

PART NUMBER	WIRE RANGE		LENGTH L (mm)	COLOUR
	AWG	mm ²		
HSB 0,5	24-20	0,25 - 0,5	29	CLEAR
HSB 1.25	22-16	0,5 - 1,5	37	RED
HSB 2.0	16-14	1,5 - 2,5	37	BLUE
HSB 5.5	12-10	4 - 6	42	YELLOW

+ RELATED PRODUCTS



CRIMPING TOOLS

▶ PAGE 53



CRIMPER KITS

▶ PAGE 72



HG2 - Hot air gun

▶ PAGE 62



+ INFORMATION

- + Easy and quick to use one piece construction, that is resistant to water and contaminants (IP67).
- + The lead free solder provides a strong and durable connection, without crimping.
- + High grade heat-shrinkable Polyolefin insulation ensures complete integrity of the termination.
- + Transparent outer sleeve allows for visual inspection of the joint.
- + Apply heat to solder the cables together and seal the joint permanently.

+ PROPERTIES

Shrink Temperature
100°C

Insulation Material
Heat-shrinkable Polyolefin with integrated meltable thermoplastic adhesive rings

Maximum Voltage
600 Volt

Specification

Red insulation: Conductor size 0.5 - 1.5mm² / 22-16 awg
 Blue insulation: Conductor size 1.5 - 2.5mm² / 16-14 awg
 Yellow insulation: Conductor size 4.0 - 6.0mm² / 12-10 awg

+ DIMENSIONS

PART NUMBER	WIRE RANGE		L (mm)	Ø (mm)	A (mm)	COLOUR	PACK QUANTITY
	AWG	mm ²					
SHSB-1	38-28	0.1 - 0.5	26	1.5	15	WHITE	10
SHSB-2	22-18	0.5 - 1.5	42	3.0	15	RED	25
SHSB-3	16-14	1.5 - 2.5	42	4.5	15	BLUE	25
SHSB-4	12-10	3.2 - 6.0	42	6.0	15	YELLOW	10

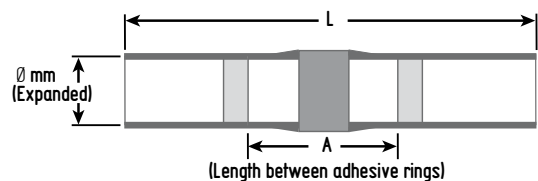

+ RELATED PRODUCTS



HG2 - Hot air gun

▶ PAGE 62

PRE-INSULATED FLAG TERMINALS

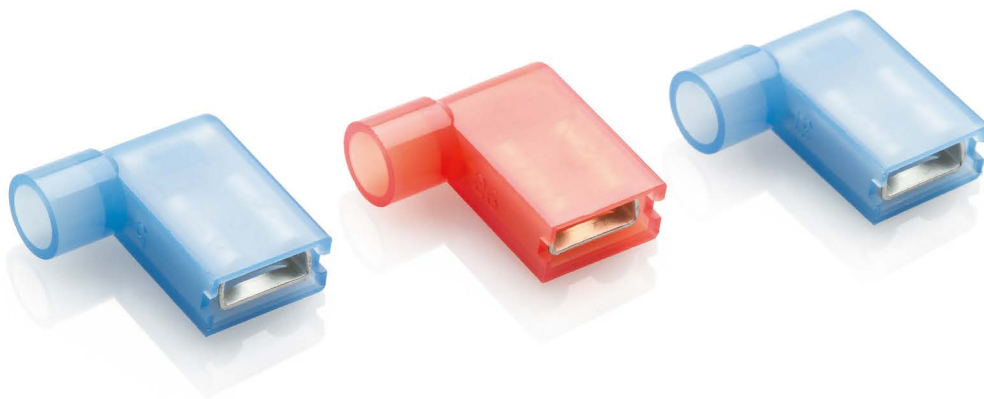

+ INFORMATION

- + Flag terminals are a 90° push-on terminal, ideal for use in tight spaces.
- + Manufactured from tin coated high conductivity brass.
- + Nylon insulation ensures complete integrity of the termination.
- + Must be crimped using the Partex CT-FLAG tool.

+ PROPERTIES

Temperature range
-20°C to +105°C

Insulation Material
Nylon

Maximum Voltage
300 Volt

Terminal Material
C2680 Brass

Packaging
Supplied in bags of 100

Specification
Red insulation: Conductor size 0.5 - 1.5mm² / 22-16 awg
Blue insulation: Conductor size 1.5 - 2.5mm² / 16-14 awg

+ DIMENSIONS

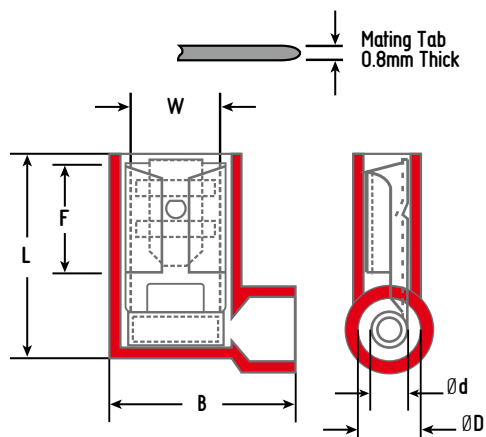

+ RELATED PRODUCTS



CT-FLAG CRIMPING TOOL

▶ PAGE 53

CAT NO	DIMENSIONS (mm)				Ø d	Ø D	INSULATION COLOUR
	W	L	F	E			
RF66/FI/FLAG	6.6	16.1	7.9	15	1.7	4.5	RED
BF66/FI/FLAG	6.6	16.1	7.9	15	2.3	4.5	BLUE

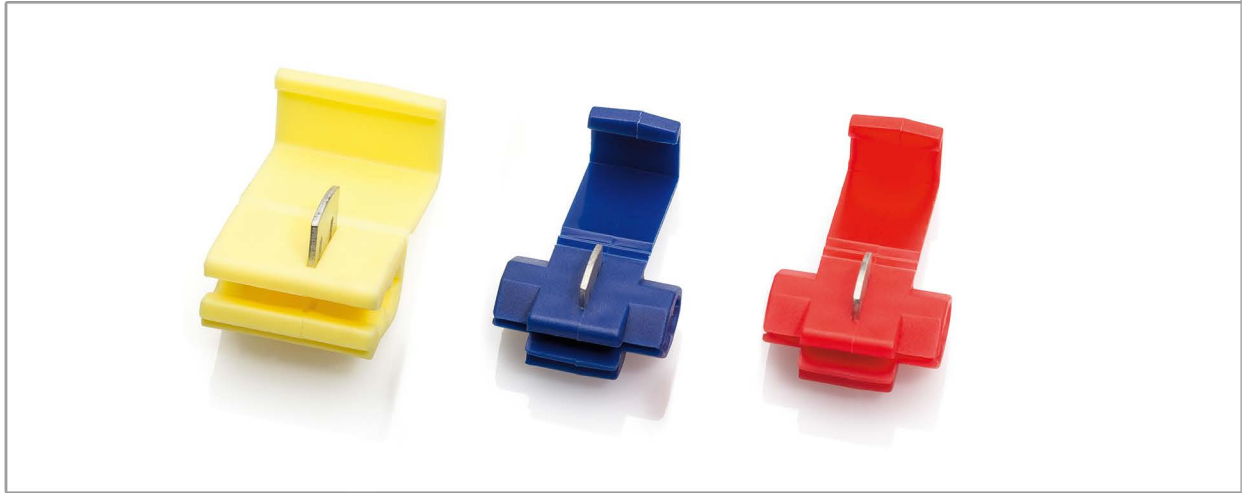

+ INFORMATION

- + Easy to use Quick Splice connectors
- + Can be used to tap off an existing cable without the need to remove the insulation.
- + Simply squeeze the metal tooth down onto the cables with pliers, then close the insulated cover
- + Ideal for automotive applications.

+ PROPERTIES

Temperature range
-20°C to +105°C

Insulation Material
Flame retardant Polypropylene

Maximum Voltage
600 Volt

UL Approval numbers
E482299

Terminal Material
Tin Plated Brass

Approvals
UL File number E482299

Packaging
Supplied in bags of 50



File No
E482299



+ DIMENSIONS

PART NUMBER	CABLE SIZE RANGE		DIMENSIONS (mm)	COLOUR
	AWG	mm ²		
QS1	22 - 16	0.5 - 1.5	32 x 20	RED
QS2	16 - 14	1.5 - 2.5	32 x 20	BLUE
QS3	12 - 10	4.0 - 6.0	32 x 20	YELLOW

UN-INSULATED CRIMP TERMINAL



INFORMATION

- + A comprehensive range of un-insulated Crimp Terminals.
- + Manufactured from tin coated high conductivity copper and brass.
- + Meet the requirements of BS EN and international standards.



PROPERTIES

Temperature range

-20°C to +75°C

Insulation Material

None

Specification

(Red) Conductor size 0.5 - 1.5mm² / 22-16 awg

(Blue) Conductor size 1.5 - 2.5mm² / 16-14 awg

(Yellow) Conductor size 4.0 - 6.0mm² / 12-10 awg

Approvals

UL File number E482299/E482300.

Packaging

Supplied in bags of 100

STANDARD TERMINALS:

Maximum Voltage

600 Volt

UL Approval numbers

UL File number E482299/E482300

Terminal Material

C1100 Copper

TABS AND RECEPTACLES:

Maximum Voltage

300 Volt

UL Approval numbers

E482299/E482300

Terminal Material

C2680 Brass



File No
E482299



RELATED PRODUCTS



CRIMPING TOOLS

▶ PAGE 52

UN-INSULATED CRIMP TERMINALS

+ RING TERMINALS

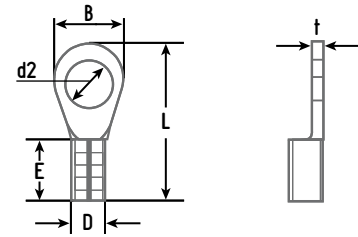

CAT NO	DIMENSIONS (mm)					
	d2	B	L	D	E	t
URR32	3.20	5.50	11.50			
URR37	3.70	5.50	11.50			
URR43	4.30	8.00	15.80			
URR53	5.30	8.00	15.80	3.45	4.30	0.75
URR64	6.40	11.60	21.50			
URR84	8.40	11.60	21.50			
UBR37	3.70	6.60	14.40			
UBR43	4.30	8.50	16.80			
UBR53	5.30	9.50	16.80			
UBR64	6.40	12.00	21.20	4.00	5.40	0.80
UBR84	8.40	12.00	21.20			
UBR105	10.50	13.70	25.50			
UYR53	5.30	9.50	19.50			
UYR64	6.40	12.00	25.50	5.70	7.00	1.00
UYR84	8.40	15.00	27.70			

+ FORK/SPADE TERMINALS

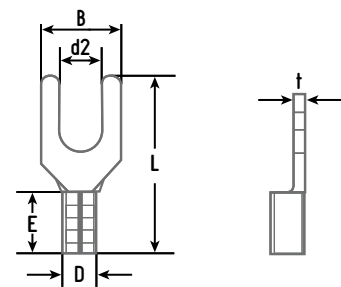

CAT NO	DIMENSIONS (mm)					
	d2	B	L	D	E	t
URS32	3.20	5.70	16.00			
URS37	3.70	6.20	16.00			
URS43	4.30	7.20	16.00			
URS53	5.30	8.00	16.00			
UBS37	3.70	6.20	16.00	4.00	5.40	0.80
UYS64	6.40	12.00	23.00	5.70	7.00	1.00

UN-INSULATED CRIMP TERMINALS

+ BLADE TERMINALS

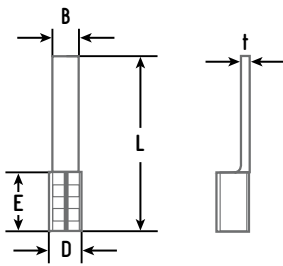

CAT NO	DIMENSIONS (mm)				
	B	L	D	E	t
URB18	2.45	23.00	3.45	4.30	0.75
UBB18	2.45	23.00	4.10	5.10	0.80



+ PIN TERMINALS

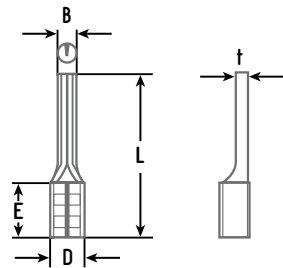

CAT NO	DIMENSIONS (mm)				
	B	L	D	E	t
UBP10	2.00	14.50	3.45	4.30	0.80



+ FLANGED FORK/SPADE

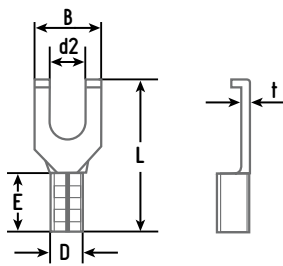

CAT NO	DIMENSIONS (mm)				
	B	L	D	E	t
UBFS43	7.20	14.10	3.45	4.30	0.80



+ FEMALE PUSH ON

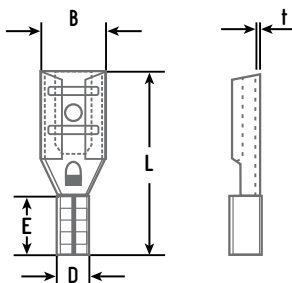

CAT NO	DIMENSIONS (mm)				
	B	L	D	E	t
URF66	6.70	16.10	3.00	5.40	0.40





+ INFORMATION

- + A comprehensive range of Copper Tube Crimp Terminals from 1.5mm² up to 400mm².
- + Manufactured from seamless high conductivity copper tube electroplated with tin to improve corrosion resistance.
- + The internal barrel diameters are designed to suit standard electrical cables according to BS6360.
- + Cable entries are bell shaped to allow easier insertion of the cable.
- + Each terminal has an inspection window to ensure the cable is fully inserted before crimping.

+ PROPERTIES

Maximum Temperature
+180°C

Copper Purity
>99.9%



File No
E482299



Material
Copper to BS EN 1976
Annealed to ASTM B111 C11000

+ DESCRIPTION

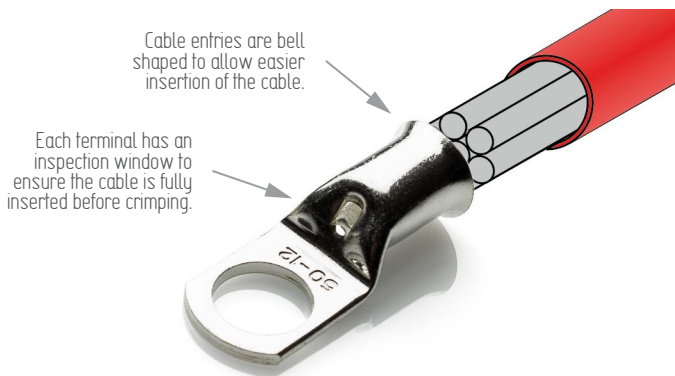

+ PART NUMBERS

e.g. COL 120-10

Cable size Stud Hole size

+ RELATED PRODUCTS



CRIMPING TOOLS

▶ PAGE 54



CRIMPER KITS

▶ PAGE 87



HYDRAULIC TOOLS

▶ PAGE 57



ANGLED TERMINALS

▶ PAGE 86

COL RANGE COPPER TUBE TERMINALS

+

DIMENSIONS

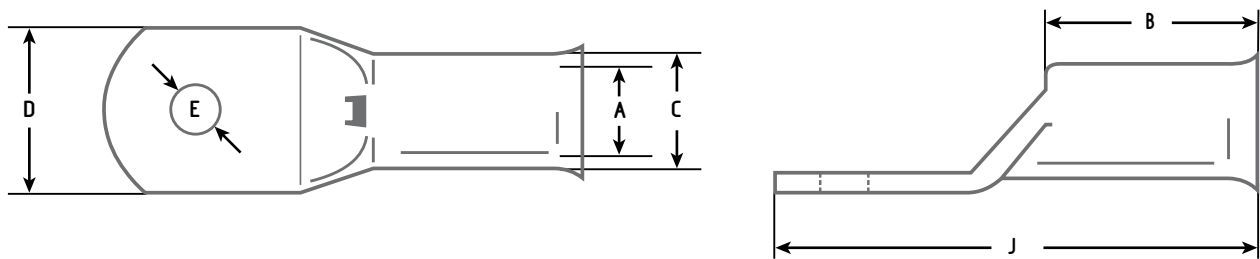

PART NUMBER	CABLE SIZE (mm ²)	E STUD HOLE DIA Ø (mm)	A ID (mm)	C OD (mm)	D PALM WIDTH (mm)	B BARREL LENGTH (mm)	J TOTAL LENGTH (mm)
COL 1.5-4	1.5	4.2	1.8	3.7	8.0	8.0	19.0
COL 1.5-5	1.5	5.2	1.8	3.7	8.0	8.0	20.0
COL 2.5-4	2.5	4.5	2.4	4.0	8.7	8.0	20.0
COL 2.5-5	2.5	5.2	2.4	4.0	8.7	8.0	21.0
COL 2.5-6	2.5	6.2	2.4	4.0	10.3	8.0	23.0
COL 4-4	4.0	4.2	3.1	4.8	8.7	10.0	22.0
COL 4-5	4.0	5.2	3.1	4.8	8.7	10.0	23.0
COL 4-6	4.0	6.5	3.1	4.8	10.3	10.0	25.0
COL 4-8	4.0	8.2	3.1	4.8	12.5	10.0	29.0
COL 6-4	6.0	4.2	3.8	5.5	8.7	10.0	21.0
COL 6-5	6.0	5.2	3.8	5.5	10.3	10.0	23.0
COL 6-6	6.0	6.5	3.8	5.5	10.3	10.0	24.0
COL 6-8	6.0	8.4	3.8	5.5	12.0	10.0	26.0
COL 6-10	6.0	10.2	3.8	5.5	14.0	10.0	30.0
COL 10-5	10.0	5.2	4.5	6.2	10.0	10.0	25.0
COL 10-6	10.0	6.4	4.5	6.2	10.0	10.0	25.0
COL 10-8	10.0	8.4	4.5	6.2	12.0	10.5	29.0
COL 10-10	10.0	10.2	4.5	6.2	15.0	10.5	34.0
COL 10-12	10.0	13.0	4.5	6.2	17.0	10.5	39.0
COL 16-5	16.0	5.2	5.4	7.1	12.0	12.0	25.0
COL 16-6	16.0	6.4	5.4	7.1	12.0	12.0	27.0
COL 16-8	16.0	8.4	5.4	7.1	12.5	12.0	31.0
COL 16-10	16.0	10.4	5.4	7.1	15.0	12.5	36.0
COL 16-12	16.0	13.0	5.4	7.1	17.0	12.5	41.0
COL 25-5	25.0	5.2	7.0	8.8	13.0	12.5	30.0
COL 25-6	25.0	6.4	7.0	8.8	13.0	12.5	30.0
COL 25-8	25.0	8.4	7.0	8.8	14.0	12.5	32.0
COL 25-10	25.0	10.4	7.0	8.8	16.0	12.5	37.0
COL 25-12	25.0	13.0	7.0	8.8	18.0	12.5	41.0
COL 35-6	35.0	6.4	8.6	10.8	16.0	15.0	36.0
COL 35-8	35.0	8.4	8.6	10.8	16.0	15.0	36.0
COL 35-10	35.0	10.4	8.6	10.8	16.0	15.0	40.0
COL 35-12	35.0	13.0	8.6	10.8	18.0	15.0	44.0
COL 35-14	35.0	14.6	8.6	10.8	19.8	15.0	47.0
COL 35-16	35.0	17.0	8.6	10.8	23.0	15.0	49.0
COL 50-6	50.0	6.4	9.6	11.8	17.5	16.0	42.0
COL 50-8	50.0	8.4	9.6	11.8	17.5	16.0	42.0
COL 50-10	50.0	10.4	9.6	11.8	17.5	16.0	42.0
COL 50-12	50.0	13.0	9.6	11.8	17.5	16.0	42.0
COL 50-14	50.0	15.0	9.6	11.8	17.5	16.0	46.0
COL 50-16	50.0	17.0	9.6	11.8	24.0	16.0	52.0

+ DIMENSIONS

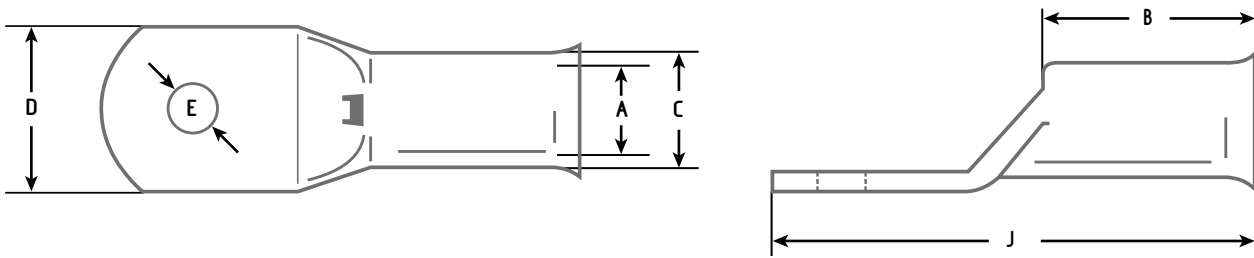

PART NUMBER	CABLE SIZE (mm ²)	E STUD HOLE DIA Ø (mm)	A ID (mm)	C OD (mm)	D PALM WIDTH (mm)	B BARREL LENGTH (mm)	J TOTAL LENGTH (mm)
COL 70-6	70.0	6.4	12.0	15.0	22.0	18.0	50.0
COL 70-8	70.0	8.4	12.0	15.0	22.0	18.0	50.0
COL 70-10	70.0	10.4	12.0	15.0	22.0	18.0	54.0
COL 70-12	70.0	13.0	12.0	15.0	22.0	18.0	54.0
COL 70-14	70.0	14.5	12.0	15.0	22.0	18.0	63.0
COL 70-16	70.0	17.0	12.0	15.0	22.0	18.0	63.0
COL 95-8	95.0	8.4	13.5	16.5	24.4	20.0	52.0
COL 95-10	95.0	10.4	13.5	16.5	24.4	20.0	52.0
COL 95-12	95.0	13.0	13.5	16.5	24.4	20.0	52.0
COL 95-14	95.0	15.0	13.5	16.5	24.4	20.0	56.0
COL 95-16	95.0	17.0	13.5	16.5	24.4	20.0	56.0
COL 120-8	120.0	8.4	15.0	19.0	27.8	22.0	55.0
COL 120-10	120.0	10.5	15.0	19.0	27.8	22.0	55.0
COL 120-12	120.0	13.0	15.0	19.0	27.8	22.0	55.0
COL 120-14	120.0	15.0	15.0	19.0	27.8	22.0	59.0
COL 120-16	120.0	17.0	15.0	19.0	27.8	22.0	59.0
COL 120-20	120.0	21.0	15.0	19.0	27.8	22.0	69.0
COL 150-8	150.0	8.4	16.5	21.0	30.7	27.0	64.0
COL 150-10	150.0	10.5	16.5	21.0	30.7	27.0	64.0
COL 150-12	150.0	13.0	16.5	21.0	30.7	27.0	64.0
COL 150-14	150.0	15.0	16.5	21.0	30.7	27.0	64.0
COL 150-16	150.0	17.0	16.5	21.0	30.7	27.0	64.0
COL 150-20	150.0	21.0	16.5	21.0	30.7	27.0	72.0
COL 185-10	185.0	10.5	19.0	23.1	33.5	27.0	67.0
COL 185-12	185.0	13.0	19.0	23.1	33.5	27.0	67.0
COL 185-14	185.0	15.0	19.0	23.1	33.5	27.0	67.0
COL 185-16	185.0	17.0	19.0	23.1	33.5	27.0	67.0
COL 185-20	185.0	21.0	19.0	23.1	33.5	27.0	75.0
COL 240-10	240.0	10.5	21.0	26.0	37.6	33.0	76.0
COL 240-12	240.0	13.0	21.0	26.0	37.6	33.0	76.0
COL 240-14	240.0	15.0	21.0	26.0	37.6	33.0	76.0
COL 240-16	240.0	17.0	21.0	26.0	37.6	33.0	76.0
COL 240-20	240.0	21.0	21.0	26.0	37.6	33.0	82.0
COL 300-10	300.0	10.5	24.5	30.0	44.0	42.0	95.0
COL 300-12	300.0	13.0	24.5	30.0	44.0	42.0	95.0
COL 300-14	300.0	15.0	24.5	30.0	44.0	42.0	95.0
COL 300-16	300.0	17.0	24.5	30.0	44.0	42.0	95.0
COL 300-20	300.0	21.0	24.5	30.0	44.0	42.0	95.0
COL 400-12	400.0	13.0	27.0	32.2	47.2	44.0	102.0
COL 400-14	400.0	15.0	27.0	32.2	47.2	44.0	102.0
COL 400-16	400.0	17.0	27.0	32.2	47.2	44.0	102.0
COL 400-20	400.0	21.0	27.0	32.2	47.2	44.0	102.0

COL RANGE COPPER TUBE TERMINALS



+ DIMENSIONS

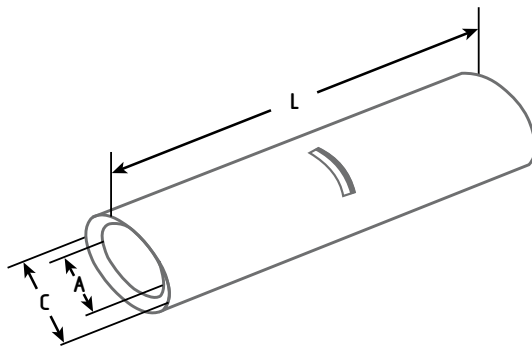

PART NUMBER	CABLE SIZE (mm ²)	A - INTERNAL DIAMETER (mm)	C - EXTERNAL DIAMETER (mm)	L - LENGTH (mm)
COL 1.5 B	1.5	1.8	3.7	16
COL 2.5 B	2.5	2.3	3.9	20
COL 4 B	4	3.0	4.7	20
COL 6 B	6	4.0	5.9	20
COL 10 B	10	4.5	6.6	23
COL 16 B	16	5.5	7.5	30
COL 25 B	25	6.7	9.1	35
COL 35 B	35	8.6	11.0	40
COL 50 B	50	9.5	12.4	40
COL 70 B	70	12.0	15.0	45
COL 95 B	95	13.4	17.0	45
COL 120 B	120	15.0	19.0	50
COL 150 B	150	16.5	21.2	55
COL 185 B	185	19.0	23.0	60
COL 240 B	240	21.0	26.5	60
COL 300 B	300	24.5	30.0	70
COL 400 B	400	27.0	36.5	80

+ RELATED PRODUCTS



CRIMPING TOOLS

▶ PAGE 54



CRIMPER KITS

▶ PAGE 87



HYDRAULIC TOOLS

▶ PAGE 57



+ INFORMATION

- + Partex Flat/Reducing pins are designed to ensure a safe and secure connection of your cable conductor.
- + The shape also allows for oversized cables to be fitted into smaller cable terminals.
- + To fit standard electrical cables to BS6360.

+ PROPERTIES

Maximum Temperature
+85°C to +180°C

Material
Made from Copper to BS EN 1976.
Electroplated Tin coating.
Brazen seam.

Approvals
Meets the compression requirements of
BS EN 61238.1:2003

+ DIMENSIONS

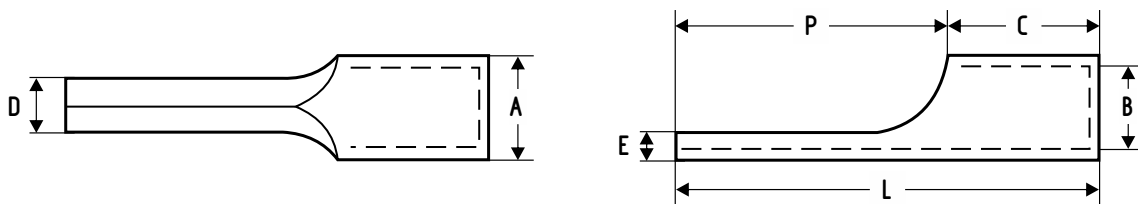

PART NUMBER	CABLE SIZE (mm ²)	Dimensions (mm)							
		A	B	C	D	E	P	L	
PXP 1.5	1.5	3.2	1.6	5.0	1.9	0.8	12.0	17.0	
PXP 2.5	2.5	3.9	2.3	5.0	1.9	0.8	12.0	17.0	
PXP 4	4.0	4.9	2.9	6.0	2.7	1.0	14.0	20.0	
PXP 6	6.0	5.6	3.6	6.0	2.7	1.0	14.0	20.0	
PXP 10	10.0	6.7	4.5	8.0	4.3	1.0	14.0	22.0	
PXP 16	16.0	8.2	5.8	10.0	5.5	1.2	17.0	26.0	
PXP 25	25.0	11.0	7.5	11.0	7.2	3.8	22.0	33.0	
PXP 35	35.0	13.0	9.0	12.0	8.2	3.8	21.0	33.0	
PXP 50	50.0	14.0	10.5	16.0	9.0	3.8	25.0	41.0	
PXP 70	70.0	16.0	12.0	16.0	10.0	4.1	30.0	46.0	
PXP 95	95.0	18.1	13.5	20.0	10.0	4.6	31.0	51.0	

ANGLED COPPER TUBE TERMINALS



+ INFORMATION

- + In response to numerous requests from customers we have now added 45° and 90° angled copper tube terminals to our COL range. (other angles available on request)
- + Any of our COL range of angled terminals from 10mm² up to 150mm² can be supplied from stock.
- + To order, add 45 or R/A to the end of the part number, as shown below.
- + If you require further information, please contact our sales department.

+ PART NUMBERS

e.g.

COL 120-10 R/A

Cable size Stud Hole size Right Angled

e.g.

COL 150-12 45

Cable size Stud Hole size 45° Angled

+ RELATED PRODUCTS



CRIMPING TOOLS

▶ PAGE 54



HYDRAULIC TOOLS

▶ PAGE 57

+ KIT-COL1 - CONTAINING



+ 1 x CT15-16 ratchet crimping tool

Plus:

50 x COL1.5-4	1.5mm ² - 4mm stud
50 x COL2.5-5	2.5mm ² - 5mm stud
50 x COL4-5	4.0mm ² - 5mm stud
50 x COL6-6	6.0mm ² - 6mm stud
50 x COL10-6	10mm ² - 6mm stud
25 x COL16-8	16mm ² - 8mm stud

To order this kit with a calibration certificate use catalogue number: **KIT-COL1CAL**

+ KIT-BUTT1 - CONTAINING



+ 1 x CT15-16 ratchet crimping tool

Plus:

100 x COL1.5B	Butt connector 1.5mm ²
100 x COL2.5B	Butt connector 2.5mm ²
50 x COL4B	Butt connector 4.0mm ²
50 x COL6B	Butt connector 6.0mm ²
25 x COL10B	Butt connector 10mm ²
25 x COL16B	Butt connector 16mm ²

To order this kit with a calibration certificate use catalogue number: **KIT-BUTT1CAL**





+ INFORMATION

- + A comprehensive range of Copper Tube Crimp Terminals up to 630mm².
- + Manufactured from seamless high conductivity copper tube electroplated with tin to improve corrosion resistance.
- + The internal barrel diameters are designed to suit standard electrical cables according to BS6360.
- + Each terminal has an inspection window to ensure the cable is fully inserted before crimping.

+ PROPERTIES

Maximum Temperature
+180°C

Copper Purity
>99.9%



File No
E482299



Material
Copper to BS EN 1976
Annealed to ASTM B111 C11000

+ PART NUMBERS



+ RELATED PRODUCTS



HYDRAULIC TOOLS

▶ PAGE 57

PXL RANGE COPPER TUBE TERMINALS

+

DIMENSIONS

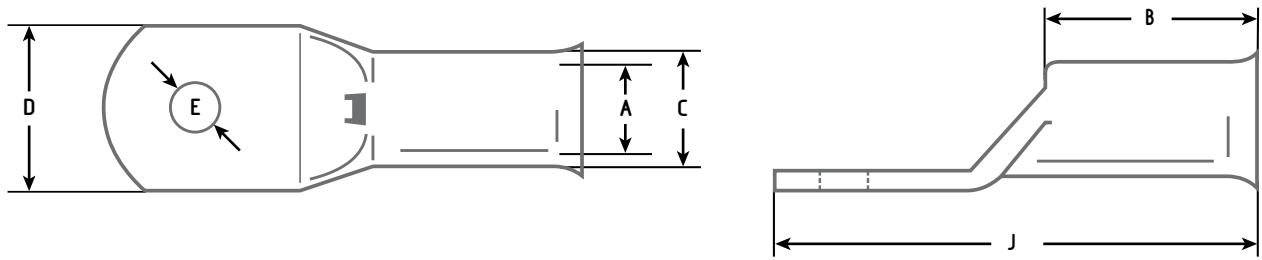

PART NUMBER	CABLE SIZE (mm ²)	E STUD HOLE DIA Ø (mm)	A ID (mm)	C OD (mm)	D PALM WIDTH (mm)	B BARREL LENGTH (mm)	J TOTAL LENGTH (mm)
PXL14	1.5	4	1.8	3.7	6.0	5.5	17.0
PXL15	1.5	5	1.8	3.7	6.0	5.5	17.0
PXL16	1.5	6	1.8	3.7	8.0	5.5	19.0
PXL24	2.5	4	2.4	4.0	8.0	8.0	21.5
PXL25	2.5	5	2.4	4.0	8.0	8.0	21.5
PXL26	2.5	6	2.4	4.0	8.0	8.0	21.5
PXL28	2.5	8	2.4	4.0	10.0	8.0	24.0
PXL44	4	4	3.1	4.8	9.0	8.0	21.0
PXL45	4	5	3.1	4.8	9.0	8.0	21.0
PXL46	4	6	3.1	4.8	9.0	8.0	21.0
PXL48	4	8	3.1	4.8	10.0	8.0	25.0
PXL65	6	5	3.8	5.5	10.0	10.0	23.0
PXL66	6	6	3.8	5.5	10.0	10.0	27.0
PXL68	6	8	3.8	5.5	10.0	10.0	27.0
PXL610	6	10	3.8	5.5	12.0	10.0	32.0
PXL105	10	5	4.5	6.2	12.0	10.0	25.5
PXL106	10	6	4.5	6.2	12.0	10.0	25.5
PXL108	10	8	4.5	6.2	12.0	10.0	25.5
PXL1010	10	10	4.7	7.1	12.0	10.0	32.0
PXL1012	10	12	4.7	7.1	14.0	10.0	36.0
PXL165	16	5	5.4	7.1	12.0	13.0	31.0
PXL166	16	6	5.4	7.1	12.0	13.0	31.0
PXL168	16	8	5.4	7.1	12.0	13.0	31.0
PXL1610	16	10	5.5	7.9	12.0	13.0	35.0
PXL1612	16	12	5.5	7.9	14.0	13.0	39.0
PXL208	20	8	6.0	7.7	12.0	14.0	32.5
PXL256	25	6	6.8	8.8	13.0	14.0	33.0
PXL258	25	8	6.8	8.8	13.0	14.0	33.0
PXL2510	25	10	6.8	8.8	13.0	14.0	36.5
PXL2512	25	12	6.8	8.8	14.0	14.0	40.0
PXL356	35	6	8.2	10.6	16.0	14.0	36.0
PXL358	35	8	8.2	10.6	16.0	14.0	36.0
PXL3510	35	10	8.2	10.6	16.0	14.0	39.0
PXL3512	35	12	8.2	10.6	16.0	15.5	47.0
PXL506	50	6	9.5	12.4	18.0	18.0	45.0
PXL508	50	8	9.5	12.4	18.0	18.0	45.0
PXL5010	50	10	9.5	12.4	18.0	18.0	45.0
PXL5012	50	12	9.5	12.4	18.0	18.0	52.0
PXL5014	50	14	9.5	12.4	19.0	18.0	52.0

PXL RANGE COPPER TUBE TERMINALS

PART NUMBER	CABLE SIZE (mm ²)	E STUD HOLE DIA Ø (mm)	A ID (mm)	C OD (mm)	D PALM WIDTH (mm)	B BARREL LENGTH (mm)	J TOTAL LENGTH (mm)
PXL5016	50	16	9.5	12.4	20.0	18.0	52.0
PXL706	70	6	11.2	14.7	21.0	20.0	52.0
PXL708	70	8	11.2	14.7	21.0	20.0	52.0
PXL7010	70	10	11.2	14.7	21.0	20.0	52.0
PXL7012	70	12	11.2	14.7	21.0	20.0	52.0
PXL7014	70	14	11.2	14.7	21.0	20.0	52.0
PXL7016	70	16	11.2	14.7	21.0	20.0	52.0
PXL7020	70	20	11.2	14.7	24.0	20.0	57.0
PXL958	95	8	13.5	17.4	25.0	22.0	57.0
PXL9510	95	10	13.5	17.4	25.0	22.0	57.0
PXL9512	95	12	13.5	17.4	25.0	22.0	57.0
PXL9514	95	14	13.5	17.4	25.0	22.0	57.0
PXL9516	95	16	13.5	17.4	25.0	22.0	60.0
PXL9520	95	20	13.5	17.4	25.0	22.0	60.0
PXL1208	120	8	15.0	19.4	28.0	24.0	63.0
PXL12010	120	10	15.0	19.4	28.0	24.0	63.0
PXL12012	120	12	15.0	19.4	28.0	24.0	63.0
PXL12014	120	14	15.0	19.4	28.0	24.0	63.0
PXL12016	120	16	15.0	19.4	28.0	24.0	63.0
PXL12020	120	20	15.0	19.4	28.0	24.0	70.0
PXL1508	150	8	16.5	21.2	30.0	29.0	71.0
PXL15010	150	10	16.5	21.2	30.0	29.0	71.0
PXL15012	150	12	16.5	21.2	30.0	29.0	71.0
PXL15014	150	14	16.5	21.2	30.0	29.0	71.0
PXL15016	150	16	16.5	21.2	30.0	29.0	71.0
PXL15020	150	20	16.5	21.2	30.0	29.0	71.0
PXL18510	185	10	18.5	23.5	34.0	34.0	79.0
PXL18512	185	12	18.5	23.5	34.0	34.0	79.0
PXL18514	185	14	18.5	23.5	34.0	34.0	79.0
PXL18516	185	16	18.5	23.5	34.0	34.0	79.0
PXL18520	185	20	18.5	23.5	34.0	34.0	79.0
PXL24010	240	10	21.0	26.5	38.0	39.0	93.0
PXL24012	240	12	21.0	26.5	38.0	39.0	93.0
PXL24014	240	14	21.0	26.5	38.0	39.0	93.0
PXL24016	240	16	21.0	26.5	38.0	39.0	93.0
PXL24020	240	20	21.0	26.5	38.0	39.0	93.0
PXL30010	300	10	23.5	30.0	43.0	44.0	101.0
PXL30012	300	12	23.5	30.0	43.0	44.0	101.0
PXL30014	300	14	23.5	30.0	43.0	44.0	101.0
PXL30016	300	16	23.5	30.0	43.0	44.0	101.0
PXL30020	300	20	23.5	30.0	43.0	44.0	101.0
PXL40010	400	10	26.8	34.8	50.0	47.0	116.0
PXL40012	400	12	26.8	34.8	50.0	47.0	116.0
PXL40014	400	14	26.8	34.8	50.0	47.0	116.0
PXL40016	400	16	26.8	34.8	50.0	47.0	116.0
PXL40020	400	20	26.8	34.8	50.0	47.0	116.0
PXL50016	500	16	30.0	39.0	55.5	52.0	126.0
PXL50020	500	20	30.0	39.0	55.5	52.0	126.0
PXL63016	630	16	35.0	45.0	64.0	59.0	146.0
PXL63020	630	20	35.0	45.0	64.0	59.0	146.0

CORD END (BOOTLACE) FERRULES



+ INFORMATION

- + A comprehensive range of insulated and un-insulated Cord End (Bootlace) Ferrules.
- + Manufactured from tin coated high conductivity copper.
- + High grade Polyamide 66 insulation ensures complete integrity of the termination.
- + Available in both the French and German standard colours.

+ PROPERTIES

Shrink Temperature

-40°C to +105°C

Material

Insulation: Polyamide 66, zero halogen
Terminal: High conductivity tin plated copper

Copper Purity

>99.9%

Specification

DIN 46228-1 and -4

Packaging

Available in bags of 100 or 1000
(please specify when ordering)

+ PRODUCT RANGE



STANDARD

▶ PAGE 93



LONG BARREL

▶ PAGE 94



TWIN FERRULES

▶ PAGE 95



UNINSULATED

▶ PAGE 96

+ RELATED PRODUCTS



CRIMPING TOOLS

▶ PAGE 59



CRIMPER KITS

▶ PAGE 97

STANDARD CORD END (BOOTLACE) FERRULES



+

DIMENSIONS

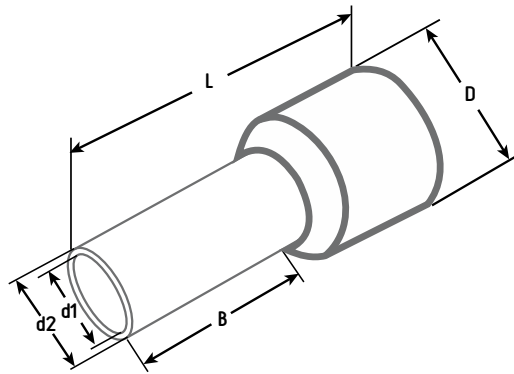

CAT NO	SIZE (mm ²)	DIMENSIONS (mm)					COLOUR			
		L	B	d1	d2	D	FRENCH		GERMAN	
CEF025_*	0.25	10	6	0.75	0.90	1.9	Violet		Light Blue	
CEF034_*	0.34	10	6	0.80	0.95	1.9	Pink		Turquoise	
CEF508_*	0.50	14	8	1.00	1.15	2.6	White		Orange	
CEF7508_*	0.75	14	8	1.20	1.35	2.8	Blue		White	
CEF108_*	1.0	14	8	1.40	1.55	3.0	Red		Yellow	
CEF1508_*	1.5	14	8	1.70	1.85	3.5	Black		Red	
CEF2508_*	2.5	14	8	2.20	2.35	4.2	Grey		Blue	
CEF409_*	4	16	9	2.80	3.00	4.8	Orange		Grey	
CEF612_*	6	20	12	3.50	3.70	6.3	Green		Black	
CEF1012_*	10	22	12	4.50	4.70	7.6	Brown		Ivory	
CEF1612_*	16	24	12	5.80	6.00	8.8	Ivory		Green	
CEF25016_*	25	28	16	7.30	7.50	11.2	Black		Brown	
CEF35016_*	35	30	16	8.30	8.50	13.0	Red		Beige	
CEF50020_*	50	37	20	10.30	11.0	16.0	Blue		Olive	
CEF70021F	70	37	21	13.40	14.40	17.6	Yellow		-	
CEF95025F	95	44	25	14.50	15.60	19.5	Red		-	

* When ordering add suffix „F“ for French and „G“ for German standard.

LONG BARRELLED CORD END (BOOTLACE) FERRULES



INFORMATION

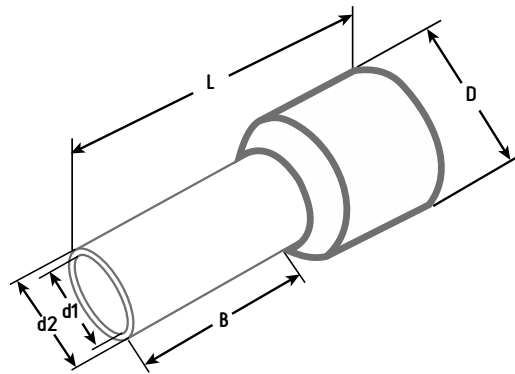

CAT NO	SIZE (mm ²)	DIMENSIONS (mm)					COLOUR			
		L	B	d1	d2	D	FRENCH		GERMAN	
CEF7512_*	0.75	18	12	1.20	1.35	2.8	Blue		White	
CEF112_*	1.0	18	12	1.40	1.55	3.0	Red		Yellow	
CEF1518_*	1.5	18	18	1.70	1.85	3.5	Black		Red	
CEF2518_*	2.5	24	18	2.20	2.35	4.2	Grey		Blue	
CEF418_*	4	26	18	2.80	3.00	4.8	Orange		Grey	
CEF618_*	6	26	18	3.50	3.70	6.3	Green		Black	
CEF1018_*	10	28	18	4.50	4.70	7.6	Brown		Ivory	
CEF1618_*	16	35	18	5.80	6.00	8.8	Ivory		Green	
CEF25022_*	25	35	22	7.30	7.50	11.2	Black		Brown	
CEF35025_*	35	39	25	8.30	8.50	13.0	Red		Beige	
CEF50025F	50	42	25	10.30	11.0	16.0	Blue		-	-

* When ordering add suffix „F“ for French and „G“ for German standard.



+ INFORMATION

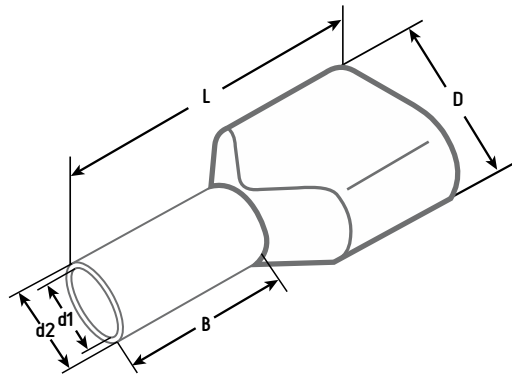

CAT NO	SIZE (mm ²)	DIMENSIONS (mm)					COLOUR			
		L	B	d1	d2	D	FRENCH		GERMAN	
TCEF508_*	2x 0.5	15,00	8,00	1,5	1,8	2.5/4.7	White		Orange	
TCEF7508_*	2x 0.75	15,00	8,00	1,8	2,2	2.8/5.0	Grey		White	
TCEF7510_*	2x 0.75	17,00	10,00	1,8	2,2	2.8/5.0	Grey		-	
TCEF108_*	2x 1.0	15,00	8,00	2,05	2,35	3.4/5.4	Red		Yellow	
TCEF110F	2x 1.0	17,00	10,00	2,05	2,35	3.4/5.4	Red		-	
TCEF1508_*	2x 1.5	16,00	8,00	2,3	2,6	3.6/6.6	Black		Red	
TCEF1512F	2x 1.5	20,00	12,00	2,3	2,6	3.6/6.6	Black		-	
TCEF2510_*	2x 2.5	18,50	10,00	2,8	3,2	4.2/7.8	Blue		Blue	
TCEF2513F_*	2x 2.5	21,50	13,00	2,8	3,2	4.2/7.8	Blue		-	
TCEF412_*	2x 4	23,00	12,00	3,7	4,3	4.9/8.8	Grey		Grey	
TCEF614_*	2x 6	26,00	14,00	4,8	5,2	6.9/10.0	Yellow		Black	
TCEF1014_*	2x 10	26,50	14,00	6,4	6,8	7.6/12.8	Red		Ivory	
TCEF1614_*	2x 16	31,50	14,00	8,3	8,9	9.6/18.6	Blue		Green	

* When ordering add suffix „F“ for French and „G“ for German standard.

UNINSULATED CORD END (BOOTLACE) FERRULES



+ DIMENSIONS

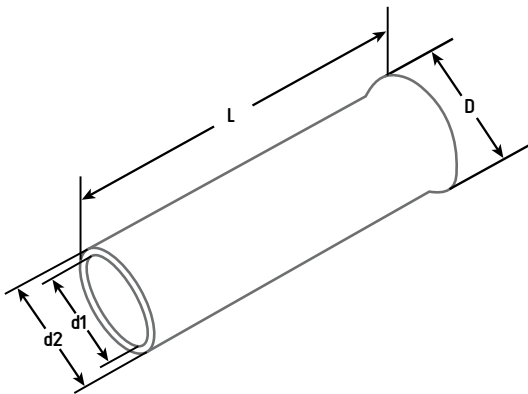

CAT NO	SIZE (mm ²)	DIMENSIONS (mm)			
		D1	d2	D	L
UCEF 510	0.50	1.0	1.3	2.1	10
UCEF 7510	0.75	1.2	1.5	2.3	10
UCEF 110	1.00	1.4	1.7	2.5	10
UCEF 1510	1.50	1.7	2	2.8	10
UCEF 2512	2.50	2.2	2.5	3.4	12
UCEF 412	4.0	2.8	3.2	4.0	12
UCEF 618	6.0	3.5	3.9	4.7	18
UCEF 1018	10.0	4.5	4.9	5.8	18
UCEF 1618	16.0	5.8	6.2	7.5	18
UCEF 25018	25.0	7.3	7.7	9.5	18
UCEF 35018	35.0	8.3	8.7	11.0	18
UCEF 50025	50.0	10.3	11.0	12.9	25
UCEF 70025	70.0	13.4	14.4	15.4	25
UCEF 95032	95.0	14.5	15.6	16.7	32

+ RELATED PRODUCTS



CRIMPING TOOLS

▶ PAGE 59

+ KIT-CEFO1F - CONTAINING



+ 1 x CEFT01 ratchet crimping tool

Plus:

- 100 x CEF025F 0.25mm² Violet
- 100 x CEF034F 0.34mm² Pink
- 100 x CEF508F 0.5mm² White
- 100 x CEF7508F 0.75mm² Blue
- 100 x CEF108F 1.0mm² Red
- 100 x CEF1508F 1.5mm² Black

To order this kit with a calibration certificate use catalogue number: **KIT-CEFO1FCAL**

+ KIT-CEFO1G - CONTAINING



+ 1 x CEFT01 ratchet crimping tool

Plus:

- 100 x CEF025G 0.25mm² Light Blue
- 100 x CEF034G 0.34mm² Green
- 100 x CEF508G 0.5mm² Orange
- 100 x CEF7508G 0.75mm² White
- 100 x CEF108G 1.0mm² Yellow
- 100 x CEF1508G 1.5mm² Red

To order this kit with a calibration certificate use catalogue number: **KIT-CEFO1GCAL**

CORD END (BOOTLACE) FERRULE KITS

+ KIT-CEF1F - CONTAINING



+ 1 x CEFT1 ratchet crimping tool

Plus:

100 x CEF508F	0.5mm ² White
100 x CEF7508F	0.75mm ² Blue
100 x CEF108F	1.0mm ² Red
100 x CEF1508F	1.5mm ² Black
100 x CEF2508F	2.5mm ² Grey
100 x CEF409F	4.0mm ² Orange

To order this kit with a calibration certificate use catalogue number: **KIT-CEF1FCAL**

+ KIT-CEF1G - CONTAINING



+ 1 x CEFT1 ratchet crimping tool

Plus:

100 x CEF508G	0.5mm ² Orange
100 x CEF7508G	0.75mm ² White
100 x CEF108G	1.0mm ² Yellow
100 x CEF1508G	1.5mm ² Red
100 x CEF2508G	2.5mm ² Blue
100 x CEF409G	4.0mm ² Grey

To order this kit with a calibration certificate use catalogue number: **KIT-CEF1GCAL**





+ INFORMATION

- + High quality 2:1 ratio heat shrink tubing in a wide range of sizes and colours
- + Available in various pack sizes to suit your requirements
- + Flame retardant, zero halogen
- + Weatherproof and UV stable

+ PROPERTIES

Working Temperature Range

-55°C to +125°C

Insulation Material

Cross-Linked Polyolefin (rated to 600V)

Shrink Temperature

90°C to +100°C

Approvals

UL File number E479774 (excluding clear)
Standard UL224 125°C



Available Colours

Black, Clear, Red, Yellow, Blue, White, Green,
Brown, Grey, and Earth (Green/Yellow)

+ DATA

PROPERTY	DATA	CONDITION
TENSILE STRENGTH	>10.4MPA	-
TENSILE STRENGTH AFTER AGING	>7.3MPA	158.0±1.0°C, 168HRS
ELONGATION	>200%	-
ELONGATION AFTER AGING	>100%	134°C 60 DAYS
LONGITUDINAL CHANGE	<±5%	-
RADIAL SHRINKING RATIO	>50%	-
FLAMMABILITY	VW-1	-
DIELECTRIC STRENGTH	>15KV/MM	-
VOLUME RESISTIVITY	10 ¹⁴ Ω-CM	-
CORROSION	NO CORROSION	-
COPPER STABILITY	>100%	-
CONCENTRICITY	>65%	-

+ DIMENSIONS



PARTEX PART NUMBER*	AS SUPPLIED		AFTER RECOVERY			PACK QUANTITY		
	INSIDE DIAMETER (D)		WALL THICKNESS	INSIDE DIAMETER (d)		WALL THICKNESS	BULK PACK	MINI BOX
	mm	inch	mm	mm	inch	mm	metres	metres
HS 212	≥1.2	3/64	0.20±0.08	≤0.6	3/128	0.33	150	20
HS 216	≥1.6	1/16	0.20±0.08	≤0.8	1/32	0.36	150	17
HS 224	≥2.4	3/32	0.20±0.09	≤1.0	3/64	0.44	150	15
HS 232	≥3.2	1/8	0.25±0.09	≤1.5	1/16	0.44	150	15
HS 248	≥4.8	3/16	0.25±0.09	≤2.0	3/32	0.44	75	12
HS 264	≥6.4	1/4	0.28±0.10	≤3.0	1/8	0.56	75	12
HS 295	≥9.5	3/8	0.30±0.12	≤4.5	3/16	0.56	75	8
HS 2127	≥12.7	1/2	0.30±0.12	≤6.0	1/4	0.56	50	8
HS 2191	≥19.1	3/4	0.38±0.15	≤10.0	3/8	0.77	50	5
HS 2254	≥25.4	1	0.42±0.15	≤12.5	1/2	0.77	30	5
HS 2381	≥38.1	1-1/2	0.50±0.15	≤21.0	3/4	0.87	30	N/A
HS 2508	≥50.8	2	0.50±0.15	≤27.0	1	0.97	30	N/A
HS 2762	≥76.2	3	0.70±0.30	≤38.1	1-1/2	1.40	15	N/A
HS 21016	≥101.6	4	0.70±0.30	≤50.8	2	1.40	15	N/A

+ ARTICLE NUMBERS



1. To order a **Bulk Reel** use the part number above, followed by the colour eg:

HS 295 Black

(75 metre reel of 9.5mm black heat shrink)



2. To order a **Mini Box** insert MB into the part number above, followed by the colour eg:

HSMB 127 Red

(8 metre box of 12.7mm red heat shrink)

+ RELATED PRODUCTS



SELECTION KITS

▶ PAGE 102



HG2 - Hot air gun

▶ PAGE 62



+ INFORMATION

- + High quality 2:1 ratio heat shrink tubing in a wide range of sizes
- + Assortment packs with a variety of colours, ready to use
- + Identical specification to our standard HS heat shrink range



+ ORDERING INFORMATION

PART REF	SIZE (mm)	CONTENTS
HS KIT1 3.2	3.2/1.6	Contains 3 X 250mm lengths of each colour*
HS KIT1 4.8	4.8/2.4	
HS KIT1 6.4	6.4/3.2	
HS KIT1 9.5	9.5/4.7	
HS KIT1 12.7	12.7/6.3	
HS KIT1 19.1	19.1/9.5	Contains 2 X 250mm lengths of each colour*
HS KIT1 25.4	25.4/12.7	
HS KIT1 38.1	38.1/19.0	

* black, blue, grey, brown and earth.

+ RELATED PRODUCTS



HG2 - Hot air gun

▶ PAGE 62



+ INFORMATION

- + High quality 2:1 ratio heat shrink tubing in a wide range of sizes
- + Assortment packs with a variety of colours, ready to use
- + Identical specification to our standard HS heat shrink range



File No
E479774



+ ORDERING INFORMATION

PART REF	SIZE (mm)	CONTENTS
HS KIT2 3.2	3.2/1.6	Contains 2 X 250mm lengths of each colour*
HS KIT2 4.8	4.8/2.4	
HS KIT2 6.4	6.4/3.2	
HS KIT2 9.5	9.5/4.7	
HS KIT2 12.7	12.7/6.3	
HS KIT2 19.1	19.1/9.5	
HS KIT2 25.4	25.4/12.7	
HS KIT2 38.1	38.1/19.0	

* red, yellow, green, black, blue, grey, brown, white, clear and earth.

+ RELATED PRODUCTS



HG2 - Hot air gun

▶ PAGE 62

HEAT SHRINK TUBING - ADHESIVE LINED 1.2 METRE LENGTHS



+ INFORMATION

- + High quality 3:1 ratio dual wall adhesive lined heat shrink tubing
- + Supplied in convenient 1.2metre lengths
- + Flame retardant, zero halogen
- + Weatherproof and UV stable

+ PROPERTIES

Working Temperature Range
-55°C to +125°C

Insulation Material
Cross-Linked Polyolefin (rated to 600V)

Shrink Temperature
100°C

Approvals
UL File number E479774
Standard UL224 125°C

Available Colours
Black only



+ DATA

PROPERTY	DATA	PROPERTY	DATA
RADIAL SHRINKING RATIO(%)	≥50	ULTIMATE ELONGATION RATIO (%)	≥100
TENSILE STRENGTH (MPA)	≥10.4	LONGITUDINAL CHANGE (%)	≥10
VOLUME RESISTIVITY (Ω CM)	10 ¹³	ULTIMATE ELONGATION RATIO (%)	≥200
FLAMMABILITY	VW 1	DIELECTRIC STRENGTH (KV/MM)	≥15
FLUID RESISTANCE	Excellent	WATER ABSORPTION (%)	<0.4
SOFTENING POINT	120± 5	COPPER CORROSION	NO CORROSION
AGING IN CIRCULATING AIR OVEN	158.0±1.0°C (168hrs)	TISSUE STRENGTH	>80
AFTER AGING TENSILE STRENGTH(MPA)	≥7.3		

+ RELATED PRODUCTS



HG2 - Hot air gun

▶ PAGE 62



PARTEX PART REFERENCE	AS SUPPLIED				AFTER RECOVERY					
	INSIDE DIAMETER (D)		WALL THICKNESS (T)		INSIDE DIAMETER (d)		TOTAL WALL THICKNESS (t)		ADHESIVE WALL	
	mm	inch	mm	inch	mm	inch	mm	inch	mm	inch
HSDW-3-3	3	1/8	0.57	0.022	1	0.039	1.00±0.28	0.039±0.010	0.50	0.020
HSDW-3-4.8	4.8	3/16	0.57	0.022	1.5	0.059	1.00±0.28	0.039±0.010	0.50	0.020
HSDW-3-6	6	1/4	0.57	0.022	2	0.079	1.05±0.28	0.041±0.010	0.60	0.024
HSDW-3-9	9	3/8	0.64	0.025	3	0.118	1.40±0.28	0.055±0.010	0.61	0.024
HSDW-3-12	12	1/2	0.80	0.031	4	0.157	1.78±0.38	0.070±0.010	0.76	0.030
HSDW-3-19	19	3/4	0.93	0.036	6	0.236	2.25±0.55	0.088±0.020	0.76	0.030
HSDW-3-24	24	1	1.00	0.040	8	0.315	2.54±0.55	0.100±0.020	1.02	0.040
HSDW-3-39	39	1-1/2	1.00	0.040	13	0.512	2.54±0.55	0.100±0.020	1.02	0.040

Supplied in 1.2 metre lengths, only available in black.

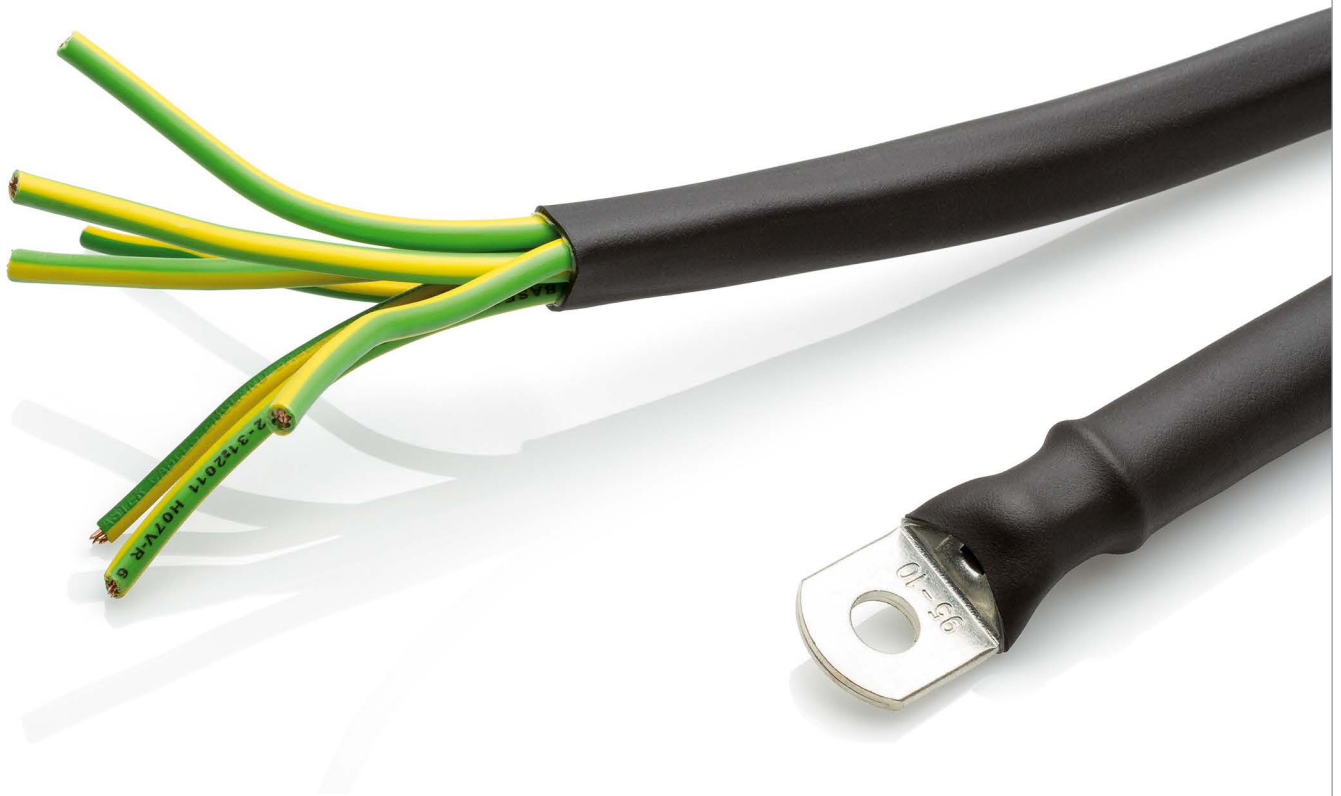

SUPAFLEX BRAIDED SLEEVING



INFORMATION

- + Supaflex braided sleeving is ideal for protecting and securing panel wiring
- + Easy to use and available in a wide range of sizes
- + Low smoke, zero halogen
- + Weatherproof and UV stable



PROPERTIES

Working Temperature Range
-55°C to +150°C

Material
Polyester

Melting Point
230°C

Approvals
Self-extinguishing to UL224 VW1

Available Colours
Black or Grey (specify when ordering)



DIMENSIONS

PARTEX PART NUMBER	NOMINAL DIAMETER (mm)	SIZE RANGE (mm)		STANDARD PACK QTY (m)
		minimum	maximum	
SUP4	4	2	7	10, 100
SUP6	6	4	11	10, 100
SUP8	8	5	12	10, 100
SUP10	10	7	15	10, 100
SUP12	12	8	17	10, 100
SUP15	15	10	21	10, 100
SUP20	20	14	27	10, 100
SUP25	25	18	34	10, 100
SUP30	30	28	47	10, 100
SUP40	40	35	64	10, 100
SUP50	50	45	75	10, 100

For best results cut with a hot knife or soldering iron to seal the ends and prevent fraying.

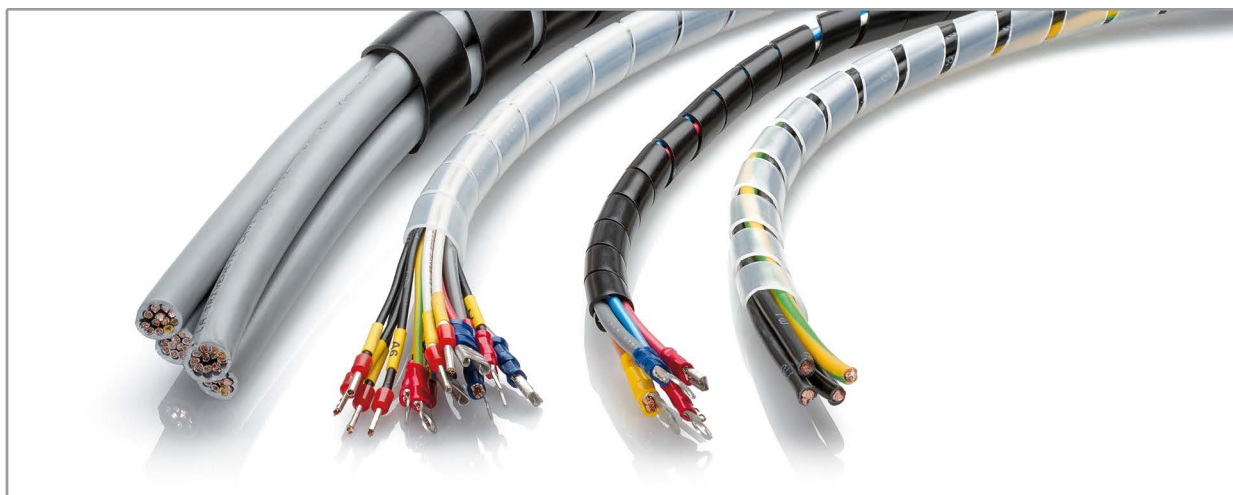

+ INFORMATION

- + Low cost spiral tubing for bundling wires and cables
- + Made from a highly flexible material which will follow any contour
- + Durable and re-useable, it will retain its spiral shape
- + Available in a wide range of sizes

+ PROPERTIES

Temperature Range
-20°C to +70°C

Standard colours
Black and Natural

Material
LDPE (Low Density Polyethylene)

Packaging
10metre bags

+ DIMENSIONS

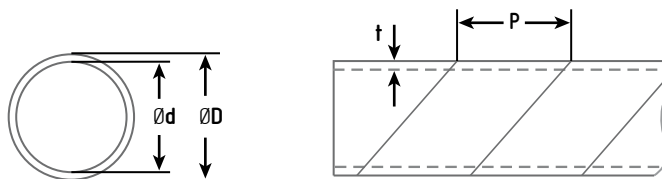

PARTEX PART NUMBER	WIDTH P (mm)	NOMINAL (mm)		WRAPPING RANGE (mm)
		D (mm)	d (mm)	
SW6	7.0	6.2	4.1	4-25
SW8	10.8	8.0	6.0	6-30
SW10	11.4	10.0	7.5	7.5-30
SW12	13.9	12.0	9.0	9-32
SW15	15.0	15.0	12.0	12-35
SW19	18.2	19.0	15.0	15-50

Please add suffix to part number N = Natural, B = Black.

SPIRAL TUBING



+ INFORMATION

- + Flexible spiral tube for fitting cables, conductors, tubes, wire bundles etc.
- + Excellent protection against mechanical wear.
- + Permits flexible connection between cabinet and door mounted units.
- + Also available in halogen free version (SPZ)

+ PROPERTIES

Temperature range
-30°C to +60°C

Material
PVC

Standard colour
grey, black

Packaging
one metre lengths

+ DIMENSIONS

TYPE	INTERNAL DIAMETER [mm]	OUTSIDE DIAMETER [mm]
SP-08	8	10
SP-10	10	13
SP-15	15	18.4
SP-20	20	24
SP-25	25	29
SP-30	30	34.6
SP-40	40	45
SP-50	50	55

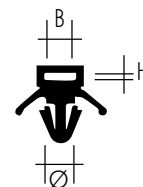

+ MOUNTING

TYPE	MAX. THICKNESS PLATE	MOUNTING HOLE	PACKAGING
SPH-1	3.2 mm	6.2 mm	50 pcs.

+ APPLICATION

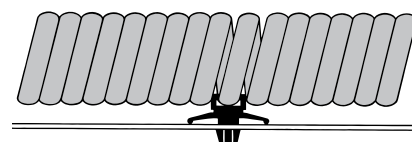



+ INFORMATION

- + High quality flame-retardant insulation tape
- + Extremely flexible with good adhesion
- + Available in a full range of colours

+ PROPERTIES

Storage Temperature

Below 21°C a 50% R.H

Material

PVC, natural rubber adhesive

Conforms to

BS EN 60454-1, BS EN 60454-2 and BS EN 60454-3.1

Packaging

pack of 10

Available Colours

Black, Red, Yellow, Blue, Green, White, Grey, Brown and Earth(Green/Yellow)

+ PROPERTY

PROPERTY	VALUE	TEST METHOD
TOTAL THICKNESS	0.13 mm	GB7125-1999
ELONGATION	≥160%	GB7753-1987
PEEL ADHESION	≥1.5N/cm	GB2792-1998
TENSILE STRENGTH	≥20N/cm	GB7753-1987
FLAMMABILITY	<=10 seconds	UL510
VOLTAGE BREAKDOWN	7Kv	GBT4850-2002
APPLICATION TEMP	≥80°C	GBT7752-1987

+ ORDERING INFORMATION

PART NUMBER	REEL LENGTH (METRES)	TAPE WIDTH (mm)
ITR1 *	20	19
ITR2 *	33	19

* specify colour when ordering: Black, Red, Yellow, Blue, Green, White, Grey, Brown and Earth (Green/Yellow)

TERMINAL BLOCKS

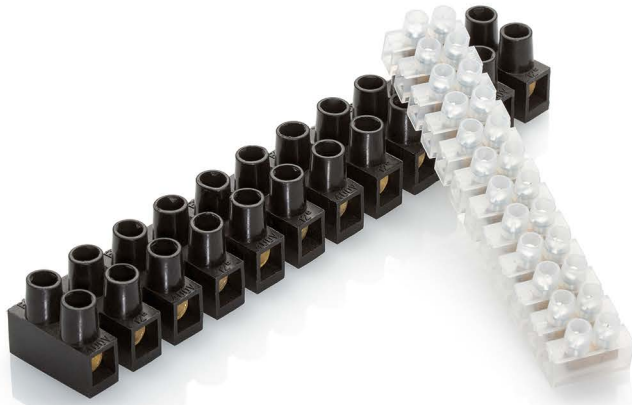

INFORMATION

- + A simple and cost effective method for connecting cables
- + Durable and flexible Polyethylene insulation
- + Twelve pole strip connector, which can easily be cut to required size
- + Available in a range of sizes



PROPERTIES

Maximum Temperature
80°C

Material
Block: Polyethylene (PE)
Inserts: Brass
Captive Screws: Galvanised Steel

Packaging
Packs of 10 or 100

Available Colours
Black and Natural



DIMENSIONS

PART NUMBER	MAX CABLE SIZE		RATED VOLTAGE	DIMENSIONS (mm)		
	SOLID	STRANDED		L	W	H
TB POLY 3	4 mm ²	2.5 mm ²	380 V	93	17	14
TB POLY 5	6 mm ²	4 mm ²	380 V	114	19	16
TB POLY 15	10 mm ²	6 mm ²	400 V	138	23	19
TB POLY 30	16 mm ²	10 mm ²	400 V	165	26	20
TB POLY 60	25 mm ²	16 mm ²	400V	186	30	26

Available in either Black or Natural, specify when ordering

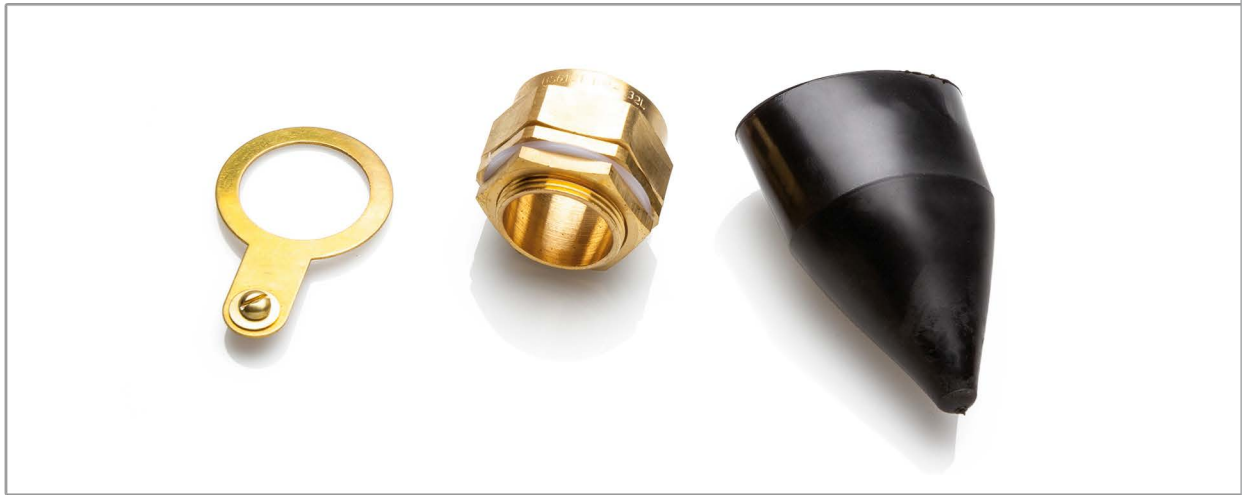

+ INFORMATION

- + High quality brass armoured cable gland kit
- + Complete with brass locknut, PVC shroud, and earth tag with screw
- + Suitable for indoor use

+ PROPERTIES

Conforms to
To IEC (EN) 62444 : 2010, BS6121:Part 1:1989 IP3X for Indoor use

+ DIMENSIONS

PART NUMBER	FIXING HOLE SIZE	THREAD LENGTH (mm)	CABLE DIAMETER (mm)	PACK QUANTITY
PXBW-20S	M20	10,0	11.8 to 15.8	1
PXBW-20L	M20	10,0	14.0 to 20.8	1
PXBW-25S	M25	10,0	18.0 to 24.0	1
PXBW-25L	M25	10,0	20.0 to 27.2	1
PXBW-32S	M32	10,0	24.5 to 31.0	1
PXBW-32L	M32	10,0	26.3 to 33.5	1
PXBW-40S	M40	15,0	30.4 to 38.5	1
PXBW-40L	M40	15,0	32.2 to 40.0	1
PXBW-50S	M50	15,0	38.2 to 46.3	1
PXBW-50L	M50	15,0	44.0 to 52.6	1
PXBW-63S	M63	15,0	50.0 to 59.0	1
PXBW-63L	M63	15,0	56.0 to 65.3	1
PXBW-75S	M75	15,0	62.0 to 71.6	1
PXBW-75L	M75	15,0	68.0 to 78.0	1

Each kit contains one complete gland.

CW OUTDOOR GLAND KITS



+ INFORMATION

- + High quality brass armoured cable gland kit
- + Complete with brass locknut, PVC shroud, and earth tag with screw
- + Suitable for outdoor use

+ PROPERTIES

Conforms to

To IEC (EN) 62444 : 2010, BS6121:Part 1:1989 IP66 for Outdoor use

+ DIMENSIONS

PART NUMBER	FIXING HOLE SIZE	THREAD LENGTH (mm)	CABLE DIAMETER (mm)	PACK QUANTITY
PXCW-20S	M20	10,0	11.8 to 15.8	1
PXCW-20L	M20	10,0	14.0 to 20.8	1
PXCW-25S	M25	10,0	18.0 to 24.0	1
PXCW-25L	M25	10,0	20.0 to 27.2	1
PXCW-32S	M32	10,0	24.5 to 31.0	1
PXCW-32L	M32	10,0	26.3 to 33.5	1
PXCW-40S	M40	15,0	30.4 to 38.5	1
PXCW-40L	M40	15,0	32.2 to 40.0	1
PXCW-50S	M50	15,0	38.2 to 46.3	1
PXCW-50L	M50	15,0	44.0 to 52.6	1
PXCW-63S	M63	15,0	50.0 to 59.0	1
PXCW-63L	M63	15,0	56.0 to 65.3	1
PXCW-75S	M75	15,0	62.0 to 71.6	1
PXCW-75L	M75	15,0	68.0 to 78.0	1

Each kit contains one complete gland.



+ INFORMATION

- + High quality brass compression gland kit for unarmoured cables
- + Complete with brass locknut, PVC shroud, and earth tag with screw
- + Suitable for indoor & outdoor use

+ PROPERTIES

Conforms to
To IEC 62444, EN 62444, BS6121:Part 1:1989 IP66 & IP68 for Indoor & Outdoor use

+ DIMENSIONS

PART NUMBER	FIXING HOLE SIZE	THREAD LENGTH (mm)	CABLE DIAMETER (mm)	PACK QUANTITY
PXA2-20S	M20	10,0	8.0 to 11.5	1
PXA2-20L	M20	10,0	11.0 to 13.5	1
PXA2-25S	M25	10,0	13.0 to 16.5	1
PXA2-25L	M25	10,0	16.0 to 19.5	1
PXA2-32S	M32	10,0	17.5 to 22.5	1
PXA2-32L	M32	10,0	19.0 to 25.5	1
PXA2-40S	M40	15,0	23.0 to 29.0	1
PXA2-40L	M40	15,0	25.0 to 32.0	1
PXA2-50S	M50	15,0	31.5 to 37.0	1
PXA2-50L	M50	15,0	36.5 to 43.0	1
PXA2-63S	M63	15,0	42.5 to 50.0	1
PXA2-63L	M63	15,0	49.5 to 55.0	1
PXA2-75S	M75	15,0	54.5 to 61.0	1
PXA2-75L	M75	15,0	60.5 to 67.0	1

Each kit contains one complete gland.





For more information about our market leading range of identification products,
 please ask for a copy of our latest catalogue.
 email: sales@partex.co.uk



www.partex.co.uk

PARTEX MARKING SYSTEMS (UK) LTD

61-64 Station Road
Coleshill, Birmingham
B46 1JT UK
phone: +44 (0)1675 463670, Fax: +44 (0)1675 463520
email: sales@partex.co.uk