

10-ohm 0.5%, 1%, 2%, 5% tolerance thick film current sense resistor

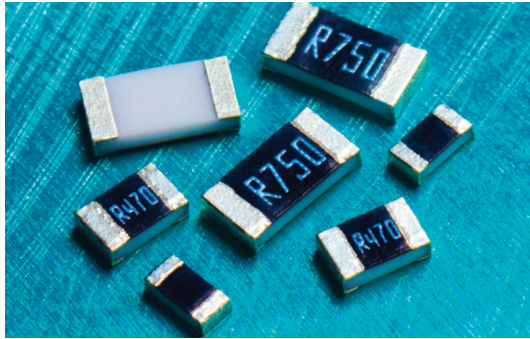

features

- Current detecting resistors for power supply, motor circuits, etc.
- High reliability and performance with resistance tolerance $\pm 0.5\%$, T.C.R. $\pm 100 \times 10^{-6} / K$
- Suitable for both reflow and flow solderings
- Products with lead-free terminations meet EU RoHS requirements. EU RoHS regulation is not intended for Pb-glass contained in electrode, resistor element and glass.
- AEC-Q200 Tested: 0402 (1E), 0603 (1J), 0805 (2A), 1206 (2B), 1210 (2E), 2010 (2H/W2H), 2512 (3A/W3A)

current sense

dimensions and construction

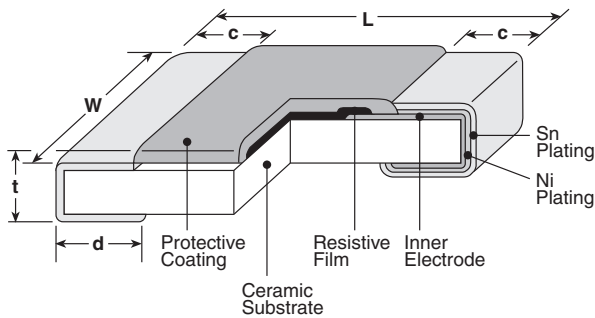

Type (Inch Size Code)	Dimensions inches (mm)				
	L	W	c	d	t
1H (0201)	.024±.001 (0.6±0.03)	.012±.001 (0.3±0.03)	.004±.002 (0.1±0.05)	.006±.002 (0.15±0.05)	.009±.001 (0.23±0.03)
1E (0402)	.039 ^{+0.004} _{-0.002} (1.0 ^{+0.1} _{-0.05})	.02 ^{+0.004} _{-0.002} (0.5 ^{+0.1} _{-0.05})	.01±.004 (0.25±0.1)	.01±.004 (0.25±0.1)	.014±.002 (0.35±0.05)
1J (0603)	.063±.008 (1.6±0.2)	.031 ^{+0.006} _{-0.004} (0.8 ^{+0.15} _{-0.1})	.014±.004 (0.35±0.1)	.014±.004 (0.35±0.1)	.018±.004 (0.45±0.1)
2A (0805)	.079±.008 (2.0±0.2)	.049±.004 (1.25±0.1)	.016±.008 (0.4±0.2)	.012 ^{+0.008} _{-0.004} (0.3 ^{+0.2} _{-0.1})	.02±.004 (0.5±0.1)
2B (1206)	.126±.008 (3.2±0.2)	.063±.008 (1.6±0.2)	.02±.012 (0.5±0.3)	.016 ^{+0.008} _{-0.004} (0.4 ^{+0.2} _{-0.1})	.024±.004 (0.6±0.1)
2E (1210)		.102±.008 (2.6±0.2)			
2H (2010)	.197±.008 (5.0±0.2)	.098±.008 (2.5±0.2)	.02±.012 (0.5±0.3)	.026±.006 (0.65±0.15)	.024±.004 (0.6±0.1)
W2H (2010)					
3A (2512)	.248±.008 (6.3±0.2)	.122±.008 (3.1±0.2)	.02±.012 (0.5±0.3)	.016 ^{+0.008} _{-0.004} (0.4 ^{+0.2} _{-0.1})	.024±.004 (0.6±0.1)
W3A (2512)				.026±.006 (0.65±0.15)	

ordering information

SR73	2B	T	TD	1R00	F
Type	Size	Termination Material	Packaging	Nominal Resistance	Tolerance
1H 1E 1J 2A 2B 2E 2H W2H 3A W3A		T: Sn G: Au ² (L: Sn/Pb) ³	TCM: 2mm pitch press paper ⁴ TPL - TP: 2mm pitch punch paper TD: 4mm pitch punch paper TE: 4mm pitch plastic embossed For further information on packaging, please refer to Appendix A	±2%, ±5%: 2 significant figures + 1 multiplier "R" indicates decimal on value <10Ω ±1%: 3 significant figures + 1 multiplier "R" indicates decimal on value <100Ω All values less than 0.1Ω (100mΩ) are expressed in mΩ with "L" as decimal Example: 20mΩ = 20L (3-digit)	D: ±0.5% F: ±1% G: ±2% J: ±5%
		² Products with gold plated electrodes are also available only 1J, 2A and 2B type (0.1Ω~10Ω, F:±1%, J:±5%), so please consult with us.			
		³ With type 1H, W2H and W3A, W3A2 only T is available as the terminal surface material.			
		⁴ Standard taping specification of 1H is TCM. Previously available. "TC (10,000pcs/Reel)" is not recommended for new designs.			

10-ohm 0.5%, 1%, 2%, 5% tolerance thick film current sense resistor

applications and ratings

current sense

Part Designation*	Power Rating	Rated Ambient Temp.	Rated Terminal Part Temp.	T.C.R. (ppm/°C) Max.	Resistance Range			
					E-24, E-96 (D±0.5%)	E-24, E-96 (F±1%)**	E-24 (G±2%)	E-24 (J±5%)
SR731H (0201)	0.1W	70°C	—	0 ~ +400	—	1Ω - 10Ω**	—	0.27Ω - 10Ω
				0 ~ +500				0.18Ω - 0.24Ω
SR731E (0402)	1/6W (.166W)	70°C	125°C	±200	—	0.51Ω - 10Ω**	0.51Ω - 10Ω	0.51Ω - 10Ω
				±300	—	0.2Ω - 0.47Ω**	0.2Ω - 0.47Ω	0.2Ω - 0.47Ω
				±500	—	0.1Ω - 0.18Ω**	0.1Ω - 0.18Ω	0.1Ω - 0.18Ω
				±1000	—	—	—	—
SR731J (0603)	1/5W (.2W)	70°C	125°C	±200	—	1.02Ω - 10Ω	1.1Ω - 10Ω	1.1Ω - 10Ω
	1/4W (.25W)	70°C	125°C	±200	—	0.1Ω - 1Ω	0.1Ω - 1Ω	0.1Ω - 1Ω
SR732A (0805)	1/3W (.33W)	70°C	125°C	±100	0.15Ω - 10Ω	0.1Ω - 10Ω	—	—
				±200	—	—	0.1Ω - 10Ω	0.1Ω - 10Ω
				±500	—	—	—	0.051Ω - 0.091Ω
				±800	—	—	—	0.030Ω - 0.047Ω
	1/2W (.5W)	70°C	105°C	±100	0.15Ω - 10Ω	0.1Ω - 10Ω	—	—
				±200	—	—	0.1Ω - 10Ω	0.1Ω - 10Ω
				±500	—	—	—	0.051Ω - 0.091Ω
				±800	—	—	—	0.030Ω - 0.047Ω
SR732B (1206)	1/3W (.33W)	70°C	125°C	±100	0.15Ω - 10Ω	0.1Ω - 10Ω	—	—
				±200	—	—	0.1Ω - 10Ω	0.1Ω - 10Ω
				±500	—	—	—	0.056Ω - 0.091Ω
				±800	—	—	—	0.030Ω - 0.051Ω
	1/2W (.5W)	70°C	110°C	±100	0.15Ω - 10Ω	0.1Ω - 10Ω	—	—
				±200	—	—	0.1Ω - 10Ω	0.1Ω - 10Ω
				±500	—	—	—	0.056Ω - 0.091Ω
				±800	—	—	—	0.030Ω - 0.051Ω
SR732E (1210)	1/2W (.5W)	70°C	125°C	±100	—	0.1Ω - 10Ω	—	—
				±200	—	—	0.1Ω - 10Ω	0.047Ω - 10Ω
				±500	—	—	—	0.036Ω - 0.043Ω
				±1000	—	—	—	0.024Ω - 0.033Ω
	2/3W (.66W)	70°C	110°C	±100	—	0.1Ω - 10Ω	—	—
				±200	—	—	0.1Ω - 10Ω	0.047Ω - 10Ω
				±500	—	—	—	0.036Ω - 0.043Ω
				±1000	—	—	—	0.024Ω - 0.033Ω
SR732H/W2H (2010)	3/4W (.75W)	70°C	125°C	±100	—	0.1Ω - 10Ω	—	—
				±200	—	—	0.1Ω - 10Ω	0.1Ω - 10Ω
				±500	—	—	—	0.056Ω - 0.091Ω
				±800	—	—	—	0.033Ω - 0.051Ω
SR733A/W3A (2512)	1W	70°C	125°C	±100	—	0.1Ω - 10Ω	—	—
				±200	—	—	0.1Ω - 10Ω	0.1Ω - 10Ω
				±500	—	—	—	0.056Ω - 0.091Ω
				±800	—	—	—	0.039Ω - 0.051Ω

* Parentheses indicate EIA package size codes. ** 1H, 1E (F: ±1%) E-24 values only. Operating Temp: -55°C to +125°C (SR731H only), -55°C to +150°C
 If any questions should arise whether to use the "Rated Ambient Temperature" or the "Rated Terminal Part Temperature," please give priority to the "Rated Terminal Part Temperature." Prior to use and for more details refer to "Introduction of the derating curves on the terminal part temperature" in the beginning of the catalog.
 † Prior to use, refer to the "Higher Power Ratings" in the beginning of catalog. Rated voltage = $\sqrt{\text{Power rating} \times \text{resistance value}}$ or max. working voltage, whichever is lower

environmental applications

Derating Curve

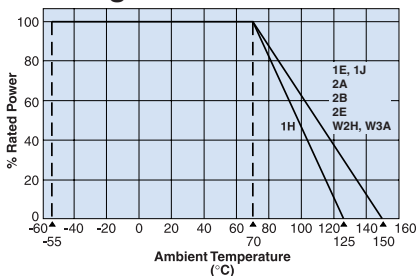

For resistors operated at an ambient temperature of 70°C or above, a power rating shall be derated in accordance with the derating curve.

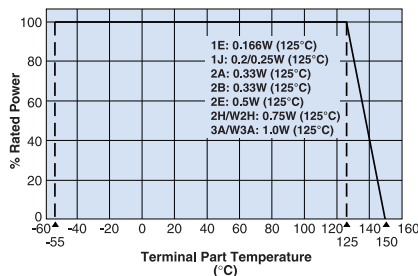

For resistors operated at a terminal part temperature of described for each size or above, a power rating shall be derated in accordance with the derating curve.

Please refer to "Introduction of the derating curve based on the terminal part temperature" on the beginning of our catalog before use.

SR73 2A (0.5W), SR73 2B (0.5W), SR73 2E (0.66W)

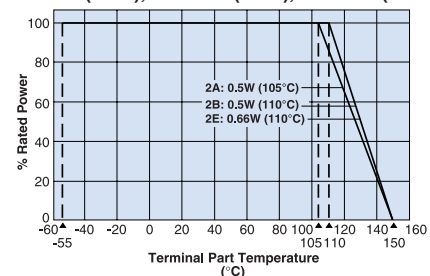

10-ohm 0.5%, 1%, 2%, 5% tolerance thick film current sense resistor

Temperature Rise

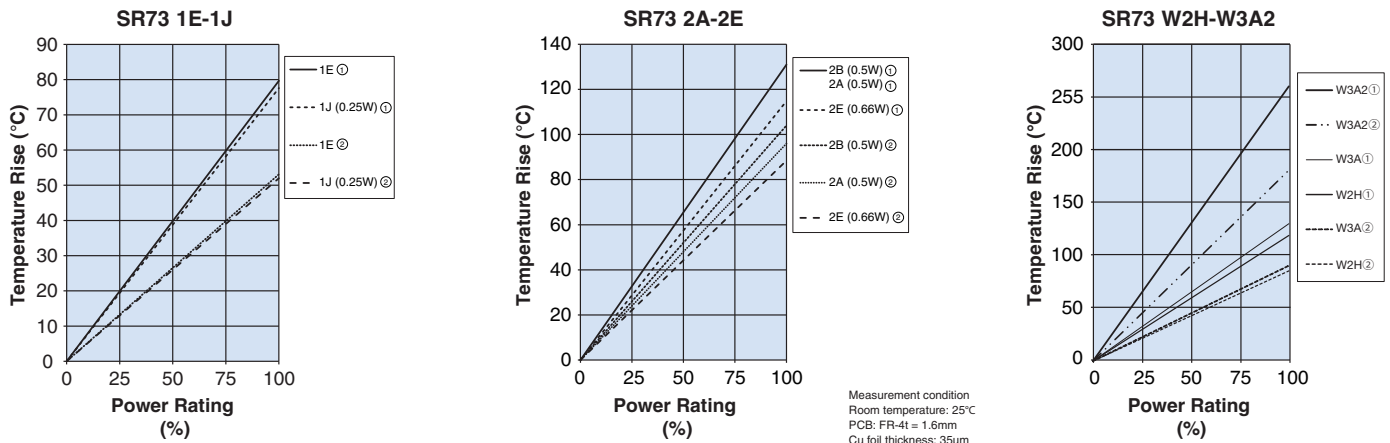

Regarding the temperature rise, the value of the temperature varies per conditions and board for use since the temperature is measured under our measuring conditions.

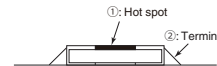

current sense

One-Pulse Limiting Electric Power

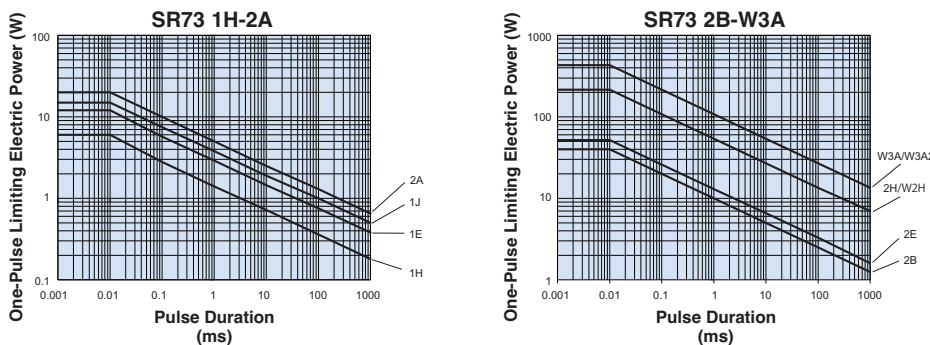

Please contact factory for resistance characteristics of continuous applied pulse.

Performance Characteristics

Parameter	Requirement $\Delta R \pm(\%+0.005\Omega)$		Test Method
	Limit	Typical	
Resistance	Within specified tolerance	—	25°C
T.C.R.	Within specified T.C.R.	—	+25°C/-55°C and +25°C/+125°C
Overload (Short time)	±2%	±0.5%	Rated voltage x 2.5 for 5 seconds
Resistance to Solder Heat	1H: ±3%, 1E~W3A: ±1%	1H: ±0.75% 1E~W3A: ±0.3%	260°C ± 5°C, 10 seconds ± 1 second
Rapid Change of Temperature	±1%	±0.3%	-40°C (30 minutes), +125°C (30 minutes), 100 cycles
Moisture Resistance	1H: ±3% 1E~W3A: ±2%	±1%	40°C ± 2°C, 90%-95% RH, 1000 hours, 1.5 hr ON, 0.5 hr OFF cycle
Endurance at 70°C	1H: ±3% 1E~W3A: ±2%	±1%	70°C ± 2°C or rated terminal part temperature ±2°C, 1000 hours, 1.5 hr ON, 0.5 hr OFF cycle
High Temperature Exposure	±1%	±0.3%	1H: +125°C, 1000 hours; 1E, 1J, 2A, 2B, 2E, 2H/W2H, 3A/W3A: +150°C, 1000 hours