



CATHODE  ANODE 



ELECTRO-OPTICAL CHARACTERISTICS $T_a=25^{\circ}\text{C}$ $I_f=20\text{mA}$					
PARAMETER	MIN	TYP	MAX	UNITS	TEST COND
PEAK WAVELENGTH		590		nm	
FORWARD VOLTAGE		2.0	2.5	Vf	$I_f=100\mu\text{A}$
REVERSE VOLTAGE	5.0			Vr	$I_f=20\text{mA}$
AXIAL INTENSITY		250		mcd	$I_f=20\text{mA}$
VIEWING ANGLE		110		2x theta	
EMITTED COLOR:	YELLOW				
LENS FINISH:	WATER CLEAR				

LIMITS OF SAFE OPERATION AT 25°C		
PARAMETER	MAX	UNITS
PEAK FORWARD CURRENT*	150	mA
STEADY CURRENT	30	mA
POWER DISSIPATION	75	mW
DERATE FROM 25°C	-1.2	mW/°C
OPERATING TEMP.	-40 TO +85	°C
STORAGE TEMP.	-40 TO +85	°C

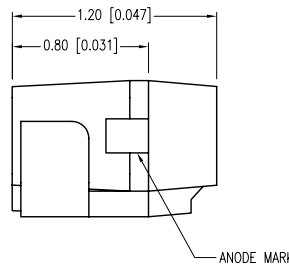
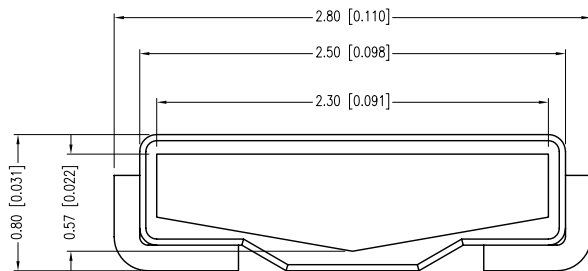
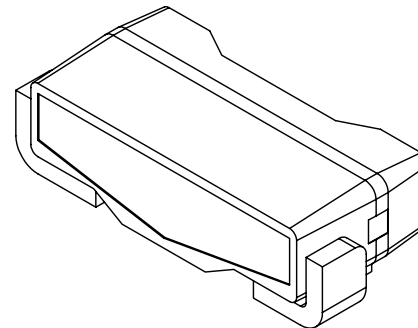
* $t < 10\mu\text{s}$

CAUTION: MOISTURE SENSITIVE DEVICE
PER JEDEC LEVEL 3 STANDARDS

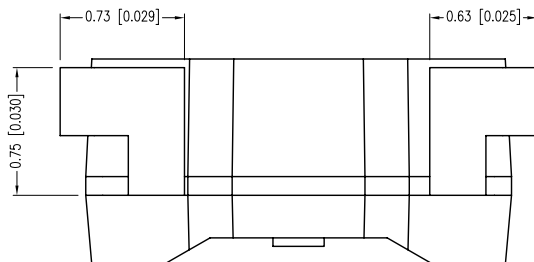

RECOMMENDED SOLDER PAD LAYOUT

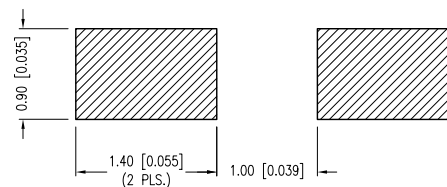

*UNLESS OTHERWISE SPECIFIED TOLERANCES PER DECIMAL PRECISION ARE: X=±1 (±0.039), X.X=±0.5 (±0.020), X.XX=±0.25 (±0.010), X.XXX=±0.127 (±0.005). LEAD SIZE=±0.05 (±0.002), LEAD LENGTH=±0.75 (±0.030). MIN= $\begin{matrix} +\text{DECIMAL PRECISION} \\ -0.00 \end{matrix}$ MAX= $\begin{matrix} +0.00 \\ -\text{DECIMAL PRECISION} \end{matrix}$



290 E. HELEN ROAD
PALATINE, IL 60067-6976
PHONE: +1.847.359.2790
FAX: +1.847.359.6538
WEB: WWW.LUMEX.COM
MEMBER OF ITW PHOTONICS GROUP

2.8 x 0.8 SMD RIGHT ANGLE LED, 590nm SUPER YELLOW, WATER CLEAR LENS, TAPE & REEL.

THE SPECIFICATIONS MAY CHANGE AT ANY TIME WITHOUT NOTICE DUE TO NEW MATERIALS OR PRODUCT IMPROVEMENT.

CONFIDENTIAL INFORMATION
THE INFORMATION CONTAINED IN THIS DOCUMENT IS THE PROPERTY OF LUMEX INC. EXCEPT AS SPECIFICALLY AUTHORIZED IN WRITING BY LUMEX INC., THE HOLDER OF THIS DOCUMENT SHALL KEEP ALL INFORMATION CONTAINED HEREIN CONFIDENTIAL AND SHALL PROTECT SAME IN WHOLE OR IN PART FROM DISCLOSURE AND DISSEMINATION TO ALL THIRD PARTIES.

DATE:	02.22.12	DRAWN BY:	AB
PAGE:	1 OF 2	CHKD BY:	KF
SCALE:	NTS	APRVD BY:	KF
UNIT:	mm [INCH]		

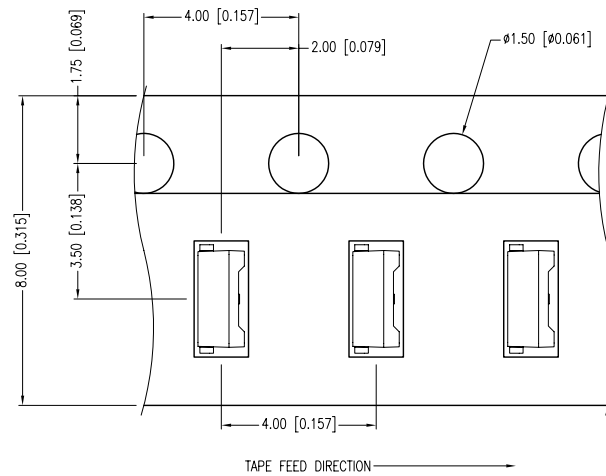
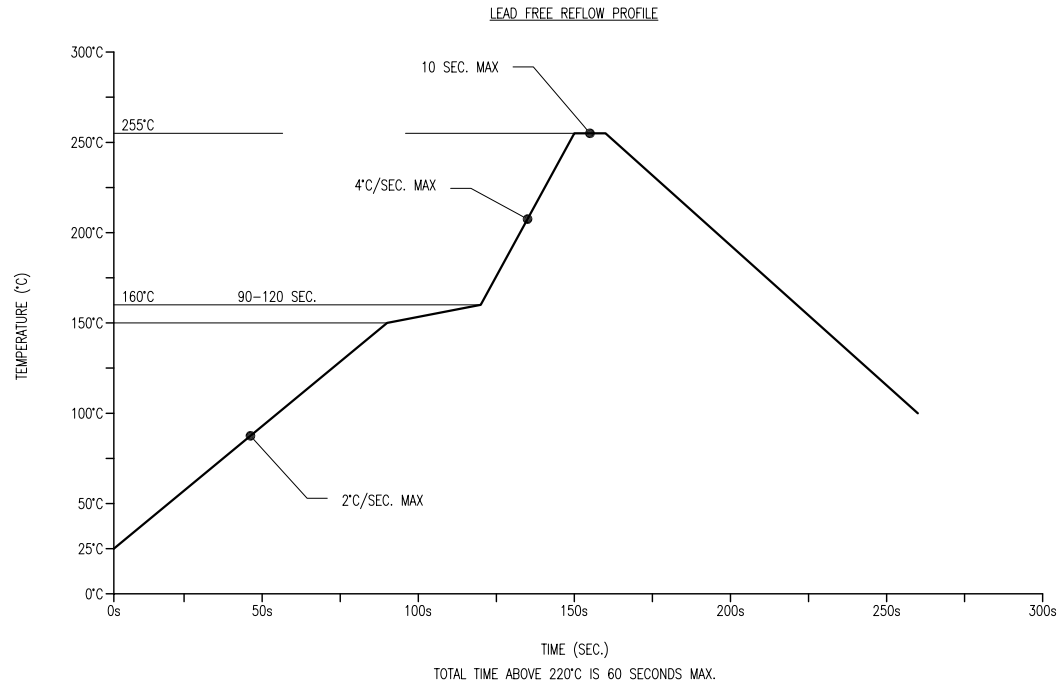

NOTES:

- 2,000 PCS/REEL
- THE CATHODE IS ORIENTED TOWARDS THE TAPE SPROCKET HOLE

*UNLESS OTHERWISE SPECIFIED TOLERANCES PER DECIMAL PRECISION ARE: X=±1 (±0.039), X.X=±0.5 (±0.020), X.XX=±0.25 (±0.010), X.XXX=±0.127 (±0.005). LEAD SIZE=±0.05 (±0.002), LEAD LENGTH=±0.75 (±0.030). MIN.= ^{+0.00}DECIMAL PRECISION _{-0.00}DECIMAL PRECISION

UNCONTROLLED DOCUMENT



290 E. HELEN ROAD
PALATINE, IL 60067-6976
PHONE: +1.847.359.2790
FAX: +1.847.359.6538
WEB: WWW.LUMEX.COM
MEMBER OF ITW PHOTONICS GROUP

2.8 x 0.8 SMD RIGHT ANGLE LED, 590nm SUPER YELLOW, WATER CLEAR LENS, TAPE & REEL.

THE SPECIFICATIONS MAY CHANGE AT ANY TIME WITHOUT NOTICE DUE TO NEW MATERIALS OR PRODUCT IMPROVEMENT.

CONFIDENTIAL INFORMATION
THE INFORMATION CONTAINED IN THIS DOCUMENT IS THE PROPERTY OF LUMEX INC. EXCEPT AS SPECIFICALLY AUTHORIZED IN WRITING BY LUMEX INC., THE HOLDER OF THIS DOCUMENT SHALL KEEP ALL INFORMATION CONTAINED HEREIN CONFIDENTIAL AND SHALL PROTECT SAME IN WHOLE OR IN PART FROM DISCLOSURE AND DISSEMINATION TO ALL THIRD PARTIES.

DATE:	02.22.12	DRAWN BY:	AB
PAGE:	2 OF 2	CHKD BY:	KF
SCALE:	NTS	APRVD BY:	KF
UNIT:	mm [INCH]		Ⓟ