

Data sheet | Item number: 2061-903

Board-to-Board Link; Pin spacing 6 mm; 3-pole; Length: 30 mm; white

www.wago.com/2061-903

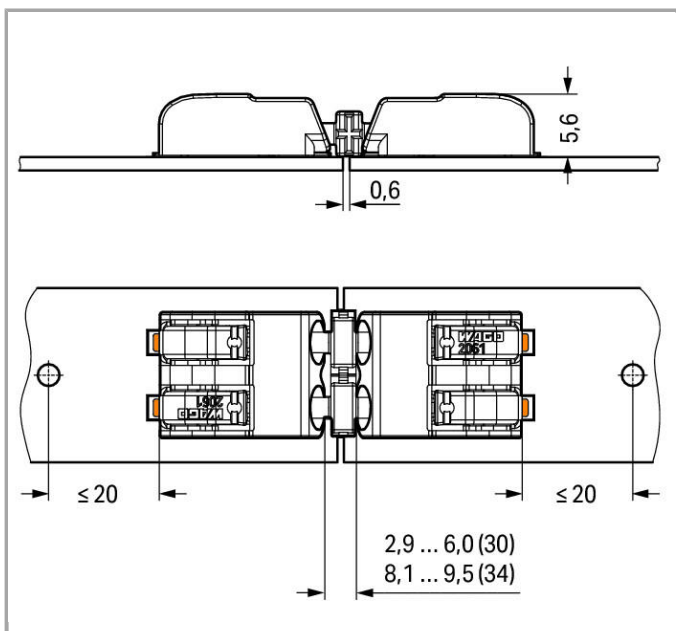
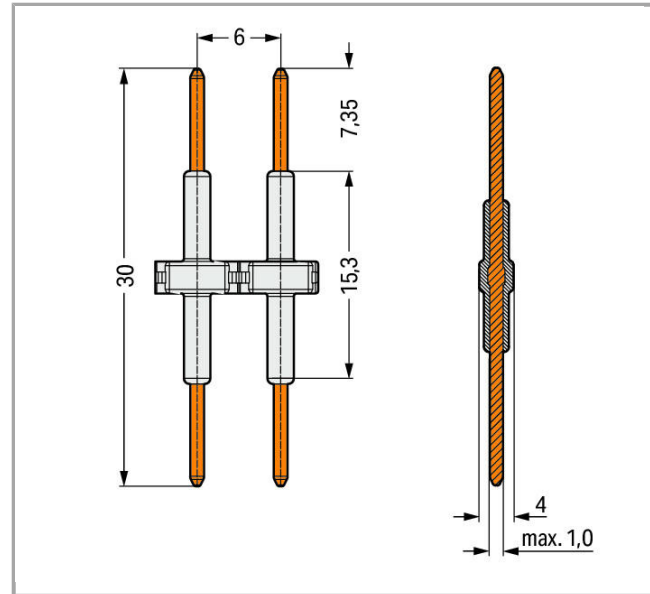
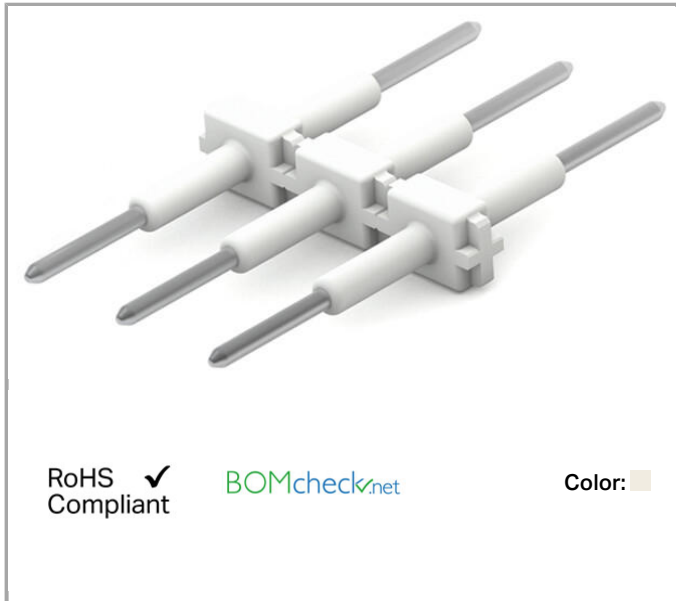

Item description

- Verbindungselement zum vereinfachten Aneinanderreihen von LED-Platinen
- Einfache Handhabung durch direktes Stecken und Trennen ohne Drückerbetätigung

Data

Electrical data

Ratings per IEC/EN 60664-1

Rated voltage (III / 3)	250 V
Rated impulse voltage (III / 3)	4 kV
Rated voltage (III / 2)	320 V
Rated impulse voltage (III / 2)	4 kV
Rated voltage (II / 2)	630 V
Rated impulse voltage (II / 2)	4 kV
Rated current	9 A

Connection data

Total number of potentials	3
Number of connection types	1
No. of poles	3

Geometrical Data

Pin spacing	6 mm / 0.236 inch
Width	17.7 mm / 0.697 inch
Height	2.5 mm / 0.098 inch
Depth	30 mm / 1.181 inch

Mechanical data

Mating cycles	10
Number of mating cycles	max. 10 mating cycles

Material Data

Color	white
Material group	I
Insulating material	Polyamide 66 (PA 66)
Flammability class per UL94	V0
Contact material	Copper alloy
Contact plating	silver-plated
Weight	0.85 g

Environmental Requirements





Limit temperature range	-60 ... +105 °C
-------------------------	-----------------

Commercial data

Country of origin	CN
GTIN	4055143656801
Customs Tariff No.	85369010000

Approvals / Certificates

Country specific Approvals

Logo	Approval	Additional Approval Text	Certificate name
	CCA DEKRA Certification B.V.	EN 60947-7-4	NTR NL-7459
	CCA DEKRA Certification B.V.	EN 60838	NTR NL-7721
	KEMA/KEUR DEKRA Certification B.V.	EN 60947-7-4	71-100855
	KEMA/KEUR DEKRA Certification B.V.	EN 60838	71-106232

UL-Approvals

Logo	Approval	Additional Approval Text	Certificate name
	cURus Underwriters Laboratories Inc.	UL 1059	E45172

Downloads

Documentation

Additional Information

Technical explanations	Apr 3, 2019	pdf 3.6 MB	Download
------------------------	-------------	---------------	----------

CAD/CAE-Data

CAD data



3D Download 2061-903

URL

Download

Subject to changes.

WAGO Kontakttechnik GmbH & Co. KG
Hansastr. 27
32423 Minden
Phone: +49571 887-0 | Fax: +49571 887-169
Email: info.de@wago.com | Web: www.wago.com

Do you have any questions about our products?
We are always happy to take your call at +49 (571) 887-44222.