

Reference Specification

Leaded MLCC for Automotive with AEC-Q200
RCE Series

Product specifications in this catalog are as of Mar. 2022, and are subject to change or obsolescence without notice.
Please consult the approval sheet before ordering. Please read rating and Cautions first.

⚠ CAUTION**1. OPERATING VOLTAGE**

When DC-rated capacitors are to be used in AC or ripple current circuits, be sure to maintain the V_{p-p} value of the applied voltage or the V_{o-p} which contains DC bias within the rated voltage range. When the voltage is started to apply to the circuit or it is stopped applying, the irregular voltage may be generated for a transit period because of resonance or switching. Be sure to use a capacitor within rated voltage containing these irregular voltage.

When DC-rated capacitors are to be used in input circuits from commercial power source (AC filter), be sure to use Safety Recognized Capacitors because various regulations on withstand voltage or impulse withstand established for each equipment should be taken into considerations.

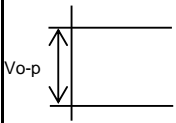
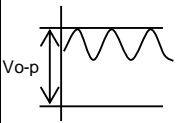
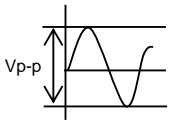
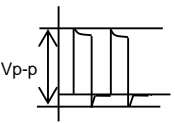
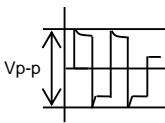
Voltage	DC Voltage	DC+AC Voltage	AC Voltage	Pulse Voltage(1)	Pulse Voltage(2)
Positional Measurement					

2. OPERATING TEMPERATURE AND SELF-GENERATED HEAT

Keep the surface temperature of a capacitor below the upper limit of its rated operating temperature range. Be sure to take into account the heat generated by the capacitor itself.

When the capacitor is used in a high-frequency current, pulse current or the like, it may have the self-generated heat due to dielectric-loss. In case of Class 2 capacitors (Temp.Char. : X7R,X7S,X8L, etc.), applied voltage should be the load such as self-generated heat is within 20 °C on the condition of atmosphere temperature 25 °C. Please contact us if self-generated heat is occurred with Class 1 capacitors (Temp.Char. : C0G,U2J,X8G, etc.). When measuring, use a thermocouple of small thermal capacity-K of $\Phi 0.1\text{mm}$ and be in the condition where capacitor is not affected by radiant heat of other components and wind of surroundings. Excessive heat may lead to deterioration of the capacitor's characteristics and reliability.

3. FAIL-SAFE

Be sure to provide an appropriate fail-safe function on your product to prevent a second damage that may be caused by the abnormal function or the failure of our product.

4. OPERATING AND STORAGE ENVIRONMENT

The insulating coating of capacitors does not form a perfect seal; therefore, do not use or store capacitors in a corrosive atmosphere, especially where chloride gas, sulfide gas, acid, alkali, salt or the like are present. And avoid exposure to moisture. Before cleaning, bonding, or molding this product, verify that these processes do not affect product quality by testing the performance of a cleaned, bonded or molded product in the intended equipment. Store the capacitors where the temperature and relative humidity do not exceed 5 to 40 °C and 20 to 70%. Use capacitors within 6 months.

5. VIBRATION AND IMPACT

Do not expose a capacitor or its leads to excessive shock or vibration during use.

6. SOLDERING

When soldering this product to a PCB/PWB, do not exceed the solder heat resistance specification of the capacitor. Subjecting this product to excessive heating could melt the internal junction solder and may result in thermal shocks that can crack the ceramic element.

7. BONDING AND RESIN MOLDING, RESIN COAT

In case of bonding, molding or coating this product, verify that these processes do not affect the quality of capacitor by testing the performance of a bonded or molded product in the intended equipment.

In case of the amount of applications, dryness / hardening conditions of adhesives and molding resins containing organic solvents (ethyl acetate, methyl ethyl ketone, toluene, etc.) are unsuitable, the outer coating resin of a capacitor is damaged by the organic solvents and it may result, worst case, in a short circuit.

The variation in thickness of adhesive or molding resin may cause a outer coating resin cracking and/or ceramic element cracking of a capacitor in a temperature cycling.

8. TREATMENT AFTER BONDING AND RESIN MOLDING, RESIN COAT

When the outer coating is hot (over 100 °C) after soldering, it becomes soft and fragile.

So please be careful not to give it mechanical stress.

Failure to follow the above cautions may result, worst case, in a short circuit and cause fuming or partial dispersion when the product is used.

9. LIMITATION OF APPLICATIONS

Please contact us before using our products for the applications listed below which require especially high reliability for the prevention of defects which might directly cause damage to the third party's life, body or property.

1. Aircraft equipment
2. Aerospace equipment
3. Undersea equipment
4. Power plant control equipment
5. Medical equipment
6. Transportation equipment (vehicles, trains, ships, etc.)
7. Traffic signal equipment
8. Disaster prevention / crime prevention equipment
9. Data-processing equipment exerting influence on public
10. Application of similar complexity and/or reliability requirements to the applications listed in the above.

NOTICE

1. CLEANING (ULTRASONIC CLEANING)

To perform ultrasonic cleaning, observe the following conditions.

Rinse bath capacity : Output of 20 watts per liter or less.

Rinsing time : 5 min maximum.

Do not vibrate the PCB/PWB directly.

Excessive ultrasonic cleaning may lead to fatigue destruction of the lead wires.

2. SOLDERING AND MOUNTING

Insertion of the Lead Wire

- When soldering, insert the lead wire into the PCB without mechanically stressing the lead wire.
- Insert the lead wire into the PCB with a distance appropriate to the lead space.

3. CAPACITANCE CHANGE OF CAPACITORS

- Class 2 capacitors (Temp.Char. : X7R,X7S,X8L etc.)

Class 2 capacitors an aging characteristic, whereby the capacitor continually decreases its capacitance slightly if the capacitor leaves for a long time. Moreover, capacitance might change greatly depending on a surrounding temperature or an applied voltage. So, it is not likely to be able to use for the time constant circuit.

Please contact us if you need a detail information.

NOTE

1. Please make sure that your product has been evaluated in view of your specifications with our product being mounted to your product.
2. You are requested not to use our product deviating from this specification.

1. Application

This specification is applied to Leaded MLCC RCE series in accordance with AEC-Q200 requirements used for Automotive Electronic equipment.

2. Rating

• Part Number Configuration

ex.)	<u>RCE</u>	<u>5C</u>	<u>2E</u>	<u>100</u>	<u>J</u>	<u>1</u>	<u>K1</u>	<u>H03</u>	<u>B</u>
	Series	Temperature Characteristics	Rated Voltage	Capacitance	Capacitance Tolerance	Dimension (LxW)	Lead Style	Individual Specification	Package

• Temperature Characteristics

Code	Temp. Char.	Temp. Range	Temp.coef.	Standard Temp.	Operating Temp. Range
5C	C0G (EIA code)	-55~25°C	0+30/-72ppm/°C	25°C	-55~125°C
		25~125°C	0+/-30ppm/°C		

• Rated Voltage

Code	Rated voltage
2E	DC250V
2J	DC630V
3A	DC1000V

• Capacitance

The first two digits denote significant figures ; the last digit denotes the multiplier of 10 in pF.

ex.) In case of 102

$$10 \times 10^2 = 1000 \text{pF}$$

• Capacitance Tolerance

Code	Capacitance Tolerance
J	+/-5%

• Dimension (LxW)

Please refer to [Part number list].

• Lead Style

*Lead wire is "solder coated CP wire".

Code	Lead Style	Lead spacing (mm)
K1	Inside crimp type	5.0+/-0.8
M1	Inside crimp taping type	5.0+0.6/-0.2

• Individual Specification

Murata's control code.

Please refer to [Part number list].



• Package

Code	Package
A	Taping type of Ammo
B	Bulk type

3. Marking

Temp. char. : Letter code : A (C0G Char.)
 Capacitance : Actual numbers (Less than 100pF)
 3 digit numbers (100pF and over)
 Capacitance tolerance : Code
 Rated voltage : Letter code : 4 (DC250V. Except dimension code : 1)
 Letter code : 7 (DC630V. Except dimension code : 1)
 Letter code : A (DC1000V.)
 Company name code : Abbreviation :  (Except dimension code : 1)

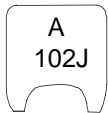
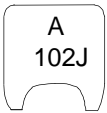
(Ex.)

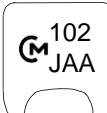
Rated voltage Dimension code	DC250V	DC630V	DC1000V
1			—
2			

4. Part number list

- Inside Crimp
(Lead Style:K*)

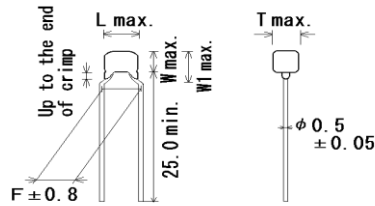

Unit : mm

Customer Part Number	Murata Part Number	T.C.	DC Rated Volt. (V)	Cap.	Cap. Tol.	Dimension (mm)					Dimension (LxW) Lead Style	Pack qty. (pcs)
						L	W	W1	F	T		
	RCE5C2E100J1K1H03B	C0G	250	10pF	±5%	4.0	3.5	5.0	5.0	3.15	1K1	500
	RCE5C2E100J2K1H03B	C0G	250	10pF	±5%	5.5	4.0	6.0	5.0	3.15	2K1	500
	RCE5C2E120J1K1H03B	C0G	250	12pF	±5%	4.0	3.5	5.0	5.0	3.15	1K1	500
	RCE5C2E120J2K1H03B	C0G	250	12pF	±5%	5.5	4.0	6.0	5.0	3.15	2K1	500
	RCE5C2E150J1K1H03B	C0G	250	15pF	±5%	4.0	3.5	5.0	5.0	3.15	1K1	500
	RCE5C2E150J2K1H03B	C0G	250	15pF	±5%	5.5	4.0	6.0	5.0	3.15	2K1	500
	RCE5C2E180J1K1H03B	C0G	250	18pF	±5%	4.0	3.5	5.0	5.0	3.15	1K1	500
	RCE5C2E180J2K1H03B	C0G	250	18pF	±5%	5.5	4.0	6.0	5.0	3.15	2K1	500
	RCE5C2E220J1K1H03B	C0G	250	22pF	±5%	4.0	3.5	5.0	5.0	3.15	1K1	500
	RCE5C2E220J2K1H03B	C0G	250	22pF	±5%	5.5	4.0	6.0	5.0	3.15	2K1	500
	RCE5C2E270J1K1H03B	C0G	250	27pF	±5%	4.0	3.5	5.0	5.0	3.15	1K1	500
	RCE5C2E270J2K1H03B	C0G	250	27pF	±5%	5.5	4.0	6.0	5.0	3.15	2K1	500
	RCE5C2E330J1K1H03B	C0G	250	33pF	±5%	4.0	3.5	5.0	5.0	3.15	1K1	500
	RCE5C2E330J2K1H03B	C0G	250	33pF	±5%	5.5	4.0	6.0	5.0	3.15	2K1	500
	RCE5C2E390J1K1H03B	C0G	250	39pF	±5%	4.0	3.5	5.0	5.0	3.15	1K1	500
	RCE5C2E390J2K1H03B	C0G	250	39pF	±5%	5.5	4.0	6.0	5.0	3.15	2K1	500
	RCE5C2E470J1K1H03B	C0G	250	47pF	±5%	4.0	3.5	5.0	5.0	3.15	1K1	500
	RCE5C2E470J2K1H03B	C0G	250	47pF	±5%	5.5	4.0	6.0	5.0	3.15	2K1	500
	RCE5C2E560J1K1H03B	C0G	250	56pF	±5%	4.0	3.5	5.0	5.0	3.15	1K1	500
	RCE5C2E560J2K1H03B	C0G	250	56pF	±5%	5.5	4.0	6.0	5.0	3.15	2K1	500
	RCE5C2E680J1K1H03B	C0G	250	68pF	±5%	4.0	3.5	5.0	5.0	3.15	1K1	500
	RCE5C2E680J2K1H03B	C0G	250	68pF	±5%	5.5	4.0	6.0	5.0	3.15	2K1	500
	RCE5C2E820J1K1H03B	C0G	250	82pF	±5%	4.0	3.5	5.0	5.0	3.15	1K1	500
	RCE5C2E820J2K1H03B	C0G	250	82pF	±5%	5.5	4.0	6.0	5.0	3.15	2K1	500
	RCE5C2E101J1K1H03B	C0G	250	100pF	±5%	4.0	3.5	5.0	5.0	3.15	1K1	500
	RCE5C2E101J2K1H03B	C0G	250	100pF	±5%	5.5	4.0	6.0	5.0	3.15	2K1	500
	RCE5C2E121J1K1H03B	C0G	250	120pF	±5%	4.0	3.5	5.0	5.0	3.15	1K1	500
	RCE5C2E121J2K1H03B	C0G	250	120pF	±5%	5.5	4.0	6.0	5.0	3.15	2K1	500
	RCE5C2E151J1K1H03B	C0G	250	150pF	±5%	4.0	3.5	5.0	5.0	3.15	1K1	500
	RCE5C2E151J2K1H03B	C0G	250	150pF	±5%	5.5	4.0	6.0	5.0	3.15	2K1	500
	RCE5C2E181J1K1H03B	C0G	250	180pF	±5%	4.0	3.5	5.0	5.0	3.15	1K1	500
	RCE5C2E181J2K1H03B	C0G	250	180pF	±5%	5.5	4.0	6.0	5.0	3.15	2K1	500
	RCE5C2E221J1K1H03B	C0G	250	220pF	±5%	4.0	3.5	5.0	5.0	3.15	1K1	500
	RCE5C2E221J2K1H03B	C0G	250	220pF	±5%	5.5	4.0	6.0	5.0	3.15	2K1	500
	RCE5C2E271J1K1H03B	C0G	250	270pF	±5%	4.0	3.5	5.0	5.0	3.15	1K1	500
	RCE5C2E271J2K1H03B	C0G	250	270pF	±5%	5.5	4.0	6.0	5.0	3.15	2K1	500
	RCE5C2E331J1K1H03B	C0G	250	330pF	±5%	4.0	3.5	5.0	5.0	3.15	1K1	500
	RCE5C2E331J2K1H03B	C0G	250	330pF	±5%	5.5	4.0	6.0	5.0	3.15	2K1	500
	RCE5C2E391J1K1H03B	C0G	250	390pF	±5%	4.0	3.5	5.0	5.0	3.15	1K1	500
	RCE5C2E391J2K1H03B	C0G	250	390pF	±5%	5.5	4.0	6.0	5.0	3.15	2K1	500

- Inside Crimp
(Lead Style:K*)

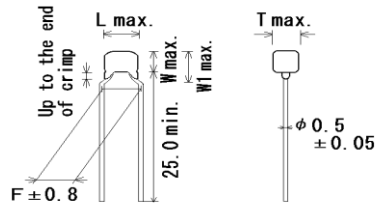

Unit : mm

Customer Part Number	Murata Part Number	T.C.	DC Rated Volt. (V)	Cap.	Cap. Tol.	Dimension (mm)					Dimension (LxW) Lead Style	Pack qty. (pcs)
						L	W	W1	F	T		
	RCE5C2E471J1K1H03B	C0G	250	470pF	±5%	4.0	3.5	5.0	5.0	3.15	1K1	500
	RCE5C2E471J2K1H03B	C0G	250	470pF	±5%	5.5	4.0	6.0	5.0	3.15	2K1	500
	RCE5C2E561J1K1H03B	C0G	250	560pF	±5%	4.0	3.5	5.0	5.0	3.15	1K1	500
	RCE5C2E561J2K1H03B	C0G	250	560pF	±5%	5.5	4.0	6.0	5.0	3.15	2K1	500
	RCE5C2E681J1K1H03B	C0G	250	680pF	±5%	4.0	3.5	5.0	5.0	3.15	1K1	500
	RCE5C2E681J2K1H03B	C0G	250	680pF	±5%	5.5	4.0	6.0	5.0	3.15	2K1	500
	RCE5C2E821J1K1H03B	C0G	250	820pF	±5%	4.0	3.5	5.0	5.0	3.15	1K1	500
	RCE5C2E821J2K1H03B	C0G	250	820pF	±5%	5.5	4.0	6.0	5.0	3.15	2K1	500
	RCE5C2E102J1K1H03B	C0G	250	1000pF	±5%	4.0	3.5	5.0	5.0	3.15	1K1	500
	RCE5C2E102J2K1H03B	C0G	250	1000pF	±5%	5.5	4.0	6.0	5.0	3.15	2K1	500
	RCE5C2E122J1K1H03B	C0G	250	1200pF	±5%	4.0	3.5	5.0	5.0	3.15	1K1	500
	RCE5C2E122J2K1H03B	C0G	250	1200pF	±5%	5.5	4.0	6.0	5.0	3.15	2K1	500
	RCE5C2E152J1K1H03B	C0G	250	1500pF	±5%	4.0	3.5	5.0	5.0	3.15	1K1	500
	RCE5C2E152J2K1H03B	C0G	250	1500pF	±5%	5.5	4.0	6.0	5.0	3.15	2K1	500
	RCE5C2E182J1K1H03B	C0G	250	1800pF	±5%	4.0	3.5	5.0	5.0	3.15	1K1	500
	RCE5C2E182J2K1H03B	C0G	250	1800pF	±5%	5.5	4.0	6.0	5.0	3.15	2K1	500
	RCE5C2E222J1K1H03B	C0G	250	2200pF	±5%	4.0	3.5	5.0	5.0	3.15	1K1	500
	RCE5C2E222J2K1H03B	C0G	250	2200pF	±5%	5.5	4.0	6.0	5.0	3.15	2K1	500
	RCE5C2E272J1K1H03B	C0G	250	2700pF	±5%	4.0	3.5	5.0	5.0	3.15	1K1	500
	RCE5C2E272J2K1H03B	C0G	250	2700pF	±5%	5.5	4.0	6.0	5.0	3.15	2K1	500
	RCE5C2E332J1K1H03B	C0G	250	3300pF	±5%	4.0	3.5	5.0	5.0	3.15	1K1	500
	RCE5C2E332J2K1H03B	C0G	250	3300pF	±5%	5.5	4.0	6.0	5.0	3.15	2K1	500
	RCE5C2E392J1K1H03B	C0G	250	3900pF	±5%	4.0	3.5	5.0	5.0	3.15	1K1	500
	RCE5C2E392J2K1H03B	C0G	250	3900pF	±5%	5.5	4.0	6.0	5.0	3.15	2K1	500
	RCE5C2E472J1K1H03B	C0G	250	4700pF	±5%	4.0	3.5	5.0	5.0	3.15	1K1	500
	RCE5C2E472J2K1H03B	C0G	250	4700pF	±5%	5.5	4.0	6.0	5.0	3.15	2K1	500
	RCE5C2E562J1K1H03B	C0G	250	5600pF	±5%	4.0	3.5	5.0	5.0	3.15	1K1	500
	RCE5C2E562J2K1H03B	C0G	250	5600pF	±5%	5.5	4.0	6.0	5.0	3.15	2K1	500
	RCE5C2E682J1K1H03B	C0G	250	6800pF	±5%	4.0	3.5	5.0	5.0	3.15	1K1	500
	RCE5C2E682J2K1H03B	C0G	250	6800pF	±5%	5.5	4.0	6.0	5.0	3.15	2K1	500
	RCE5C2E822J1K1H03B	C0G	250	8200pF	±5%	4.0	3.5	5.0	5.0	3.15	1K1	500
	RCE5C2E822J2K1H03B	C0G	250	8200pF	±5%	5.5	4.0	6.0	5.0	3.15	2K1	500
	RCE5C2E103J1K1H03B	C0G	250	10000pF	±5%	4.0	3.5	5.0	5.0	3.15	1K1	500
	RCE5C2E103J2K1H03B	C0G	250	10000pF	±5%	5.5	4.0	6.0	5.0	3.15	2K1	500
	RCE5C2E123J2K1H03B	C0G	250	12000pF	±5%	5.5	4.0	6.0	5.0	3.15	2K1	500
	RCE5C2E153J2K1H03B	C0G	250	15000pF	±5%	5.5	4.0	6.0	5.0	3.15	2K1	500
	RCE5C2E183J2K1H03B	C0G	250	18000pF	±5%	5.5	4.0	6.0	5.0	3.15	2K1	500
	RCE5C2E223J2K1H03B	C0G	250	22000pF	±5%	5.5	4.0	6.0	5.0	3.15	2K1	500
	RCE5C2J100J1K1H03B	C0G	630	10pF	±5%	4.0	3.5	5.0	5.0	3.15	1K1	500
	RCE5C2J100J2K1H03B	C0G	630	10pF	±5%	5.5	4.0	6.0	5.0	3.15	2K1	500

- Inside Crimp
(Lead Style:K*)

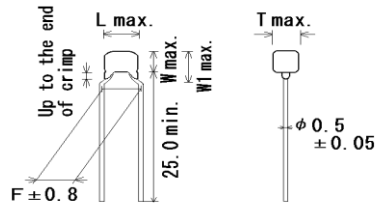

Unit : mm

Customer Part Number	Murata Part Number	T.C.	DC Rated Volt. (V)	Cap.	Cap. Tol.	Dimension (mm)					Dimension (LxW) Lead Style	Pack qty. (pcs)
						L	W	W1	F	T		
	RCE5C2J120J1K1H03B	C0G	630	12pF	±5%	4.0	3.5	5.0	5.0	3.15	1K1	500
	RCE5C2J120J2K1H03B	C0G	630	12pF	±5%	5.5	4.0	6.0	5.0	3.15	2K1	500
	RCE5C2J150J1K1H03B	C0G	630	15pF	±5%	4.0	3.5	5.0	5.0	3.15	1K1	500
	RCE5C2J150J2K1H03B	C0G	630	15pF	±5%	5.5	4.0	6.0	5.0	3.15	2K1	500
	RCE5C2J180J1K1H03B	C0G	630	18pF	±5%	4.0	3.5	5.0	5.0	3.15	1K1	500
	RCE5C2J180J2K1H03B	C0G	630	18pF	±5%	5.5	4.0	6.0	5.0	3.15	2K1	500
	RCE5C2J220J1K1H03B	C0G	630	22pF	±5%	4.0	3.5	5.0	5.0	3.15	1K1	500
	RCE5C2J220J2K1H03B	C0G	630	22pF	±5%	5.5	4.0	6.0	5.0	3.15	2K1	500
	RCE5C2J270J1K1H03B	C0G	630	27pF	±5%	4.0	3.5	5.0	5.0	3.15	1K1	500
	RCE5C2J270J2K1H03B	C0G	630	27pF	±5%	5.5	4.0	6.0	5.0	3.15	2K1	500
	RCE5C2J330J1K1H03B	C0G	630	33pF	±5%	4.0	3.5	5.0	5.0	3.15	1K1	500
	RCE5C2J330J2K1H03B	C0G	630	33pF	±5%	5.5	4.0	6.0	5.0	3.15	2K1	500
	RCE5C2J390J1K1H03B	C0G	630	39pF	±5%	4.0	3.5	5.0	5.0	3.15	1K1	500
	RCE5C2J390J2K1H03B	C0G	630	39pF	±5%	5.5	4.0	6.0	5.0	3.15	2K1	500
	RCE5C2J470J1K1H03B	C0G	630	47pF	±5%	4.0	3.5	5.0	5.0	3.15	1K1	500
	RCE5C2J470J2K1H03B	C0G	630	47pF	±5%	5.5	4.0	6.0	5.0	3.15	2K1	500
	RCE5C2J560J1K1H03B	C0G	630	56pF	±5%	4.0	3.5	5.0	5.0	3.15	1K1	500
	RCE5C2J560J2K1H03B	C0G	630	56pF	±5%	5.5	4.0	6.0	5.0	3.15	2K1	500
	RCE5C2J680J1K1H03B	C0G	630	68pF	±5%	4.0	3.5	5.0	5.0	3.15	1K1	500
	RCE5C2J680J2K1H03B	C0G	630	68pF	±5%	5.5	4.0	6.0	5.0	3.15	2K1	500
	RCE5C2J820J1K1H03B	C0G	630	82pF	±5%	4.0	3.5	5.0	5.0	3.15	1K1	500
	RCE5C2J820J2K1H03B	C0G	630	82pF	±5%	5.5	4.0	6.0	5.0	3.15	2K1	500
	RCE5C2J101J1K1H03B	C0G	630	100pF	±5%	4.0	3.5	5.0	5.0	3.15	1K1	500
	RCE5C2J101J2K1H03B	C0G	630	100pF	±5%	5.5	4.0	6.0	5.0	3.15	2K1	500
	RCE5C2J121J1K1H03B	C0G	630	120pF	±5%	4.0	3.5	5.0	5.0	3.15	1K1	500
	RCE5C2J121J2K1H03B	C0G	630	120pF	±5%	5.5	4.0	6.0	5.0	3.15	2K1	500
	RCE5C2J151J1K1H03B	C0G	630	150pF	±5%	4.0	3.5	5.0	5.0	3.15	1K1	500
	RCE5C2J151J2K1H03B	C0G	630	150pF	±5%	5.5	4.0	6.0	5.0	3.15	2K1	500
	RCE5C2J181J1K1H03B	C0G	630	180pF	±5%	4.0	3.5	5.0	5.0	3.15	1K1	500
	RCE5C2J181J2K1H03B	C0G	630	180pF	±5%	5.5	4.0	6.0	5.0	3.15	2K1	500
	RCE5C2J221J1K1H03B	C0G	630	220pF	±5%	4.0	3.5	5.0	5.0	3.15	1K1	500
	RCE5C2J221J2K1H03B	C0G	630	220pF	±5%	5.5	4.0	6.0	5.0	3.15	2K1	500
	RCE5C2J271J1K1H03B	C0G	630	270pF	±5%	4.0	3.5	5.0	5.0	3.15	1K1	500
	RCE5C2J271J2K1H03B	C0G	630	270pF	±5%	5.5	4.0	6.0	5.0	3.15	2K1	500
	RCE5C2J331J1K1H03B	C0G	630	330pF	±5%	4.0	3.5	5.0	5.0	3.15	1K1	500
	RCE5C2J331J2K1H03B	C0G	630	330pF	±5%	5.5	4.0	6.0	5.0	3.15	2K1	500
	RCE5C2J391J1K1H03B	C0G	630	390pF	±5%	4.0	3.5	5.0	5.0	3.15	1K1	500
	RCE5C2J391J2K1H03B	C0G	630	390pF	±5%	5.5	4.0	6.0	5.0	3.15	2K1	500
	RCE5C2J471J1K1H03B	C0G	630	470pF	±5%	4.0	3.5	5.0	5.0	3.15	1K1	500
	RCE5C2J471J2K1H03B	C0G	630	470pF	±5%	5.5	4.0	6.0	5.0	3.15	2K1	500

- Inside Crimp
(Lead Style:K*)

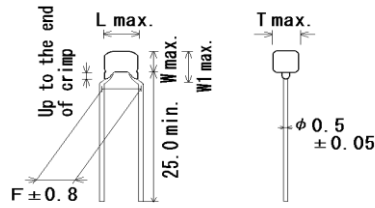

Unit : mm

Customer Part Number	Murata Part Number	T.C.	DC Rated Volt. (V)	Cap.	Cap. Tol.	Dimension (mm)					Dimension (LxW) Lead Style	Pack qty. (pcs)
						L	W	W1	F	T		
	RCE5C2J561J1K1H03B	C0G	630	560pF	±5%	4.0	3.5	5.0	5.0	3.15	1K1	500
	RCE5C2J561J2K1H03B	C0G	630	560pF	±5%	5.5	4.0	6.0	5.0	3.15	2K1	500
	RCE5C2J681J1K1H03B	C0G	630	680pF	±5%	4.0	3.5	5.0	5.0	3.15	1K1	500
	RCE5C2J681J2K1H03B	C0G	630	680pF	±5%	5.5	4.0	6.0	5.0	3.15	2K1	500
	RCE5C2J821J1K1H03B	C0G	630	820pF	±5%	4.0	3.5	5.0	5.0	3.15	1K1	500
	RCE5C2J821J2K1H03B	C0G	630	820pF	±5%	5.5	4.0	6.0	5.0	3.15	2K1	500
	RCE5C2J102J1K1H03B	C0G	630	1000pF	±5%	4.0	3.5	5.0	5.0	3.15	1K1	500
	RCE5C2J102J2K1H03B	C0G	630	1000pF	±5%	5.5	4.0	6.0	5.0	3.15	2K1	500
	RCE5C2J122J1K1H03B	C0G	630	1200pF	±5%	4.0	3.5	5.0	5.0	3.15	1K1	500
	RCE5C2J122J2K1H03B	C0G	630	1200pF	±5%	5.5	4.0	6.0	5.0	3.15	2K1	500
	RCE5C2J152J1K1H03B	C0G	630	1500pF	±5%	4.0	3.5	5.0	5.0	3.15	1K1	500
	RCE5C2J152J2K1H03B	C0G	630	1500pF	±5%	5.5	4.0	6.0	5.0	3.15	2K1	500
	RCE5C2J182J1K1H03B	C0G	630	1800pF	±5%	4.0	3.5	5.0	5.0	3.15	1K1	500
	RCE5C2J182J2K1H03B	C0G	630	1800pF	±5%	5.5	4.0	6.0	5.0	3.15	2K1	500
	RCE5C2J222J1K1H03B	C0G	630	2200pF	±5%	4.0	3.5	5.0	5.0	3.15	1K1	500
	RCE5C2J222J2K1H03B	C0G	630	2200pF	±5%	5.5	4.0	6.0	5.0	3.15	2K1	500
	RCE5C2J272J2K1H03B	C0G	630	2700pF	±5%	5.5	4.0	6.0	5.0	3.15	2K1	500
	RCE5C2J332J2K1H03B	C0G	630	3300pF	±5%	5.5	4.0	6.0	5.0	3.15	2K1	500
	RCE5C2J392J2K1H03B	C0G	630	3900pF	±5%	5.5	4.0	6.0	5.0	3.15	2K1	500
	RCE5C2J472J2K1H03B	C0G	630	4700pF	±5%	5.5	4.0	6.0	5.0	3.15	2K1	500
	RCE5C3A100J2K1H03B	C0G	1000	10pF	±5%	5.5	4.0	6.0	5.0	3.15	2K1	500
	RCE5C3A120J2K1H03B	C0G	1000	12pF	±5%	5.5	4.0	6.0	5.0	3.15	2K1	500
	RCE5C3A150J2K1H03B	C0G	1000	15pF	±5%	5.5	4.0	6.0	5.0	3.15	2K1	500
	RCE5C3A180J2K1H03B	C0G	1000	18pF	±5%	5.5	4.0	6.0	5.0	3.15	2K1	500
	RCE5C3A220J2K1H03B	C0G	1000	22pF	±5%	5.5	4.0	6.0	5.0	3.15	2K1	500
	RCE5C3A270J2K1H03B	C0G	1000	27pF	±5%	5.5	4.0	6.0	5.0	3.15	2K1	500
	RCE5C3A330J2K1H03B	C0G	1000	33pF	±5%	5.5	4.0	6.0	5.0	3.15	2K1	500
	RCE5C3A390J2K1H03B	C0G	1000	39pF	±5%	5.5	4.0	6.0	5.0	3.15	2K1	500
	RCE5C3A470J2K1H03B	C0G	1000	47pF	±5%	5.5	4.0	6.0	5.0	3.15	2K1	500
	RCE5C3A560J2K1H03B	C0G	1000	56pF	±5%	5.5	4.0	6.0	5.0	3.15	2K1	500
	RCE5C3A680J2K1H03B	C0G	1000	68pF	±5%	5.5	4.0	6.0	5.0	3.15	2K1	500
	RCE5C3A820J2K1H03B	C0G	1000	82pF	±5%	5.5	4.0	6.0	5.0	3.15	2K1	500
	RCE5C3A101J2K1H03B	C0G	1000	100pF	±5%	5.5	4.0	6.0	5.0	3.15	2K1	500
	RCE5C3A121J2K1H03B	C0G	1000	120pF	±5%	5.5	4.0	6.0	5.0	3.15	2K1	500
	RCE5C3A151J2K1H03B	C0G	1000	150pF	±5%	5.5	4.0	6.0	5.0	3.15	2K1	500
	RCE5C3A181J2K1H03B	C0G	1000	180pF	±5%	5.5	4.0	6.0	5.0	3.15	2K1	500
	RCE5C3A221J2K1H03B	C0G	1000	220pF	±5%	5.5	4.0	6.0	5.0	3.15	2K1	500
	RCE5C3A271J2K1H03B	C0G	1000	270pF	±5%	5.5	4.0	6.0	5.0	3.15	2K1	500
	RCE5C3A331J2K1H03B	C0G	1000	330pF	±5%	5.5	4.0	6.0	5.0	3.15	2K1	500
	RCE5C3A391J2K1H03B	C0G	1000	390pF	±5%	5.5	4.0	6.0	5.0	3.15	2K1	500

- Inside Crimp
(Lead Style:K*)

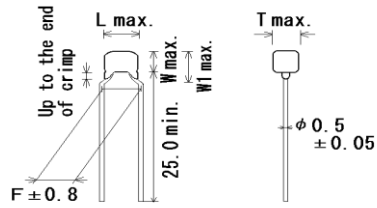

Unit : mm

Customer Part Number	Murata Part Number	T.C.	DC Rated Volt. (V)	Cap.	Cap. Tol.	Dimension (mm)					Dimension (LxW) Lead Style	Pack qty. (pcs)
						L	W	W1	F	T		
	RCE5C3A471J2K1H03B	C0G	1000	470pF	±5%	5.5	4.0	6.0	5.0	3.15	2K1	500
	RCE5C3A561J2K1H03B	C0G	1000	560pF	±5%	5.5	4.0	6.0	5.0	3.15	2K1	500
	RCE5C3A681J2K1H03B	C0G	1000	680pF	±5%	5.5	4.0	6.0	5.0	3.15	2K1	500
	RCE5C3A821J2K1H03B	C0G	1000	820pF	±5%	5.5	4.0	6.0	5.0	3.15	2K1	500
	RCE5C3A102J2K1H03B	C0G	1000	1000pF	±5%	5.5	4.0	6.0	5.0	3.15	2K1	500

• Inside Crimp Taping
(Lead Style: M*)

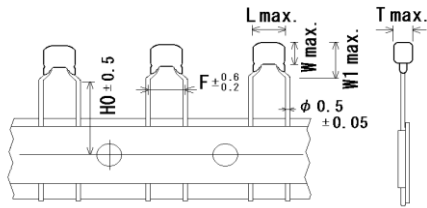

Unit : mm

Customer Part Number	Murata Part Number	T.C.	DC Rated Volt. (V)	Cap.	Cap. Tol.	Dimension (mm)						Dimension (LxW) Lead Style	Pack qty. (pcs)
						L	W	W1	F	T	H/HO		
	RCE5C2E100J1M1H03A	C0G	250	10pF	±5%	4.0	3.5	5.0	5.0	3.15	16.0	1M1	2000
	RCE5C2E100J2M1H03A	C0G	250	10pF	±5%	5.5	4.0	6.0	5.0	3.15	16.0	2M1	2000
	RCE5C2E120J1M1H03A	C0G	250	12pF	±5%	4.0	3.5	5.0	5.0	3.15	16.0	1M1	2000
	RCE5C2E120J2M1H03A	C0G	250	12pF	±5%	5.5	4.0	6.0	5.0	3.15	16.0	2M1	2000
	RCE5C2E150J1M1H03A	C0G	250	15pF	±5%	4.0	3.5	5.0	5.0	3.15	16.0	1M1	2000
	RCE5C2E150J2M1H03A	C0G	250	15pF	±5%	5.5	4.0	6.0	5.0	3.15	16.0	2M1	2000
	RCE5C2E180J1M1H03A	C0G	250	18pF	±5%	4.0	3.5	5.0	5.0	3.15	16.0	1M1	2000
	RCE5C2E180J2M1H03A	C0G	250	18pF	±5%	5.5	4.0	6.0	5.0	3.15	16.0	2M1	2000
	RCE5C2E220J1M1H03A	C0G	250	22pF	±5%	4.0	3.5	5.0	5.0	3.15	16.0	1M1	2000
	RCE5C2E220J2M1H03A	C0G	250	22pF	±5%	5.5	4.0	6.0	5.0	3.15	16.0	2M1	2000
	RCE5C2E270J1M1H03A	C0G	250	27pF	±5%	4.0	3.5	5.0	5.0	3.15	16.0	1M1	2000
	RCE5C2E270J2M1H03A	C0G	250	27pF	±5%	5.5	4.0	6.0	5.0	3.15	16.0	2M1	2000
	RCE5C2E330J1M1H03A	C0G	250	33pF	±5%	4.0	3.5	5.0	5.0	3.15	16.0	1M1	2000
	RCE5C2E330J2M1H03A	C0G	250	33pF	±5%	5.5	4.0	6.0	5.0	3.15	16.0	2M1	2000
	RCE5C2E390J1M1H03A	C0G	250	39pF	±5%	4.0	3.5	5.0	5.0	3.15	16.0	1M1	2000
	RCE5C2E390J2M1H03A	C0G	250	39pF	±5%	5.5	4.0	6.0	5.0	3.15	16.0	2M1	2000
	RCE5C2E470J1M1H03A	C0G	250	47pF	±5%	4.0	3.5	5.0	5.0	3.15	16.0	1M1	2000
	RCE5C2E470J2M1H03A	C0G	250	47pF	±5%	5.5	4.0	6.0	5.0	3.15	16.0	2M1	2000
	RCE5C2E560J1M1H03A	C0G	250	56pF	±5%	4.0	3.5	5.0	5.0	3.15	16.0	1M1	2000
	RCE5C2E560J2M1H03A	C0G	250	56pF	±5%	5.5	4.0	6.0	5.0	3.15	16.0	2M1	2000
	RCE5C2E680J1M1H03A	C0G	250	68pF	±5%	4.0	3.5	5.0	5.0	3.15	16.0	1M1	2000
	RCE5C2E680J2M1H03A	C0G	250	68pF	±5%	5.5	4.0	6.0	5.0	3.15	16.0	2M1	2000
	RCE5C2E820J1M1H03A	C0G	250	82pF	±5%	4.0	3.5	5.0	5.0	3.15	16.0	1M1	2000
	RCE5C2E820J2M1H03A	C0G	250	82pF	±5%	5.5	4.0	6.0	5.0	3.15	16.0	2M1	2000
	RCE5C2E101J1M1H03A	C0G	250	100pF	±5%	4.0	3.5	5.0	5.0	3.15	16.0	1M1	2000
	RCE5C2E101J2M1H03A	C0G	250	100pF	±5%	5.5	4.0	6.0	5.0	3.15	16.0	2M1	2000
	RCE5C2E121J1M1H03A	C0G	250	120pF	±5%	4.0	3.5	5.0	5.0	3.15	16.0	1M1	2000
	RCE5C2E121J2M1H03A	C0G	250	120pF	±5%	5.5	4.0	6.0	5.0	3.15	16.0	2M1	2000
	RCE5C2E151J1M1H03A	C0G	250	150pF	±5%	4.0	3.5	5.0	5.0	3.15	16.0	1M1	2000
	RCE5C2E151J2M1H03A	C0G	250	150pF	±5%	5.5	4.0	6.0	5.0	3.15	16.0	2M1	2000
	RCE5C2E181J1M1H03A	C0G	250	180pF	±5%	4.0	3.5	5.0	5.0	3.15	16.0	1M1	2000
	RCE5C2E181J2M1H03A	C0G	250	180pF	±5%	5.5	4.0	6.0	5.0	3.15	16.0	2M1	2000
	RCE5C2E221J1M1H03A	C0G	250	220pF	±5%	4.0	3.5	5.0	5.0	3.15	16.0	1M1	2000
	RCE5C2E221J2M1H03A	C0G	250	220pF	±5%	5.5	4.0	6.0	5.0	3.15	16.0	2M1	2000
	RCE5C2E271J1M1H03A	C0G	250	270pF	±5%	4.0	3.5	5.0	5.0	3.15	16.0	1M1	2000
	RCE5C2E271J2M1H03A	C0G	250	270pF	±5%	5.5	4.0	6.0	5.0	3.15	16.0	2M1	2000
	RCE5C2E331J1M1H03A	C0G	250	330pF	±5%	4.0	3.5	5.0	5.0	3.15	16.0	1M1	2000
	RCE5C2E331J2M1H03A	C0G	250	330pF	±5%	5.5	4.0	6.0	5.0	3.15	16.0	2M1	2000
	RCE5C2E391J1M1H03A	C0G	250	390pF	±5%	4.0	3.5	5.0	5.0	3.15	16.0	1M1	2000
	RCE5C2E391J2M1H03A	C0G	250	390pF	±5%	5.5	4.0	6.0	5.0	3.15	16.0	2M1	2000

• Inside Crimp Taping
(Lead Style: M*)

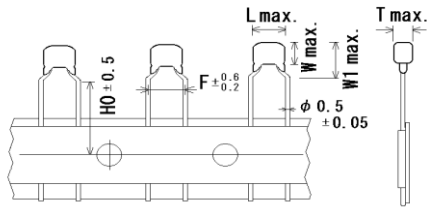

Unit : mm

Customer Part Number	Murata Part Number	T.C.	DC Rated Volt. (V)	Cap.	Cap. Tol.	Dimension (mm)						Dimension (LxW) Lead Style	Pack qty. (pcs)
						L	W	W1	F	T	H/HO		
	RCE5C2E471J1M1H03A	C0G	250	470pF	±5%	4.0	3.5	5.0	5.0	3.15	16.0	1M1	2000
	RCE5C2E471J2M1H03A	C0G	250	470pF	±5%	5.5	4.0	6.0	5.0	3.15	16.0	2M1	2000
	RCE5C2E561J1M1H03A	C0G	250	560pF	±5%	4.0	3.5	5.0	5.0	3.15	16.0	1M1	2000
	RCE5C2E561J2M1H03A	C0G	250	560pF	±5%	5.5	4.0	6.0	5.0	3.15	16.0	2M1	2000
	RCE5C2E681J1M1H03A	C0G	250	680pF	±5%	4.0	3.5	5.0	5.0	3.15	16.0	1M1	2000
	RCE5C2E681J2M1H03A	C0G	250	680pF	±5%	5.5	4.0	6.0	5.0	3.15	16.0	2M1	2000
	RCE5C2E821J1M1H03A	C0G	250	820pF	±5%	4.0	3.5	5.0	5.0	3.15	16.0	1M1	2000
	RCE5C2E821J2M1H03A	C0G	250	820pF	±5%	5.5	4.0	6.0	5.0	3.15	16.0	2M1	2000
	RCE5C2E102J1M1H03A	C0G	250	1000pF	±5%	4.0	3.5	5.0	5.0	3.15	16.0	1M1	2000
	RCE5C2E102J2M1H03A	C0G	250	1000pF	±5%	5.5	4.0	6.0	5.0	3.15	16.0	2M1	2000
	RCE5C2E122J1M1H03A	C0G	250	1200pF	±5%	4.0	3.5	5.0	5.0	3.15	16.0	1M1	2000
	RCE5C2E122J2M1H03A	C0G	250	1200pF	±5%	5.5	4.0	6.0	5.0	3.15	16.0	2M1	2000
	RCE5C2E152J1M1H03A	C0G	250	1500pF	±5%	4.0	3.5	5.0	5.0	3.15	16.0	1M1	2000
	RCE5C2E152J2M1H03A	C0G	250	1500pF	±5%	5.5	4.0	6.0	5.0	3.15	16.0	2M1	2000
	RCE5C2E182J1M1H03A	C0G	250	1800pF	±5%	4.0	3.5	5.0	5.0	3.15	16.0	1M1	2000
	RCE5C2E182J2M1H03A	C0G	250	1800pF	±5%	5.5	4.0	6.0	5.0	3.15	16.0	2M1	2000
	RCE5C2E222J1M1H03A	C0G	250	2200pF	±5%	4.0	3.5	5.0	5.0	3.15	16.0	1M1	2000
	RCE5C2E222J2M1H03A	C0G	250	2200pF	±5%	5.5	4.0	6.0	5.0	3.15	16.0	2M1	2000
	RCE5C2E272J1M1H03A	C0G	250	2700pF	±5%	4.0	3.5	5.0	5.0	3.15	16.0	1M1	2000
	RCE5C2E272J2M1H03A	C0G	250	2700pF	±5%	5.5	4.0	6.0	5.0	3.15	16.0	2M1	2000
	RCE5C2E332J1M1H03A	C0G	250	3300pF	±5%	4.0	3.5	5.0	5.0	3.15	16.0	1M1	2000
	RCE5C2E332J2M1H03A	C0G	250	3300pF	±5%	5.5	4.0	6.0	5.0	3.15	16.0	2M1	2000
	RCE5C2E392J1M1H03A	C0G	250	3900pF	±5%	4.0	3.5	5.0	5.0	3.15	16.0	1M1	2000
	RCE5C2E392J2M1H03A	C0G	250	3900pF	±5%	5.5	4.0	6.0	5.0	3.15	16.0	2M1	2000
	RCE5C2E472J1M1H03A	C0G	250	4700pF	±5%	4.0	3.5	5.0	5.0	3.15	16.0	1M1	2000
	RCE5C2E472J2M1H03A	C0G	250	4700pF	±5%	5.5	4.0	6.0	5.0	3.15	16.0	2M1	2000
	RCE5C2E562J1M1H03A	C0G	250	5600pF	±5%	4.0	3.5	5.0	5.0	3.15	16.0	1M1	2000
	RCE5C2E562J2M1H03A	C0G	250	5600pF	±5%	5.5	4.0	6.0	5.0	3.15	16.0	2M1	2000
	RCE5C2E682J1M1H03A	C0G	250	6800pF	±5%	4.0	3.5	5.0	5.0	3.15	16.0	1M1	2000
	RCE5C2E682J2M1H03A	C0G	250	6800pF	±5%	5.5	4.0	6.0	5.0	3.15	16.0	2M1	2000
	RCE5C2E822J1M1H03A	C0G	250	8200pF	±5%	4.0	3.5	5.0	5.0	3.15	16.0	1M1	2000
	RCE5C2E822J2M1H03A	C0G	250	8200pF	±5%	5.5	4.0	6.0	5.0	3.15	16.0	2M1	2000
	RCE5C2E103J1M1H03A	C0G	250	10000pF	±5%	4.0	3.5	5.0	5.0	3.15	16.0	1M1	2000
	RCE5C2E103J2M1H03A	C0G	250	10000pF	±5%	5.5	4.0	6.0	5.0	3.15	16.0	2M1	2000
	RCE5C2E123J2M1H03A	C0G	250	12000pF	±5%	5.5	4.0	6.0	5.0	3.15	16.0	2M1	2000
	RCE5C2E153J2M1H03A	C0G	250	15000pF	±5%	5.5	4.0	6.0	5.0	3.15	16.0	2M1	2000
	RCE5C2E183J2M1H03A	C0G	250	18000pF	±5%	5.5	4.0	6.0	5.0	3.15	16.0	2M1	2000
	RCE5C2E223J2M1H03A	C0G	250	22000pF	±5%	5.5	4.0	6.0	5.0	3.15	16.0	2M1	2000
	RCE5C2J100J1M1H03A	C0G	630	10pF	±5%	4.0	3.5	5.0	5.0	3.15	16.0	1M1	2000
	RCE5C2J100J2M1H03A	C0G	630	10pF	±5%	5.5	4.0	6.0	5.0	3.15	16.0	2M1	2000

• Inside Crimp Taping
(Lead Style: M*)

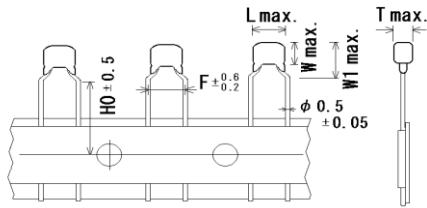

Unit : mm

Customer Part Number	Murata Part Number	T.C.	DC Rated Volt. (V)	Cap.	Cap. Tol.	Dimension (mm)						Dimension (LxW) Lead Style	Pack qty. (pcs)
						L	W	W1	F	T	H/HO		
	RCE5C2J120J1M1H03A	C0G	630	12pF	±5%	4.0	3.5	5.0	5.0	3.15	16.0	1M1	2000
	RCE5C2J120J2M1H03A	C0G	630	12pF	±5%	5.5	4.0	6.0	5.0	3.15	16.0	2M1	2000
	RCE5C2J150J1M1H03A	C0G	630	15pF	±5%	4.0	3.5	5.0	5.0	3.15	16.0	1M1	2000
	RCE5C2J150J2M1H03A	C0G	630	15pF	±5%	5.5	4.0	6.0	5.0	3.15	16.0	2M1	2000
	RCE5C2J180J1M1H03A	C0G	630	18pF	±5%	4.0	3.5	5.0	5.0	3.15	16.0	1M1	2000
	RCE5C2J180J2M1H03A	C0G	630	18pF	±5%	5.5	4.0	6.0	5.0	3.15	16.0	2M1	2000
	RCE5C2J220J1M1H03A	C0G	630	22pF	±5%	4.0	3.5	5.0	5.0	3.15	16.0	1M1	2000
	RCE5C2J220J2M1H03A	C0G	630	22pF	±5%	5.5	4.0	6.0	5.0	3.15	16.0	2M1	2000
	RCE5C2J270J1M1H03A	C0G	630	27pF	±5%	4.0	3.5	5.0	5.0	3.15	16.0	1M1	2000
	RCE5C2J270J2M1H03A	C0G	630	27pF	±5%	5.5	4.0	6.0	5.0	3.15	16.0	2M1	2000
	RCE5C2J330J1M1H03A	C0G	630	33pF	±5%	4.0	3.5	5.0	5.0	3.15	16.0	1M1	2000
	RCE5C2J330J2M1H03A	C0G	630	33pF	±5%	5.5	4.0	6.0	5.0	3.15	16.0	2M1	2000
	RCE5C2J390J1M1H03A	C0G	630	39pF	±5%	4.0	3.5	5.0	5.0	3.15	16.0	1M1	2000
	RCE5C2J390J2M1H03A	C0G	630	39pF	±5%	5.5	4.0	6.0	5.0	3.15	16.0	2M1	2000
	RCE5C2J470J1M1H03A	C0G	630	47pF	±5%	4.0	3.5	5.0	5.0	3.15	16.0	1M1	2000
	RCE5C2J470J2M1H03A	C0G	630	47pF	±5%	5.5	4.0	6.0	5.0	3.15	16.0	2M1	2000
	RCE5C2J560J1M1H03A	C0G	630	56pF	±5%	4.0	3.5	5.0	5.0	3.15	16.0	1M1	2000
	RCE5C2J560J2M1H03A	C0G	630	56pF	±5%	5.5	4.0	6.0	5.0	3.15	16.0	2M1	2000
	RCE5C2J680J1M1H03A	C0G	630	68pF	±5%	4.0	3.5	5.0	5.0	3.15	16.0	1M1	2000
	RCE5C2J680J2M1H03A	C0G	630	68pF	±5%	5.5	4.0	6.0	5.0	3.15	16.0	2M1	2000
	RCE5C2J820J1M1H03A	C0G	630	82pF	±5%	4.0	3.5	5.0	5.0	3.15	16.0	1M1	2000
	RCE5C2J820J2M1H03A	C0G	630	82pF	±5%	5.5	4.0	6.0	5.0	3.15	16.0	2M1	2000
	RCE5C2J101J1M1H03A	C0G	630	100pF	±5%	4.0	3.5	5.0	5.0	3.15	16.0	1M1	2000
	RCE5C2J101J2M1H03A	C0G	630	100pF	±5%	5.5	4.0	6.0	5.0	3.15	16.0	2M1	2000
	RCE5C2J121J1M1H03A	C0G	630	120pF	±5%	4.0	3.5	5.0	5.0	3.15	16.0	1M1	2000
	RCE5C2J121J2M1H03A	C0G	630	120pF	±5%	5.5	4.0	6.0	5.0	3.15	16.0	2M1	2000
	RCE5C2J151J1M1H03A	C0G	630	150pF	±5%	4.0	3.5	5.0	5.0	3.15	16.0	1M1	2000
	RCE5C2J151J2M1H03A	C0G	630	150pF	±5%	5.5	4.0	6.0	5.0	3.15	16.0	2M1	2000
	RCE5C2J181J1M1H03A	C0G	630	180pF	±5%	4.0	3.5	5.0	5.0	3.15	16.0	1M1	2000
	RCE5C2J181J2M1H03A	C0G	630	180pF	±5%	5.5	4.0	6.0	5.0	3.15	16.0	2M1	2000
	RCE5C2J221J1M1H03A	C0G	630	220pF	±5%	4.0	3.5	5.0	5.0	3.15	16.0	1M1	2000
	RCE5C2J221J2M1H03A	C0G	630	220pF	±5%	5.5	4.0	6.0	5.0	3.15	16.0	2M1	2000
	RCE5C2J271J1M1H03A	C0G	630	270pF	±5%	4.0	3.5	5.0	5.0	3.15	16.0	1M1	2000
	RCE5C2J271J2M1H03A	C0G	630	270pF	±5%	5.5	4.0	6.0	5.0	3.15	16.0	2M1	2000
	RCE5C2J331J1M1H03A	C0G	630	330pF	±5%	4.0	3.5	5.0	5.0	3.15	16.0	1M1	2000
	RCE5C2J331J2M1H03A	C0G	630	330pF	±5%	5.5	4.0	6.0	5.0	3.15	16.0	2M1	2000
	RCE5C2J391J1M1H03A	C0G	630	390pF	±5%	4.0	3.5	5.0	5.0	3.15	16.0	1M1	2000
	RCE5C2J391J2M1H03A	C0G	630	390pF	±5%	5.5	4.0	6.0	5.0	3.15	16.0	2M1	2000
	RCE5C2J471J1M1H03A	C0G	630	470pF	±5%	4.0	3.5	5.0	5.0	3.15	16.0	1M1	2000
	RCE5C2J471J2M1H03A	C0G	630	470pF	±5%	5.5	4.0	6.0	5.0	3.15	16.0	2M1	2000

• Inside Crimp Taping
(Lead Style: M*)

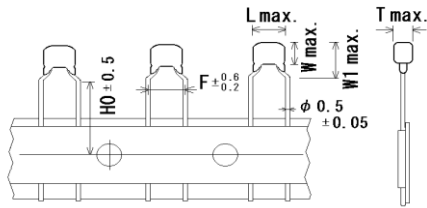

Unit : mm

Customer Part Number	Murata Part Number	T.C.	DC Rated Volt. (V)	Cap.	Cap. Tol.	Dimension (mm)						Dimension (LxW) Lead Style	Pack qty. (pcs)
						L	W	W1	F	T	H/HO		
	RCE5C2J561J1M1H03A	C0G	630	560pF	±5%	4.0	3.5	5.0	5.0	3.15	16.0	1M1	2000
	RCE5C2J561J2M1H03A	C0G	630	560pF	±5%	5.5	4.0	6.0	5.0	3.15	16.0	2M1	2000
	RCE5C2J681J1M1H03A	C0G	630	680pF	±5%	4.0	3.5	5.0	5.0	3.15	16.0	1M1	2000
	RCE5C2J681J2M1H03A	C0G	630	680pF	±5%	5.5	4.0	6.0	5.0	3.15	16.0	2M1	2000
	RCE5C2J821J1M1H03A	C0G	630	820pF	±5%	4.0	3.5	5.0	5.0	3.15	16.0	1M1	2000
	RCE5C2J821J2M1H03A	C0G	630	820pF	±5%	5.5	4.0	6.0	5.0	3.15	16.0	2M1	2000
	RCE5C2J102J1M1H03A	C0G	630	1000pF	±5%	4.0	3.5	5.0	5.0	3.15	16.0	1M1	2000
	RCE5C2J102J2M1H03A	C0G	630	1000pF	±5%	5.5	4.0	6.0	5.0	3.15	16.0	2M1	2000
	RCE5C2J122J1M1H03A	C0G	630	1200pF	±5%	4.0	3.5	5.0	5.0	3.15	16.0	1M1	2000
	RCE5C2J122J2M1H03A	C0G	630	1200pF	±5%	5.5	4.0	6.0	5.0	3.15	16.0	2M1	2000
	RCE5C2J152J1M1H03A	C0G	630	1500pF	±5%	4.0	3.5	5.0	5.0	3.15	16.0	1M1	2000
	RCE5C2J152J2M1H03A	C0G	630	1500pF	±5%	5.5	4.0	6.0	5.0	3.15	16.0	2M1	2000
	RCE5C2J182J1M1H03A	C0G	630	1800pF	±5%	4.0	3.5	5.0	5.0	3.15	16.0	1M1	2000
	RCE5C2J182J2M1H03A	C0G	630	1800pF	±5%	5.5	4.0	6.0	5.0	3.15	16.0	2M1	2000
	RCE5C2J222J1M1H03A	C0G	630	2200pF	±5%	4.0	3.5	5.0	5.0	3.15	16.0	1M1	2000
	RCE5C2J222J2M1H03A	C0G	630	2200pF	±5%	5.5	4.0	6.0	5.0	3.15	16.0	2M1	2000
	RCE5C2J272J2M1H03A	C0G	630	2700pF	±5%	5.5	4.0	6.0	5.0	3.15	16.0	2M1	2000
	RCE5C2J332J2M1H03A	C0G	630	3300pF	±5%	5.5	4.0	6.0	5.0	3.15	16.0	2M1	2000
	RCE5C2J392J2M1H03A	C0G	630	3900pF	±5%	5.5	4.0	6.0	5.0	3.15	16.0	2M1	2000
	RCE5C2J472J2M1H03A	C0G	630	4700pF	±5%	5.5	4.0	6.0	5.0	3.15	16.0	2M1	2000
	RCE5C3A100J2M1H03A	C0G	1000	10pF	±5%	5.5	4.0	6.0	5.0	3.15	16.0	2M1	2000
	RCE5C3A120J2M1H03A	C0G	1000	12pF	±5%	5.5	4.0	6.0	5.0	3.15	16.0	2M1	2000
	RCE5C3A150J2M1H03A	C0G	1000	15pF	±5%	5.5	4.0	6.0	5.0	3.15	16.0	2M1	2000
	RCE5C3A180J2M1H03A	C0G	1000	18pF	±5%	5.5	4.0	6.0	5.0	3.15	16.0	2M1	2000
	RCE5C3A220J2M1H03A	C0G	1000	22pF	±5%	5.5	4.0	6.0	5.0	3.15	16.0	2M1	2000
	RCE5C3A270J2M1H03A	C0G	1000	27pF	±5%	5.5	4.0	6.0	5.0	3.15	16.0	2M1	2000
	RCE5C3A330J2M1H03A	C0G	1000	33pF	±5%	5.5	4.0	6.0	5.0	3.15	16.0	2M1	2000
	RCE5C3A390J2M1H03A	C0G	1000	39pF	±5%	5.5	4.0	6.0	5.0	3.15	16.0	2M1	2000
	RCE5C3A470J2M1H03A	C0G	1000	47pF	±5%	5.5	4.0	6.0	5.0	3.15	16.0	2M1	2000
	RCE5C3A560J2M1H03A	C0G	1000	56pF	±5%	5.5	4.0	6.0	5.0	3.15	16.0	2M1	2000
	RCE5C3A680J2M1H03A	C0G	1000	68pF	±5%	5.5	4.0	6.0	5.0	3.15	16.0	2M1	2000
	RCE5C3A820J2M1H03A	C0G	1000	82pF	±5%	5.5	4.0	6.0	5.0	3.15	16.0	2M1	2000
	RCE5C3A101J2M1H03A	C0G	1000	100pF	±5%	5.5	4.0	6.0	5.0	3.15	16.0	2M1	2000
	RCE5C3A121J2M1H03A	C0G	1000	120pF	±5%	5.5	4.0	6.0	5.0	3.15	16.0	2M1	2000
	RCE5C3A151J2M1H03A	C0G	1000	150pF	±5%	5.5	4.0	6.0	5.0	3.15	16.0	2M1	2000
	RCE5C3A181J2M1H03A	C0G	1000	180pF	±5%	5.5	4.0	6.0	5.0	3.15	16.0	2M1	2000
	RCE5C3A221J2M1H03A	C0G	1000	220pF	±5%	5.5	4.0	6.0	5.0	3.15	16.0	2M1	2000
	RCE5C3A271J2M1H03A	C0G	1000	270pF	±5%	5.5	4.0	6.0	5.0	3.15	16.0	2M1	2000
	RCE5C3A331J2M1H03A	C0G	1000	330pF	±5%	5.5	4.0	6.0	5.0	3.15	16.0	2M1	2000
	RCE5C3A391J2M1H03A	C0G	1000	390pF	±5%	5.5	4.0	6.0	5.0	3.15	16.0	2M1	2000

• Inside Crimp Taping
(Lead Style: M*)

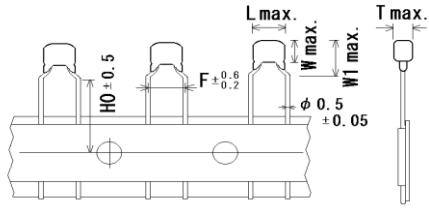

Unit : mm

Customer Part Number	Murata Part Number	T.C.	DC Rated Volt. (V)	Cap.	Cap. Tol.	Dimension (mm)						Dimension (LxW) Lead Style	Pack qty. (pcs)
						L	W	W1	F	T	H/H0		
	RCE5C3A471J2M1H03A	C0G	1000	470pF	±5%	5.5	4.0	6.0	5.0	3.15	16.0	2M1	2000
	RCE5C3A561J2M1H03A	C0G	1000	560pF	±5%	5.5	4.0	6.0	5.0	3.15	16.0	2M1	2000
	RCE5C3A681J2M1H03A	C0G	1000	680pF	±5%	5.5	4.0	6.0	5.0	3.15	16.0	2M1	2000
	RCE5C3A821J2M1H03A	C0G	1000	820pF	±5%	5.5	4.0	6.0	5.0	3.15	16.0	2M1	2000
	RCE5C3A102J2M1H03A	C0G	1000	1000pF	±5%	5.5	4.0	6.0	5.0	3.15	16.0	2M1	2000

Reference only

5. AEC-Q200 Murata Standard Specifications and Test Methods																			
No.	AEC-Q200 Test Item	Specification	AEC-Q200 Test Method																
1	Pre-and Post-Stress Electrical Test		-																
2	High Temperature Exposure (Storage)	Appearance	No defects or abnormalities.	Sit the capacitor for 1000±12h at 150±3°C. Let sit for 24±2h at *room condition, then measure.															
		Capacitance Change	Within ±3% or ±0.3pF (Whichever is larger)																
		Q	$30\text{pF} \leq C : Q \geq 350$ $10\text{pF} \leq C < 30\text{pF} : Q \geq 275+5C/2$ $10\text{pF} > C : Q \geq 200+10C$ C : Nominal Capacitance (pF)																
		I.R.	More than 1,000MΩ or 50 MΩ·μF (Whichever is smaller)																
3	Temperature Cycling	Appearance	No defects or abnormalities.	Perform the 1000 cycles according to the four heat treatments listed in the following table. Let sit for 24±2 h at *room condition, then measure.															
		Capacitance Change	Within ±5% or ±0.5pF (Whichever is larger)																
		Q	$30\text{pF} \leq C : Q \geq 350$ $10\text{pF} \leq C < 30\text{pF} : Q \geq 275+5C/2$ $10\text{pF} > C : Q \geq 200+10C$ C : Nominal Capacitance (pF)																
		I.R.	1,000MΩ or 50MΩ · μF min. (Whichever is smaller)																
		<table border="1" style="margin-left: auto; margin-right: auto;"> <thead> <tr> <th>Step</th> <th>1</th> <th>2</th> <th>3</th> <th>4</th> </tr> </thead> <tbody> <tr> <td>Temp. (°C)</td> <td>-55+0/-3</td> <td>Room Temp.</td> <td>125+3/-0</td> <td>Room Temp.</td> </tr> <tr> <td>Time (min.)</td> <td>15±3</td> <td>1</td> <td>15±3</td> <td>1</td> </tr> </tbody> </table>			Step	1	2	3	4	Temp. (°C)	-55+0/-3	Room Temp.	125+3/-0	Room Temp.	Time (min.)	15±3	1	15±3	1
Step	1	2	3	4															
Temp. (°C)	-55+0/-3	Room Temp.	125+3/-0	Room Temp.															
Time (min.)	15±3	1	15±3	1															
4	Moisture Resistance	Appearance	No defects or abnormalities.	Apply the 24h heat (25 to 65°C) and humidity (80 to 98%) treatment shown below, 10 consecutive times. Let sit for 24±2 h at *room condition, then measure.															
		Capacitance Change	Within ±5% or ± 0.5pF (Whichever is larger)																
		Q	$30\text{pF} \leq C : Q \geq 200$ $30\text{pF} > C : Q \geq 100+10C/3$ C : Nominal Capacitance (pF)																
		I.R.	500MΩ or 25MΩ·μF min. (Whichever is smaller)																
5	Biased Humidity	Appearance	No defects or abnormalities.	Apply the rated voltage and DC1.3+0.2/-0V (add 100kΩ resistor) at 85±3°C and 80 to 85% humidity for 1000±12h. Remove and let sit for 24±2 h at *room condition, then measure. The charge/discharge current is less than 50mA.															
		Capacitance Change	Within ±5% or ± 0.5pF (Whichever is larger)																
		Q	$30\text{pF} \leq C : Q \geq 200$ $30\text{pF} > C : Q \geq 100+10C/3$ C : Nominal Capacitance (pF)																
		I.R.	500MΩ or 25MΩ·μF min. (Whichever is smaller)																

* "room condition" Temperature : 15 to 35°C, Relative humidity : 45 to 75%, Atmosphere pressure : 86 to 106kPa

Reference only

No.	AEC-Q200 Test Item		Specification	AEC-Q200 Test Method						
6	Operational Life	Appearance	No defects or abnormalities.	Apply voltage in Table for 1000±12h at 125±3°C. Let sit for 24±2 h at *room condition, then measure. The charge/discharge current is less than 50mA. <table border="1" data-bbox="906 338 1331 427"> <thead> <tr> <th>Rated Voltage</th> <th>Test Voltage</th> </tr> </thead> <tbody> <tr> <td>DC250V</td> <td>150% of the rated voltage</td> </tr> <tr> <td>DC630V, DC1kV</td> <td>120% of the rated voltage</td> </tr> </tbody> </table>	Rated Voltage	Test Voltage	DC250V	150% of the rated voltage	DC630V, DC1kV	120% of the rated voltage
		Rated Voltage	Test Voltage							
		DC250V	150% of the rated voltage							
		DC630V, DC1kV	120% of the rated voltage							
Capacitance	Within ±3% or ±0.3pF									
Change	(Whichever is larger)									
Q	30pF ≤ C : Q ≥ 350 10pF ≤ C < 30pF : Q ≥ 275+5C/2 10pF > C : Q ≥ 200+10C C : Nominal Capacitance (pF)									
I.R.	1,000MΩ or 50MΩ·μF min. (Whichever is smaller)									
7	External Visual		No defects or abnormalities.	Visual inspection.						
8	Physical Dimension		Within the specified dimensions.	Using calipers and micrometers.						
9	Marking		To be easily legible.	Visual inspection.						
10	Resistance to Solvents	Appearance	No defects or abnormalities.	Per MIL-STD-202 Method 215 Solvent 1 : 1 part (by volume) of isopropyl alcohol 3 parts (by volume) of mineral spirits Solvent 2 : Terpene defluxer Solvent 3 : 42 parts (by volume) of water 1part (by volume) of propylene glycol monomethyl ether 1 part (by volume) of monoethanolamine						
		Capacitance	Within the specified tolerance.							
		Q	30pF ≤ C : Q ≥ 1,000 30pF > C : Q ≥ 400+20C C : Nominal Capacitance (pF)							
		I.R.	More than 10,000MΩ or 500 MΩ·μF (Whichever is smaller)							
11	Mechanical Shock	Appearance	No defects or abnormalities.	Three shocks in each direction should be applied along 3 mutually perpendicular axes of the test specimen (18 shocks). The specified test pulse should be Half-sine and should have a duration : 0.5ms, peak value : 1500G and velocity change : 4.7m/s.						
		Capacitance	Within the specified tolerance.							
		Q	30pF ≤ C : Q ≥ 1,000 30pF > C : Q ≥ 400+20C C : Nominal Capacitance (pF)							
		I.R.	More than 10,000MΩ or 500 MΩ·μF (Whichever is smaller)							
12	Vibration	Appearance	No defects or abnormalities.	The capacitor should be subjected to a simple harmonic motion having a total amplitude of 1.5mm, the frequency being varied uniformly between the approximate limits of 10 and 2000Hz. The frequency range, from 10 to 2,000Hz and return to 10Hz, should be traversed in approximately 20 min. This motion should be applied for 12 items in each 3 mutually perpendicular directions (total of 36 times).						
		Capacitance	Within the specified tolerance.							
		Q	30pF ≤ C : Q ≥ 1,000 30pF > C : Q ≥ 400+20C C : Nominal Capacitance (pF)							
		I.R.	More than 10,000MΩ or 500 MΩ·μF (Whichever is smaller)							
13-1	Resistance to Soldering Heat (Non-Preheat)	Appearance	No defects or abnormalities.	The lead wires should be immersed in the melted solder 1.5 to 2.0mm from the root of terminal at 260±5°C for 10±1 seconds. • Post-treatment Capacitor should be stored for 24±2 hours at *room condition.						
		Capacitance	Within ±2.5% or ±0.25pF							
		Change	(Whichever is larger)							
		Dielectric Strength (Between terminals)	No defects							
13-2	Resistance to Soldering Heat (On-Preheat)	Appearance	No defects or abnormalities.	First the capacitor should be stored at 120+0/-5°C for 60+0/-5 seconds. Then, the lead wires should be immersed in the melted solder 1.5 to 2.0mm from the root of terminal at 260±5°C for 7.5+0/-1 seconds. • Post-treatment Capacitor should be stored for 24±2 hours at *room condition.						
		Capacitance	Within ±2.5% or ±0.25pF							
		Change	(Whichever is larger)							
		Dielectric Strength (Between terminals)	No defects							
13-3	Resistance to Soldering Heat (soldering iron method)	Appearance	No defects or abnormalities.	Test condition Temperature of iron-tip : 350±10°C Soldering time : 3.5±0.5 seconds Soldering position Straight Lead : 1.5 to 2.0mm from the root of terminal. Crimp Lead : 1.5 to 2.0mm from the end of bend. • Post-treatment Capacitor should be stored for 24±2 hours at *room condition.						
		Capacitance	Within ±2.5% or ±0.25pF							
		Change	(Whichever is larger)							
		Dielectric Strength (Between terminals)	No defects							

* "room condition" Temperature : 15 to 35°C, Relative humidity : 45 to 75%, Atmosphere pressure : 86 to 106kPa

Reference only

No.	AEC-Q200 Test Item		Specifications	AEC-Q200 Test Method									
14	Thermal Shock	Appearance	No defects or abnormalities.	Perform the 300 cycles according to the two heat treatments listed in the following table(Maximum transfer time is 20s.). Let sit for 24±2 h at *room condition, then measure. <table border="1"> <thead> <tr> <th>Step</th> <th>1</th> <th>2</th> </tr> </thead> <tbody> <tr> <td>Temp. (°C)</td> <td>-55+0/-3</td> <td>125+3/-0</td> </tr> <tr> <td>Time (min.)</td> <td>15±3</td> <td>15±3</td> </tr> </tbody> </table>	Step	1	2	Temp. (°C)	-55+0/-3	125+3/-0	Time (min.)	15±3	15±3
		Step	1		2								
		Temp. (°C)	-55+0/-3		125+3/-0								
		Time (min.)	15±3		15±3								
Capacitance Change	Within ±5% or ±0.5pF (Whichever is larger)												
Q	30pF ≤ C : Q ≥ 350 10pF ≤ C < 30pF : Q ≥ 275+5C/2 10pF > C : Q ≥ 200+10C C : Nominal Capacitance (pF)												
I.R.	1,000MΩ or 50MΩ·μF min. (Whichever is smaller)												
15	ESD	Appearance	No defects or abnormalities.	Per AEC-Q200-002									
		Capacitance	Within the specified tolerance.										
		Q	30pF ≤ C : Q ≥ 1,000 30pF > C : Q ≥ 400+20C C : Nominal Capacitance (pF)										
		I.R.	More than 10,000MΩ or 500 MΩ·μF (Whichever is smaller)										
16	Solderability	Lead wire should be soldered with uniform coating on the axial direction over 95% of the circumferential direction.	Should be placed into steam aging for 8h±15 min. The terminal of capacitor is dipped into a solution of ethanol (JIS K 8101) and rosin (JIS K 5902) (25% rosin in weight propotion). Immerse in solder solution for 2±0.5 seconds. In both cases the depth of dipping is up to about 1.5 to 2mm from the terminal body. Temp. of solder : 245±5°C Lead Free Solder (Sn-3.0Ag-0.5Cu) 235±5°C H60A or H63A Eutectic Solder										
17	Electrical Characterization	Appearance	No defects or abnormalities.	Visual inspection.									
		Capacitance	Within the specified tolerance.	The capacitance, Q should be measured at 25°C at the frequency and voltage shown in the table. <table border="1"> <thead> <tr> <th>Nominal Cap.</th> <th>Frequency</th> <th>Voltage</th> </tr> </thead> <tbody> <tr> <td>C ≤ 1000pF</td> <td>1±0.1MHz</td> <td>AC0.5 to 5V(r.m.s.)</td> </tr> <tr> <td>C > 1000pF</td> <td>1±0.1kHz</td> <td>AC1±0.2V(r.m.s.)</td> </tr> </tbody> </table>	Nominal Cap.	Frequency	Voltage	C ≤ 1000pF	1±0.1MHz	AC0.5 to 5V(r.m.s.)	C > 1000pF	1±0.1kHz	AC1±0.2V(r.m.s.)
		Nominal Cap.	Frequency		Voltage								
		C ≤ 1000pF	1±0.1MHz	AC0.5 to 5V(r.m.s.)									
		C > 1000pF	1±0.1kHz	AC1±0.2V(r.m.s.)									
Q	30pF ≤ C : Q ≥ 1,000 30pF > C : Q ≥ 400+20C C : Nominal Capacitance (pF)												
I.R.	Between Terminals 10,000MΩ or 50MΩ·μF min. (Whichever is smaller)	The insulation resistance should be measured with DC500±50V (DC250V±25V in case of rated voltage : DC250V) at 25 °C within 2 min. of charging.											
Dielectric Strength	Between Terminals No defects or abnormalities.	The capacitor should not be damaged when voltage in Table is applied between the terminations for 1 to 5 seconds. (Charge/Discharge current ≤ 50mA.) <table border="1"> <thead> <tr> <th>Rated Voltage</th> <th>Test Voltage</th> </tr> </thead> <tbody> <tr> <td>DC250V</td> <td>200% of the rated voltage</td> </tr> <tr> <td>DC630V</td> <td>150% of the rated voltage</td> </tr> <tr> <td>DC1kV</td> <td>130% of the rated voltage</td> </tr> </tbody> </table>	Rated Voltage	Test Voltage	DC250V	200% of the rated voltage	DC630V	150% of the rated voltage	DC1kV	130% of the rated voltage			
Rated Voltage	Test Voltage												
DC250V	200% of the rated voltage												
DC630V	150% of the rated voltage												
DC1kV	130% of the rated voltage												
Body Insulation	Body Insulation No defects or abnormalities.	The capacitor is placed in a container with metal balls of 1mm diameter so that each terminal, short-circuit is kept approximately 2mm from the balls, and voltage in table is impressed for 1 to 5 seconds between capacitor terminals and metal balls. (Charge/Discharge current ≤ 50mA.) <table border="1"> <thead> <tr> <th>Rated Voltage</th> <th>Test Voltage</th> </tr> </thead> <tbody> <tr> <td>DC250V</td> <td>DC500V</td> </tr> <tr> <td>DC630V,DC1kV</td> <td>DC1.3kV</td> </tr> </tbody> </table>	Rated Voltage	Test Voltage	DC250V	DC500V	DC630V,DC1kV	DC1.3kV					
Rated Voltage	Test Voltage												
DC250V	DC500V												
DC630V,DC1kV	DC1.3kV												
* "room condition" Temperature : 15 to 35°C, Relative humidity : 45 to 75%, Atmosphere pressure : 86 to 106kPa													

Reference only

No.	AEC-Q200 Test Item		Specifications	AEC-Q200 Test Method												
18	Terminal Strength	Tensile Strength	Termination not to be broken or loosened.	As in the figure, fix the capacitor body, apply the force gradually to each lead in the radial direction of the capacitor until reaching 10N and then keep the force applied for 10±1 seconds. 												
		Bending Strength	Termination not to be broken or loosened.	Each lead wire should be subjected to a force of 2.5N and then be bent 90° at the point of egress in one direction. Each wire is then returned to the original position and bent 90° in the opposite direction at the rate of one bend per 2 to 3 seconds.												
19	Capacitance Temperature Characteristics		Within the specified Tolerance. 25°C to 125°C : 0±30ppm/°C -55°C to 25°C : 0+30/-72ppm/°C	The capacitance change should be measured after 5min. at each specified temperature step. <table border="1" data-bbox="1007 618 1225 792" style="margin-left: auto; margin-right: auto;"> <thead> <tr> <th>Step</th> <th>Temperature(°C)</th> </tr> </thead> <tbody> <tr> <td>1</td> <td>25±2</td> </tr> <tr> <td>2</td> <td>-55±3</td> </tr> <tr> <td>3</td> <td>25±2</td> </tr> <tr> <td>4</td> <td>125±3</td> </tr> <tr> <td>5</td> <td>25±2</td> </tr> </tbody> </table> <p>The temperature coefficient is determined using the capacitance measured in step 3 as a reference. When cycling the temperature sequentially from step 1 through 5 (-55°C to 125°C) the capacitance should be within the specified tolerance for the temperature coefficient and capacitance change as Table A. The capacitance drift is calculated by dividing the differences between the maximum and minimum measured values in the step 1, 3 and 5 by the capacitance value in step 3.</p>	Step	Temperature(°C)	1	25±2	2	-55±3	3	25±2	4	125±3	5	25±2
Step	Temperature(°C)															
1	25±2															
2	-55±3															
3	25±2															
4	125±3															
5	25±2															

6. Packing specification

•Bulk type (Packing style code : B)

The size of packing case and packing way

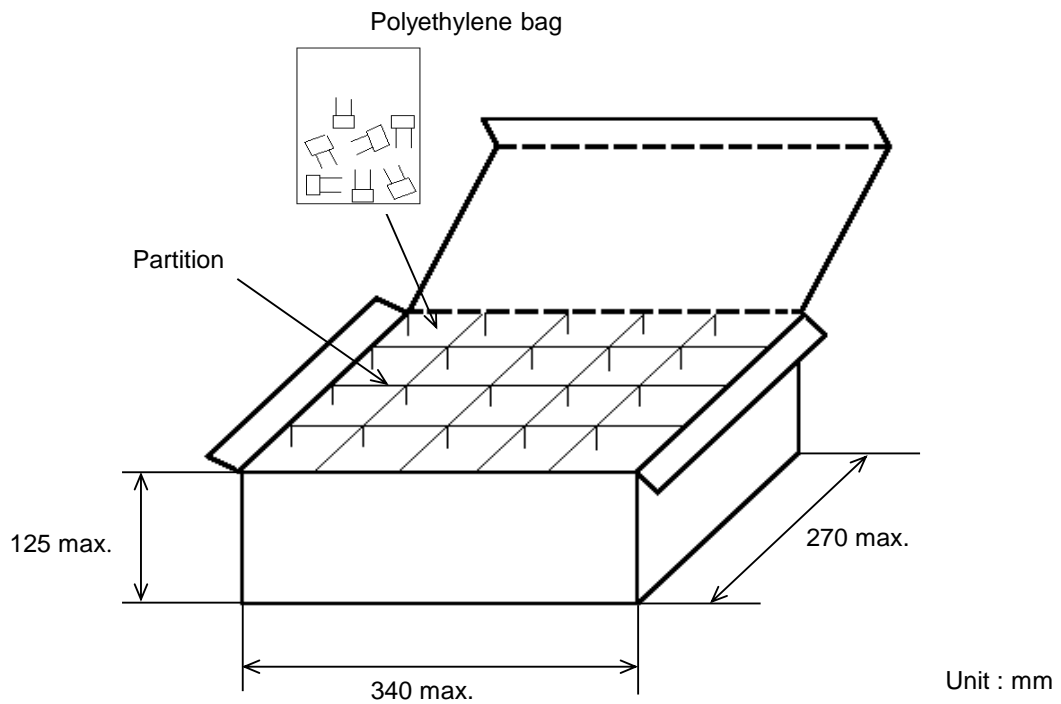

The number of packing = ^{*1} Packing quantity × ^{*2} n

*1 : Please refer to [Part number list].

*2 : Standard n = 20 (bag)

Note)

The outer package and the number of outer packing be changed by the order getting amount.

• Ammo pack taping type (Packing style code : A)

A crease is made every 25 pitches, and the tape with capacitors is packed zigzag into a case. When body of the capacitor is piled on other body under it.

The size of packing case and packing way

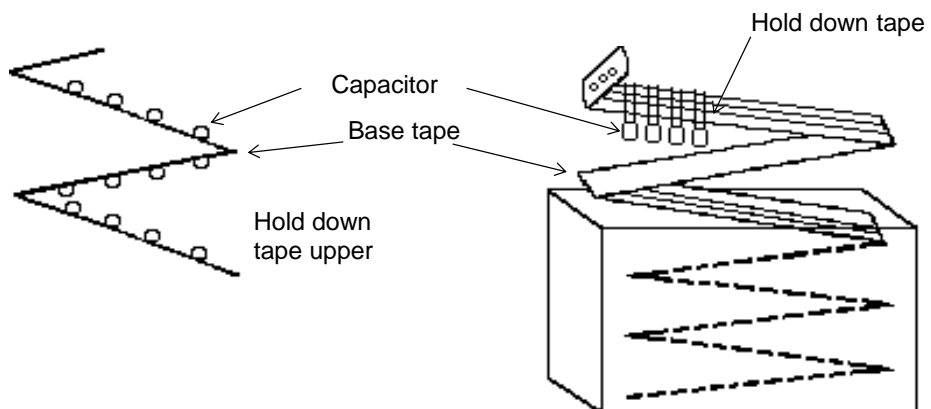
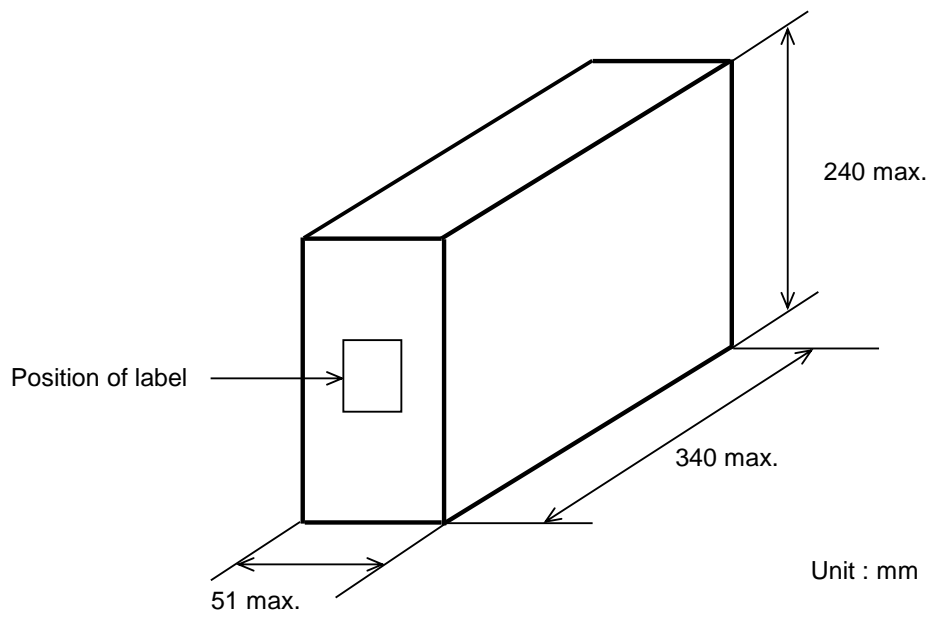

7. Taping specification

7-1. Dimension of capacitors on tape

Inside crimp taping type < Lead Style : M1 >

Pitch of component 12.7mm / Lead spacing 5.0mm

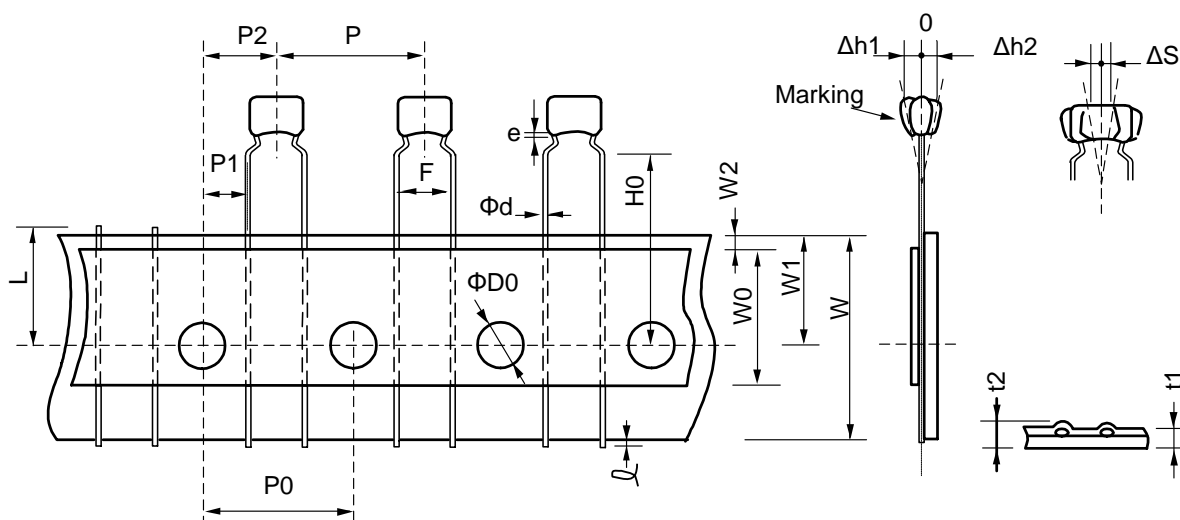

Unit : mm

Item	Code	Dimensions	Remarks
Pitch of component	P	12.7+/-1.0	
Pitch of sprocket hole	P0	12.7+/-0.2	
Lead spacing	F	5.0+0.6/-0.2	
Length from hole center to component center	P2	6.35+/-1.3	Deviation of progress direction
Length from hole center to lead	P1	3.85+/-0.7	
Deviation along tape, left or right defect	ΔS	0+/-2.0	They include deviation by lead bend
Carrier tape width	W	18.0+/-0.5	
Position of sprocket hole	W1	9.0+0/-0.5	Deviation of tape width direction
Lead distance between reference and bottom plane	H0	16.0+/-0.5	
Protrusion length	ℓ	0.5 max.	
Diameter of sprocket hole	ΦD0	4.0+/-0.1	
Lead diameter	Φd	0.5+/-0.05	
Total tape thickness	t1	0.6+/-0.3	They include hold down tape thickness
Total thickness of tape and lead wire	t2	1.5 max.	
Deviation across tape	Δh1	2.0 max. (Dimension code : W)	
	Δh2	1.0 max. (except as above)	
Portion to cut in case of defect	L	11.0+0/-1.0	
Hold down tape width	W0	9.5 min.	
Hold down tape position	W2	1.5+/-1.5	
Coating extension on lead	e	Up to the end of crimp	

7-2. Splicing way of tape

1) Adhesive force of tape is over 3N at test condition as below.

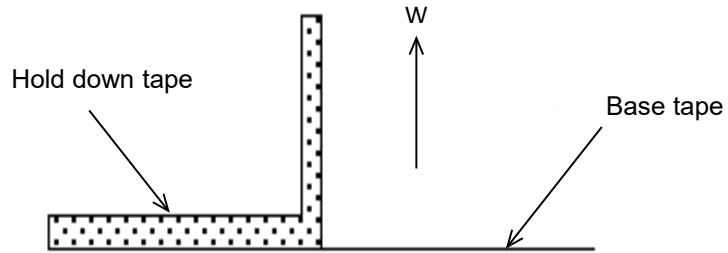

2) Splicing of tape

a) When base tape is spliced

- Base tape shall be spliced by cellophane tape.
(Total tape thickness shall be less than 1.05mm.)

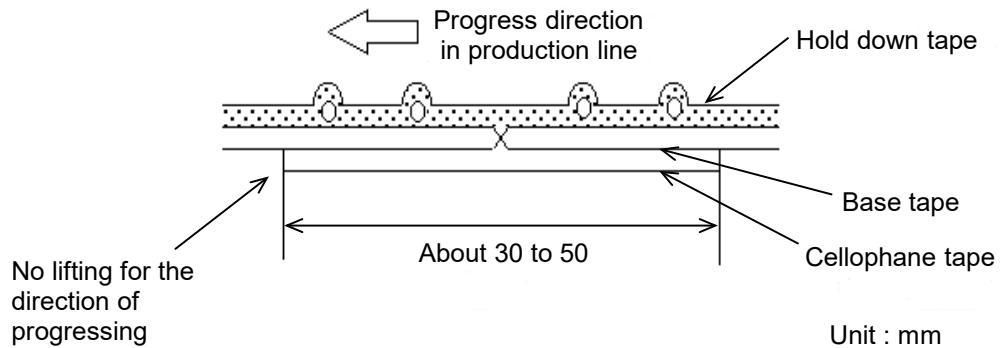

b) When hold down tape is spliced

- Hold down tape shall be spliced with overlapping.
(Total tape thickness shall be less than 1.05mm.)

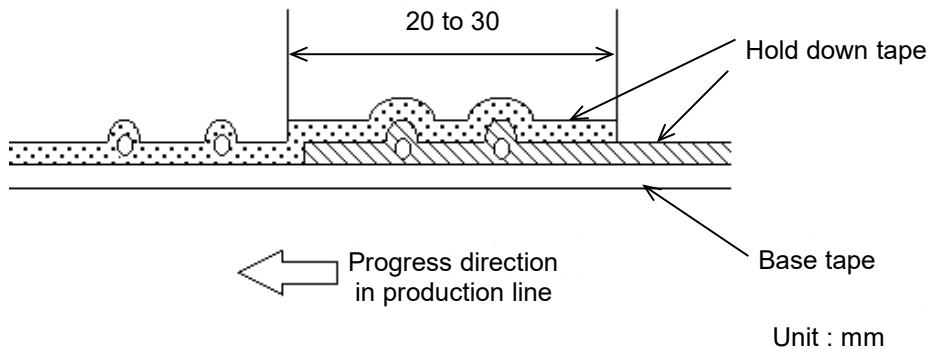

c) When both tape are spliced

- Base tape and hold down tape shall be spliced with splicing tape.

Mouser Electronics

Authorized Distributor

Click to View Pricing, Inventory, Delivery & Lifecycle Information:

Murata:

[RCE5C2J101J2M1H03A](#) [RCE5C2E182J2M1H03A](#) [RCE5C2E392J2K1H03B](#) [RCE5C2E271J2M1H03A](#)
[RCE5C2E682J2K1H03B](#) [RCE5C2E121J2K1H03B](#) [RCE5C2E182J2K1H03B](#) [RCE5C2J471J2M1H03A](#)
[RCE5C2E822J2K1H03B](#) [RCE5C2E180J2M1H03A](#) [RCE5C2E682J2M1H03A](#) [RCE5C2J681J2M1H03A](#)
[RCE5C2E120J2K1H03B](#) [RCE5C2J221J2M1H03A](#) [RCE5C2E680J2K1H03B](#) [RCE5C3A101J2K1H03B](#)
[RCE5C2J121J2M1H03A](#) [RCE5C3A121J2K1H03B](#) [RCE5C3A271J2M1H03A](#) [RCE5C2J271J2M1H03A](#)
[RCE5C2E470J2K1H03B](#) [RCE5C2E180J2K1H03B](#) [RCE5C2E100J2M1H03A](#) [RCE5C3A681J2K1H03B](#)
[RCE5C2J121J2K1H03B](#) [RCE5C2E470J2M1H03A](#) [RCE5C2J150J2K1H03B](#) [RCE5C2J151J2M1H03A](#)
[RCE5C2J182J2K1H03B](#) [RCE5C2J821J2M1H03A](#) [RCE5C2J272J2M1H03A](#) [RCE5C2E151J2K1H03B](#)
[RCE5C2E332J2M1H03A](#) [RCE5C2J390J2K1H03B](#) [RCE5C2J330J2M1H03A](#) [RCE5C2E332J2K1H03B](#)
[RCE5C3A102J2K1H03B](#) [RCE5C2E272J2K1H03B](#) [RCE5C3A681J2M1H03A](#) [RCE5C2J222J2M1H03A](#)
[RCE5C2J331J2K1H03B](#) [RCE5C2J100J2M1H03A](#) [RCE5C2J180J2M1H03A](#) [RCE5C2E472J2M1H03A](#)
[RCE5C3A271J2K1H03B](#) [RCE5C2J102J2M1H03A](#) [RCE5C2J182J2M1H03A](#) [RCE5C2E331J2M1H03A](#)
[RCE5C2J180J2K1H03B](#) [RCE5C2E561J2K1H03B](#) [RCE5C2E122J2M1H03A](#) [RCE5C3A121J2M1H03A](#)
[RCE5C2E150J2M1H03A](#) [RCE5C2E181J2K1H03B](#) [RCE5C3A181J2M1H03A](#) [RCE5C2E330J2M1H03A](#)
[RCE5C2J270J2M1H03A](#) [RCE5C2J150J2M1H03A](#) [RCE5C2E222J2K1H03B](#) [RCE5C3A101J2M1H03A](#)
[RCE5C2E270J2M1H03A](#) [RCE5C3A821J2M1H03A](#) [RCE5C2J680J2M1H03A](#) [RCE5C3A391J2M1H03A](#)
[RCE5C2E123J2K1H03B](#) [RCE5C2E222J2M1H03A](#) [RCE5C2J470J2M1H03A](#) [RCE5C3A102J2M1H03A](#)
[RCE5C2J561J2K1H03B](#) [RCE5C2E391J2M1H03A](#) [RCE5C2J120J2K1H03B](#) [RCE5C3A151J2M1H03A](#)
[RCE5C2J220J2K1H03B](#) [RCE5C2J151J2K1H03B](#) [RCE5C2J332J2K1H03B](#) [RCE5C2E271J2K1H03B](#)
[RCE5C2E121J2M1H03A](#) [RCE5C2J560J2K1H03B](#) [RCE5C2E181J2M1H03A](#) [RCE5C2J681J2K1H03B](#)
[RCE5C2E820J2M1H03A](#) [RCE5C2J820J2K1H03B](#) [RCE5C2J102J2K1H03B](#) [RCE5C2E101J2M1H03A](#)
[RCE5C2E471J2M1H03A](#) [RCE5C2J122J2K1H03B](#) [RCE5C2E330J2K1H03B](#) [RCE5C2E680J2M1H03A](#)
[RCE5C2E822J2M1H03A](#) [RCE5C2J120J2M1H03A](#) [RCE5C2E561J2M1H03A](#) [RCE5C2J821J2K1H03B](#)
[RCE5C2J100J2K1H03B](#) [RCE5C2E562J2K1H03B](#) [RCE5C2E152J2M1H03A](#) [RCE5C2E101J2K1H03B](#)
[RCE5C2J391J2M1H03A](#) [RCE5C2J470J2K1H03B](#) [RCE5C2J152J2K1H03B](#) [RCE5C3A471J2K1H03B](#)