

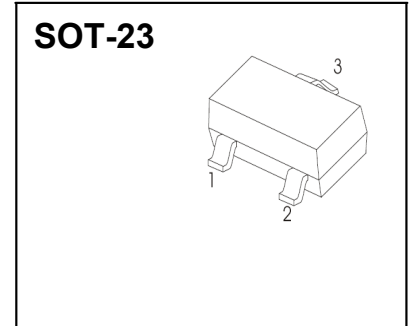

## SOT-23 Plastic-Encapsulate Diodes

### BAW56/BAV70/BAV99 SWITCHING DIODE

#### FEATURES

- Fast Switching Speed
- For General Purpose Switching Applications
- High Conductance

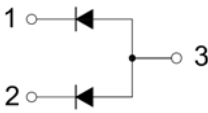
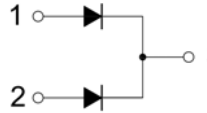
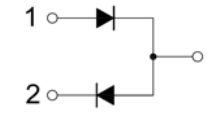
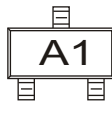

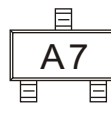
BAW56	BAV70	BAV99
		
MARKING:A1	MARKING:A4	MARKING:A7
		

#### Maximum Ratings @Ta=25°C

Parameter	Symbol	Limit	Unit
Reverse Voltage	$V_R$	70	V
Forward Current	$I_F$	200	mA
Non-Repetitive Peak Forward Surge Current @t=8.3ms	$I_{FSM}$	2.0	A
Power Dissipation	$P_D$	225	mW
Thermal Resistance Junction to Ambient	$R_{\theta JA}$	556	°C/W
Junction Temperature	$T_J$	150	°C
Storage Temperature range	$T_{STG}$	-55~+150	°C

#### Electrical Characteristics @Ta=25°C

Parameter	Symbol	Test Conditions	Min	Typ	Max	Unit
Reverse breakdown voltage	$V_R$	$I_R=100\mu A$	70			V
Forward voltage	$V_{F1}$	$I_F=1mA$			0.715	V
	$V_{F2}$	$I_F=10mA$			0.855	V
	$V_{F3}$	$I_F=50mA$			1	V
	$V_{F4}$	$I_F=150mA$			1.25	V
Reverse current	$I_R$	$V_R=70V$			2.5	$\mu A$
Capacitance between terminals	$C_T$	$V_R=0, f=1MHz$			1.5	pF
Reverse recovery time	$t_{rr}$	$I_F = I_R = 10mA,$ $I_{rr} = 0.1 \times I_R, R_L = 100\Omega$			6	ns



Typical Characteristics

Forward Characteristics

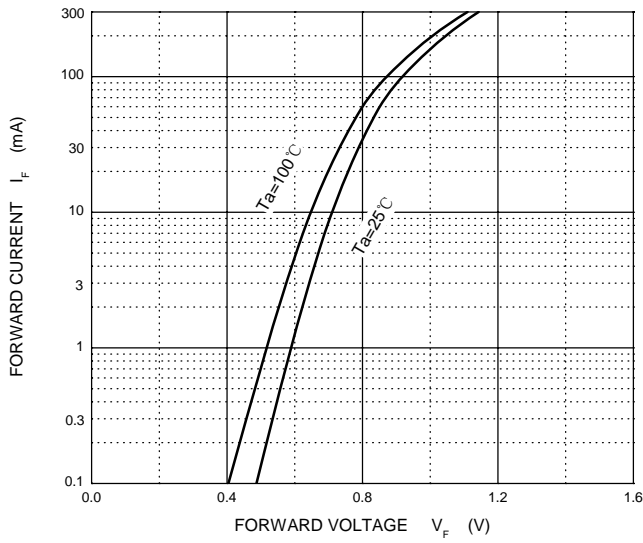

Reverse Characteristics

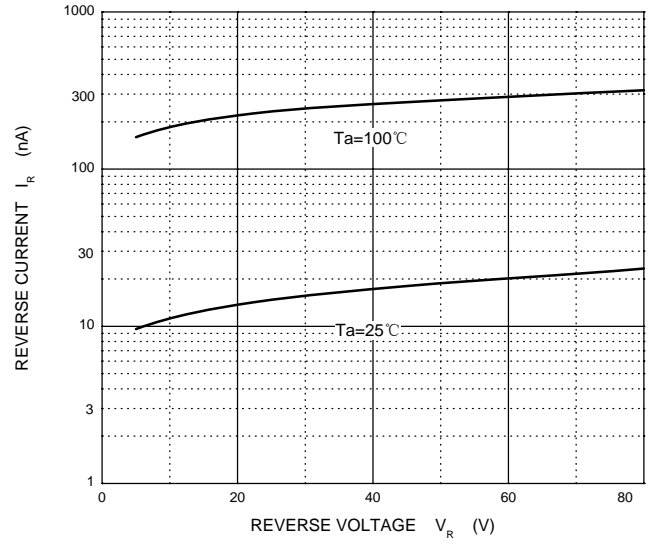

Capacitance Characteristics

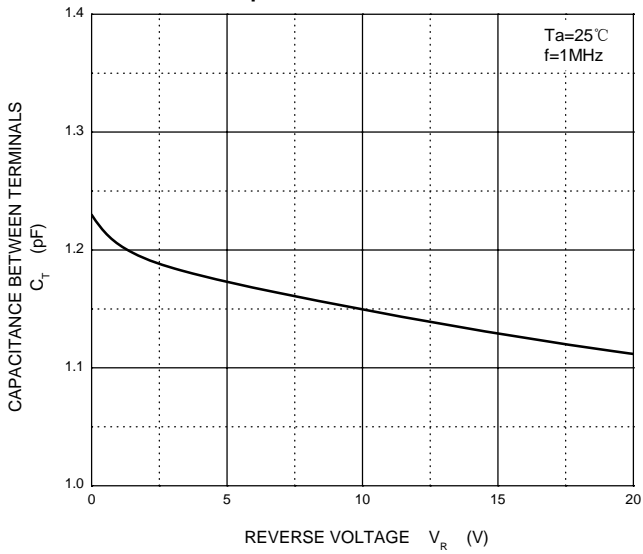

Power Derating Curve

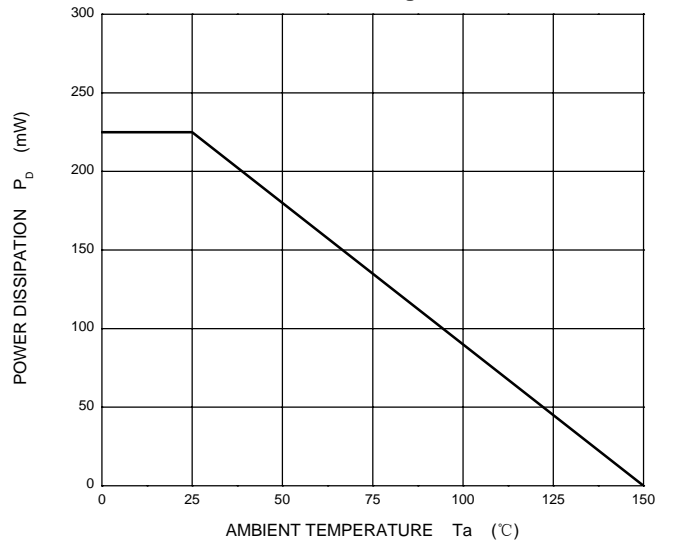

## Outline Drawing

### SOT-23 Package Outline Dimensions

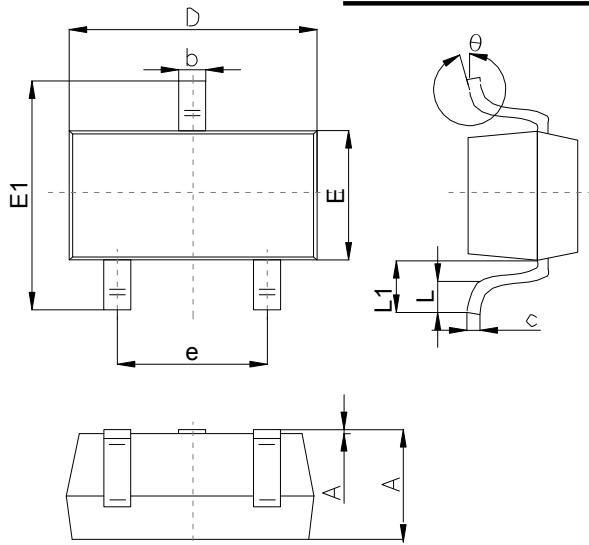

Symbol	Dimensions In Millimeters		
	Min	Typ	Max
A	0.90		1.40
A1	0.00		0.10
b	0.30		0.50
c	0.08		0.20
D	2.80	2.90	3.10
E	1.20		1.60
E1	2.25		2.80
e	1.80	1.90	2.00
L	0.10		0.50
L1	0.4		0.55
θ	0°		10°

### Suggested Pad Layout

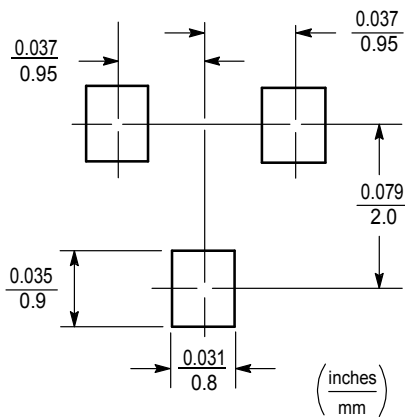

#### Note:

1. Controlling dimension:in/millimeters.
2. General tolerance: ±0.05mm.
3. The pad layout is for reference purposes only.

## SOT-23 Tape and Reel

### SOT-23 Embossed Carrier Tape

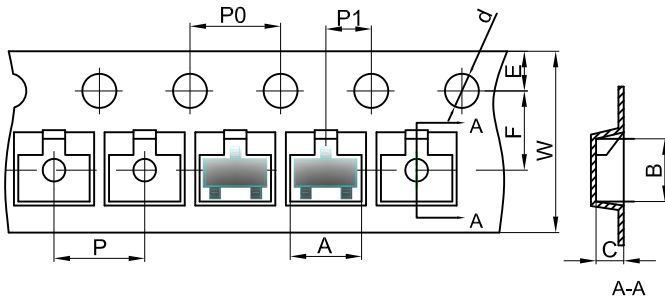

**Packaging Description:**

SOT-23 parts are shipped in tape. The carrier tape is made from a dissipative (carbon filled) polycarbonate resin. The cover tape is a multilayer film (Heat Activated Adhesive in nature) primarily composed of polyester film, adhesive layer, sealant, and anti-static sprayed agent. These reeled parts in standard option are shipped with 3,000 units per 7" or 17.8cm diameter reel. The reels are clear in color and is made of polystyrene plastic (anti-static coated).

Dimensions are in millimeter										
Pkg type	A	B	C	d	E	F	P0	P	P1	W
SOT-23	3.15	2.77	1.22	Ø1.50	1.75	3.50	4.00	4.00	2.00	8.00

### SOT-23 Tape Leader and Trailer

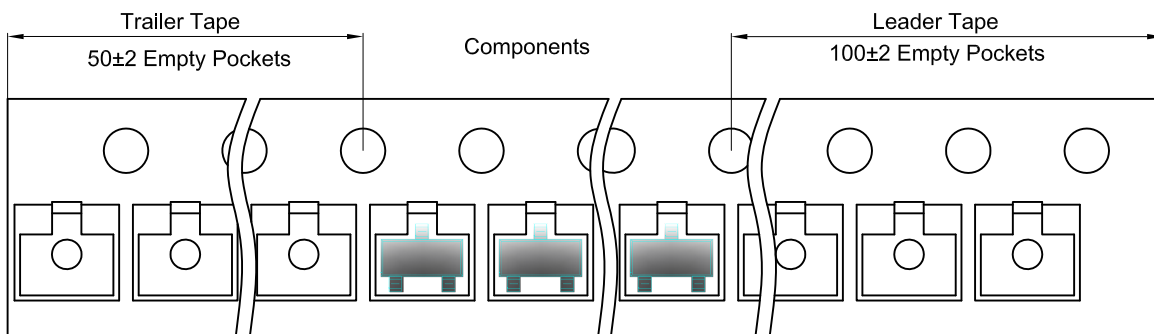

### SOT-23 Reel

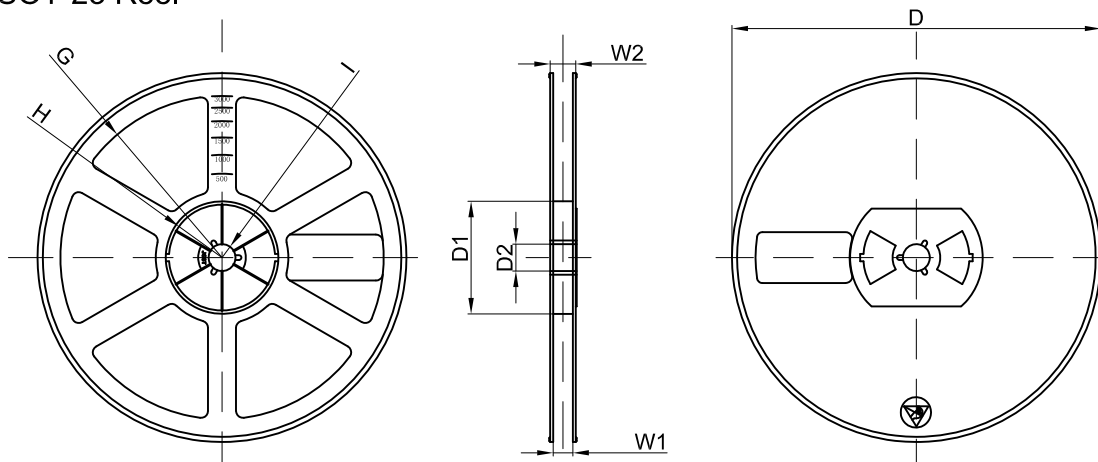

Dimensions are in millimeter								
Reel Option	D	D1	D2	G	H	I	W1	W2
7" Dia	Ø178.00	54.40	13.00	R78.00	R25.60	R6.50	9.50	12.30

REEL	Reel Size	Box	Box Size(mm)	Carton	Carton Size(mm)	G.W.(kg)
3000 pcs	7 Inch	45,000 pcs	203×203×195	180,000 pcs	438×438×220	