

SN5-5501

Aliases (UALSN555010000)

KEMET, SN, AC Line Filters, Normal Mode, 0.08 mH

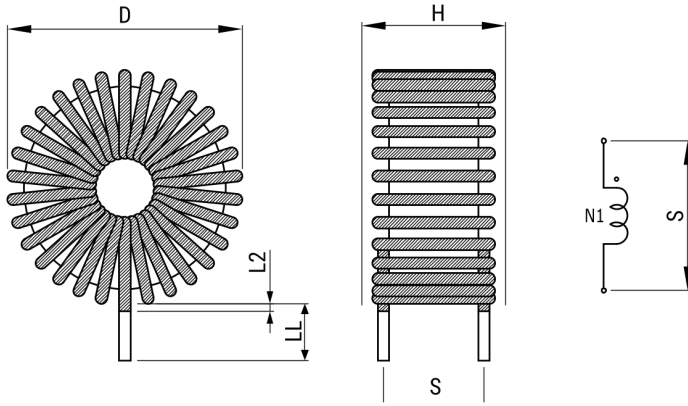

Click [here](#) for the 3D model.

General Information

Series	SN
Style	Through-Hole
Features	Compact Size
RoHS	Yes
Miscellaneous	Temperature Rise Maximum: 45 K.
Core	Fe

Specifications

Inductance	80 μ H (0.1MHz)
Current	1A
Temperature Range	-25/+105°C
DC Resistance	0.2 mOhms

Dimensions

D	13mm MAX
H	7mm MAX
LL	20mm +/-2mm
S	7mm NOM
L2	1.6mm MAX
Wire Size	0.4mm

Packaging Specifications

Packaging	Bulk
Component Weight	2.6 g

Statements of suitability for certain applications are based on our knowledge of typical operating conditions for such applications, but are not intended to constitute - and we specifically disclaim - any warranty concerning suitability for a specific customer application or use. This Information is intended for use only by customers who have the requisite experience and capability to determine the correct products for their application. Any technical advice inferred from this Information or otherwise provided by us with reference to the use of our products is given gratis, and we assume no obligation or liability for the advice given or results obtained.