



Parameters	Ratings	Units
Blocking Voltage	600	V_P
Load Current	150	mA_{rms} / mA_{DC}
On-Resistance (max)	22	Ω
LED Current to Operate	5	mA

Features

- PLA192E is 100% Tested for Partial Discharge: DIN EN 60747-5-5
- 5000V_{rms} Input/Output Isolation
- Low Drive Power Requirements (TTL/CMOS Compatible)
- No Moving Parts
- High Reliability
- Arc-Free With No Snubbing Circuits
- No EMI/RFI Generation
- Small 6-Pin Package
- Machine Insertable, Wave Solderable

Applications

- Instrumentation
 - Multiplexers
 - Data Acquisition
 - Electronic Switching
 - I/O Subsystems
- Meters (Watt-Hour, Water, Gas)
- Medical Equipment: Patient/Equipment Isolation
- Aerospace
- Industrial Controls

Pin Configuration

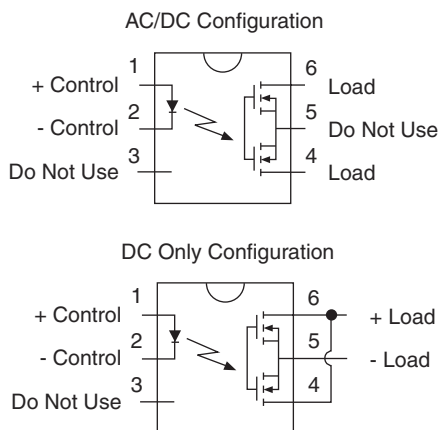

Description

IXYS Integrated Circuits Division's PLA192 is a single-pole, normally open (1-Form-A) solid state relay that provides 5000V_{rms} of input to output isolation.

In addition to all the features and benefits of the PLA192, the PLA192E meets the partial discharge demands of DIN EN 60747-5-5 (previously VDE 0884).

All versions of the PLA192 can be used to replace mechanical relays, while offering the superior reliability associated with semiconductor devices. Optically coupled outputs that use the patented OptoMOS architecture are controlled by a highly efficient GaAlAs infrared LED. Because they have no moving parts, they offer bounce-free switching in more compact surface mount or thru-hole packages.

Approvals

- UL Recognized Component: File E76270
- CSA Certified Component: Certificate 1175739
- EN/IEC 60950-1 Certified Component: TUV Certificate B 12 11 82667 002
- DIN EN 60747-5-5 Certified ("E" Suffix Only) VDE Certificate 40036603

Ordering Information

Part #	Description
PLA192E	6-Pin DIP (50/Tube)
PLA192ES	6-Pin Surface Mount (50/Tube)
PLA192ESTR	6-Pin Surface Mount (1000/Reel)
PLA192	6-Pin DIP (50/Tube)
PLA192S	6-Pin Surface Mount (50/Tube)
PLA192STR	6-Pin Surface Mount (1000/Reel)

Switching Characteristics of Normally Open Devices

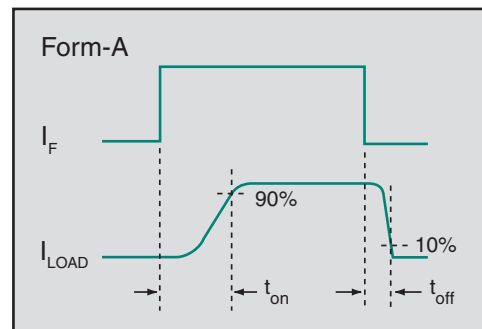

Absolute Maximum Ratings @ 25°C (Unless Otherwise Noted)

Parameter	Rating	Units
Blocking Voltage	600	V _P
Reverse Input Voltage	5	V
Input Control Current	50	mA
Peak (10ms)	1	A
Input Power Dissipation ¹	150	mW
Total Package Dissipation ²	800	mW
Isolation Voltage, Input to Output (60 Seconds)	5000	V _{rms}
ESD Rating, Human Body Model	4	kV
Operational Temperature	-40 to +85	°C
Storage Temperature	-40 to +125	°C

¹ Derate linearly 1.33 mW / °C

² Derate linearly 6.67 mW / °C

Absolute Maximum Ratings are stress ratings. Stresses in excess of these ratings can cause permanent damage to the device. Functional operation of the device at conditions beyond those indicated in the operational sections of this data sheet is not implied.

Electrical Characteristics @ 25°C (Unless Otherwise Noted)

Parameters	Conditions	Symbol	Min	Typ	Max	Units
Output Characteristics						
Load Current						
Continuous, AC/DC Configuration	-	I _L	-	-	150	mA _{rms} / mA _{DC}
Continuous, DC-Only Configuration	-	I _L	-	-	220	mA _{DC}
Peak	t=10ms	I _{LPK}	-	-	±400	mA _P
On-Resistance						
AC/DC Configuration	I _L =150mA	R _{ON}	-	13.3	22	Ω
DC-Only Configuration	I _L =220mA	R _{ON}	-	4.15	8	Ω
Off-State Leakage Current	V _L =600V _P	I _{LEAK}	-	-	1	μA
Switching Speeds						
Turn-On	I _F =5mA, V _L =10V	t _{on}	-	-	5	ms
Turn-Off		t _{off}	-	-	5	
Output Capacitance	V _L =50V, f=1MHz	C _{OUT}	-	10	-	pF
Input Characteristics						
Input Control Current to Activate	I _L =100mA	I _F	-	0.22	5	mA
Input Control Current to Deactivate	-	I _F	0.1	0.21	-	mA
Input Voltage Drop	I _F =5mA	V _F	0.9	1.2	1.4	V
Reverse Input Current	V _R =5V	I _R	-	-	10	μA
Common Characteristics						
Input to Output Capacitance	-	C _{I/O}	-	3	-	pF

PLA192E Safety and Insulation Ratings

Parameters	Conditions	Symbol	Min	Max	Units
Pollution Degree 2 according to DIN VDE 0109	-	-	-	-	-
Highest Allowable Over-Voltage	Transient Voltage	V _{IOTM}	7071	-	V _P
Maximum Working Insulation Voltage	Recurring Voltage	V _{IOORM}	1000	-	V _P
Partial Discharge Test Voltage	DIN EN 60747-5-5 Method B	V _{PR}	-	1875	V _P
Isolation Test Voltage	-	V _{ISO}	-	5000	V _{rms}
Creepage Distance	-	-	7.6	-	mm
Clearance Distance	-	-	7.6	-	mm

PERFORMANCE DATA (@ 25°C Unless Otherwise Noted)*

Typical LED Forward Voltage Drop
(N=50, I_F=5mA)

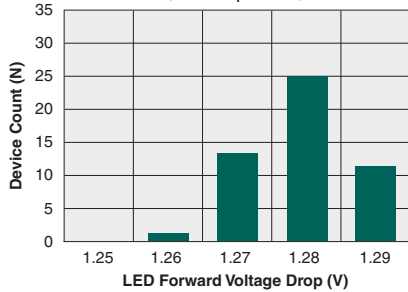

Typical Turn-On Time
(N=50, I_F=5mA, I_L=100mA_{DC})

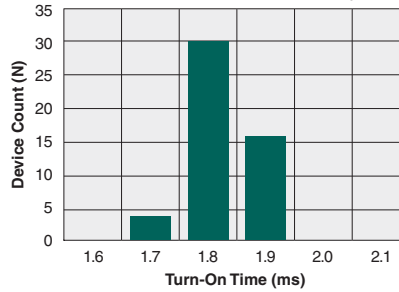

Typical Turn-Off Time
(N=50, I_F=5mA, I_L=100mA_{DC})

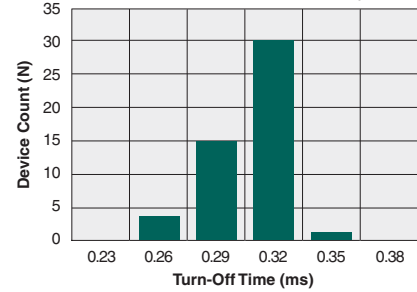

Typical I_F for Switch Operation
(N=50, I_L=100mA)

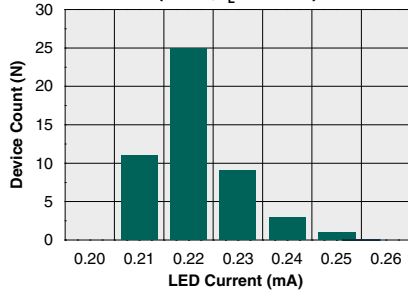

Typical On-Resistance Distribution
(N=50, I_F=5mA, I_L=150mA)

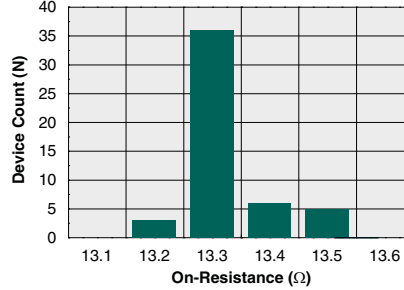

DC-Only On-Resistance Distribution
(N=50, I_F=5mA, I_L=220mA)

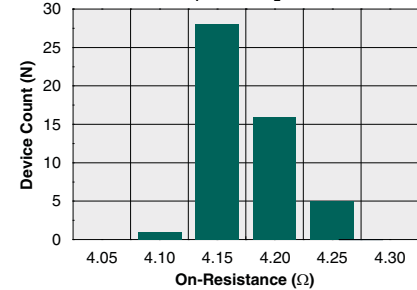

Typical Blocking Voltage Distribution
(N=50)

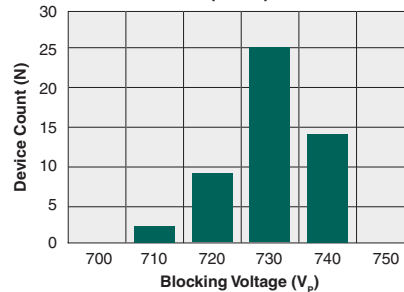

Typical LED Forward Voltage Drop vs. Temperature

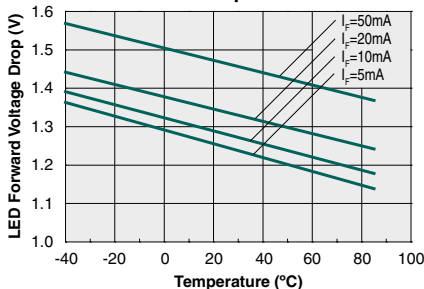

Typical Turn-On Time vs. LED Forward Current
(I_L=100mA)

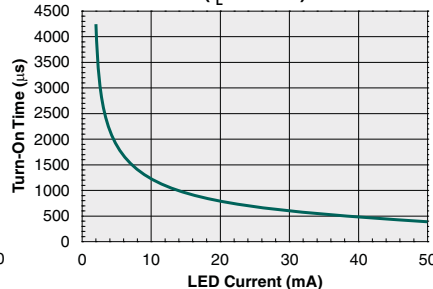

Typical Turn-Off Time vs. LED Forward Current
(I_L=100mA)

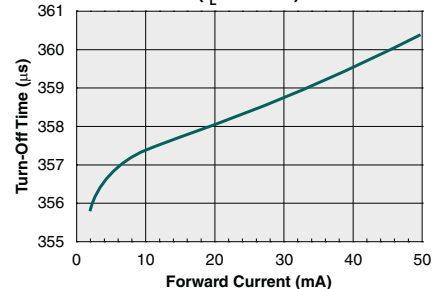

*The Performance data shown in the graphs above is typical of device performance. For guaranteed parameters not indicated in the written specifications, please contact our application department.

PERFORMANCE DATA (@ 25°C Unless Otherwise Noted)*

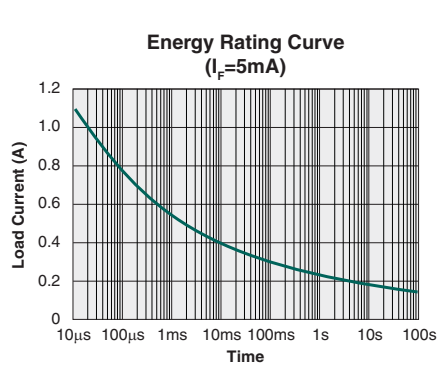
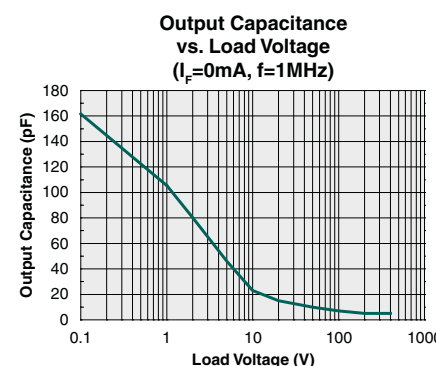
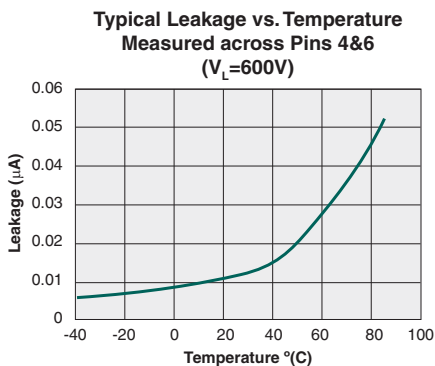
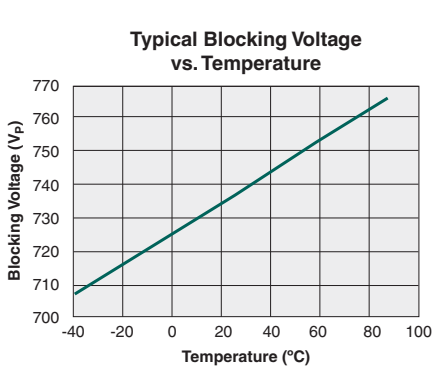
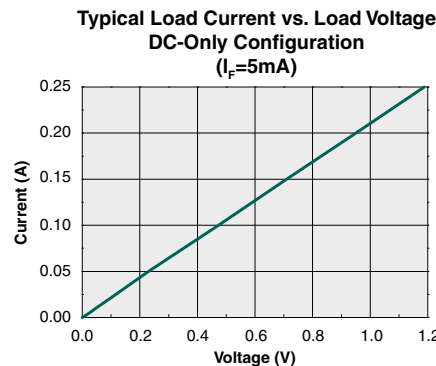
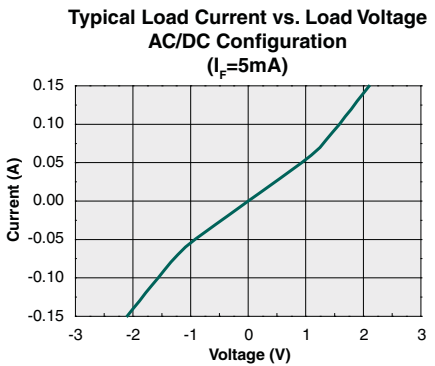
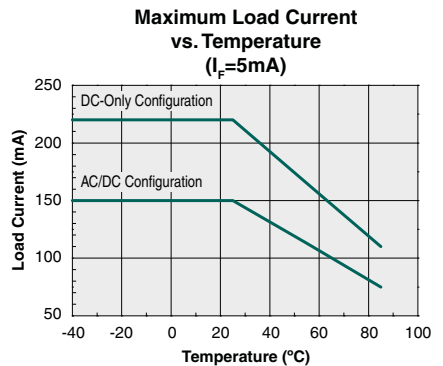
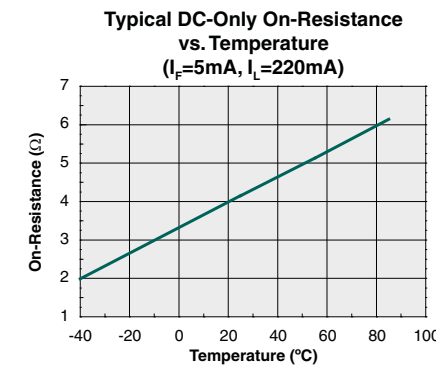
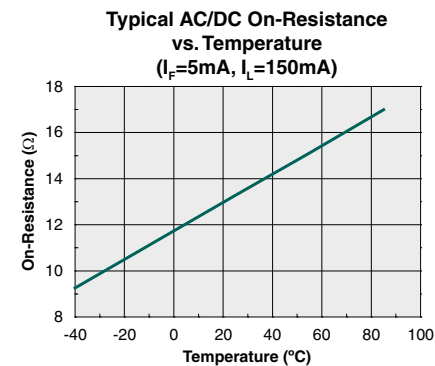
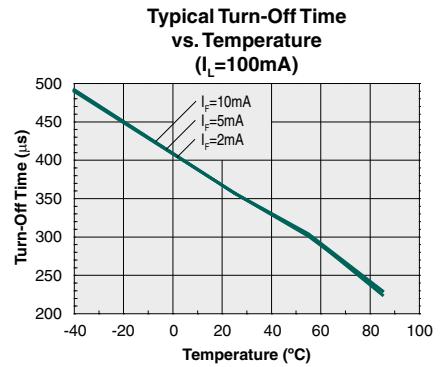
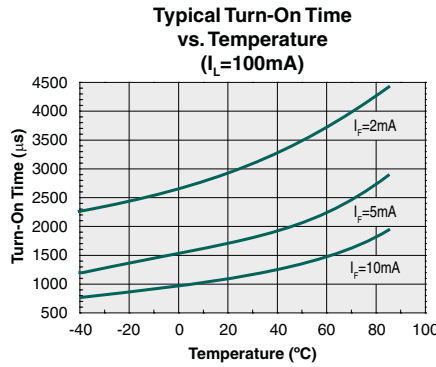
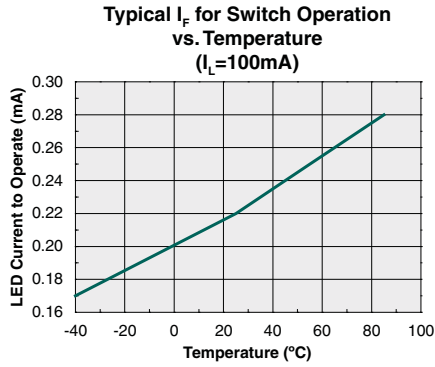

*The Performance data shown in the graphs above is typical of device performance. For guaranteed parameters not indicated in the written specifications, please contact our application department.

Manufacturing Information

Moisture Sensitivity



All plastic encapsulated semiconductor packages are susceptible to moisture ingress. IXYS Integrated Circuits Division classified all of its plastic encapsulated devices for moisture sensitivity according to the latest version of the joint industry standard, **IPC/JEDEC J-STD-020**, in force at the time of product evaluation. We test all of our products to the maximum conditions set forth in the standard, and guarantee proper operation of our devices when handled according to the limitations and information in that standard as well as to any limitations set forth in the information or standards referenced below.

Failure to adhere to the warnings or limitations as established by the listed specifications could result in reduced product performance, reduction of operable life, and/or reduction of overall reliability.

This product carries a **Moisture Sensitivity Level (MSL) rating** as shown below, and should be handled according to the requirements of the latest version of the joint industry standard **IPC/JEDEC J-STD-033**.

Device	Moisture Sensitivity Level (MSL) Rating
All Versions	MSL 1

ESD Sensitivity



This product is **ESD Sensitive**, and should be handled according to the industry standard **JESD-625**.

Reflow Profile

This product has a maximum body temperature and time rating as shown below. All other guidelines of **J-STD-020** must be observed.

Device	Maximum Temperature x Time
All Versions	250°C for 30 seconds

Board Wash

IXYS Integrated Circuits Division recommends the use of no-clean flux formulations. However, board washing to remove flux residue is acceptable. IXYS Integrated Circuits Division employs the use of silicone coating as an optical waveguide in the standard PLA192 (without the "E" suffix); the use of a short drying bake could be necessary if a wash is used after solder reflow processes. The E-suffix product, being of double-molded construction, does not have the same necessity for a drying bake. Chlorine- or Fluorine-based solvents or fluxes should not be used. Cleaning methods that employ ultrasonic energy should not be used.



PLA192STR & PLA192ESTR Tape & Reel

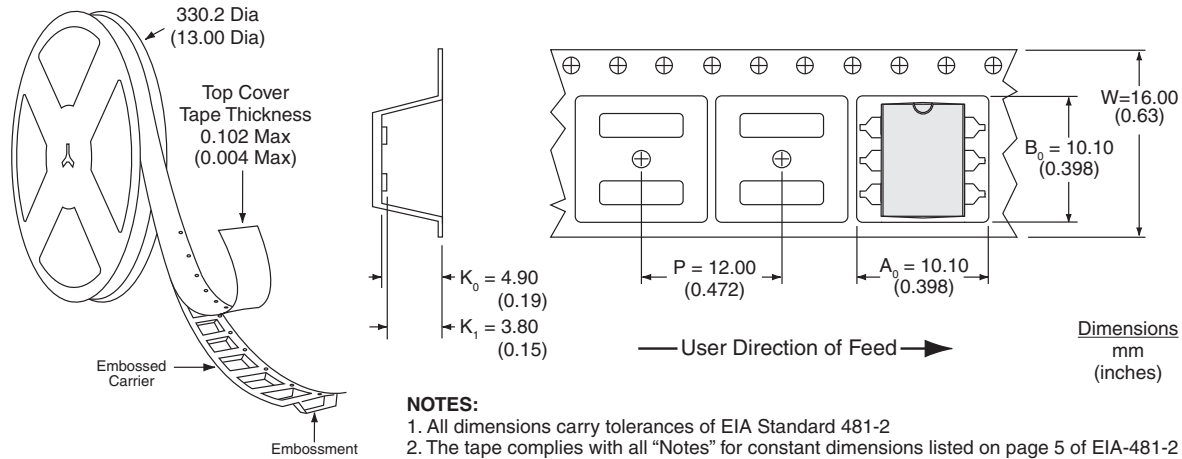

For additional information please visit our website at: www.ixysic.com

IXYS Integrated Circuits Division makes no representations or warranties with respect to the accuracy or completeness of the contents of this publication and reserves the right to make changes to specifications and product descriptions at any time without notice. Neither circuit patent licenses nor indemnity are expressed or implied. Except as set forth in IXYS Integrated Circuits Division's Standard Terms and Conditions of Sale, IXYS Integrated Circuits Division assumes no liability whatsoever, and disclaims any express or implied warranty, relating to its products including, but not limited to, the implied warranty of merchantability, fitness for a particular purpose, or infringement of any intellectual property right.

The products described in this document are not designed, intended, authorized or warranted for use as components in systems intended for surgical implant into the body, or in other applications intended to support or sustain life, or where malfunction of IXYS Integrated Circuits Division's product may result in direct physical harm, injury, or death to a person or severe property or environmental damage. IXYS Integrated Circuits Division reserves the right to discontinue or make changes to its products at any time without notice.