

High Efficiency Standard Rectifier

1~ Rectifier
$V_{RRM} = 1200\text{ V}$
$I_{DAV} = 124\text{ A}$
$I_{FSM} = 400\text{ A}$

1~ Rectifier Bridge

Part number

DLA100B1200LB

Marking on Product: *DLA100B1200LB*

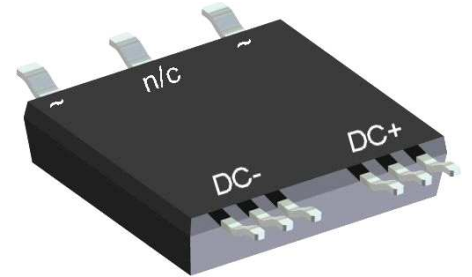

Backside: isolated

 E72873

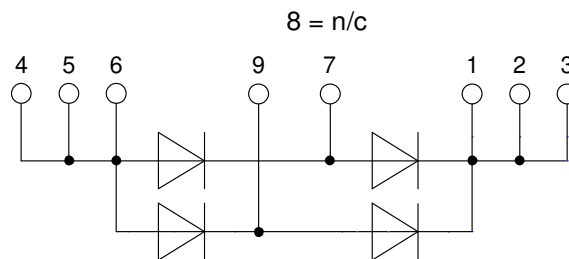

Features / Advantages:

- Planar passivated chips
- Very low leakage current
- Very low forward voltage drop
- Improved thermal behaviour

Applications:

- Diode Bridge for main rectification

Package: SMPD

- Isolation Voltage: 3000 V~
- Industry convenient outline
- RoHS compliant
- Epoxy meets UL 94V-0
- Soldering pins for PCB mounting
- Backside: DCB ceramic
- Reduced weight
- Advanced power cycling

Disclaimer Notice

Information furnished is believed to be accurate and reliable. However, users should independently evaluate the suitability of and test each product selected for their own applications. Littelfuse products are not designed for, and may not be used in, all applications. Read complete Disclaimer Notice at www.littelfuse.com/disclaimer-electronics.



Rectifier				Ratings			
Symbol	Definition	Conditions	min.	typ.	max.	Unit	
V_{RSM}	max. non-repetitive reverse blocking voltage	$T_{VJ} = 25^{\circ}C$			1200	V	
V_{RRM}	max. repetitive reverse blocking voltage	$T_{VJ} = 25^{\circ}C$			1200	V	
I_R	reverse current	$V_R = 1200 V$	$T_{VJ} = 25^{\circ}C$		10	μA	
		$V_R = 1200 V$	$T_{VJ} = 150^{\circ}C$		0.1	mA	
V_F	forward voltage drop	$I_F = 50 A$	$T_{VJ} = 25^{\circ}C$		1.23	V	
		$I_F = 100 A$			1.45	V	
		$I_F = 50 A$	$T_{VJ} = 150^{\circ}C$		1.15	V	
		$I_F = 100 A$			1.44	V	
I_{DAV}	bridge output current	$T_C = 135^{\circ}C$ 180° sine	$T_{VJ} = 175^{\circ}C$		124	A	
V_{FO}	threshold voltage	} for power loss calculation only	$T_{VJ} = 175^{\circ}C$		0.75	V	
r_F	slope resistance				4.2	m Ω	
R_{thJC}	thermal resistance junction to case				1	K/W	
R_{thCH}	thermal resistance case to heatsink			0.40		K/W	
P_{tot}	total power dissipation		$T_C = 25^{\circ}C$		150	W	
I_{FSM}	max. forward surge current	t = 10 ms; (50 Hz), sine	$T_{VJ} = 45^{\circ}C$		400	A	
		t = 8,3 ms; (60 Hz), sine	$V_R = 0 V$		430	A	
		t = 10 ms; (50 Hz), sine	$T_{VJ} = 150^{\circ}C$		340	A	
		t = 8,3 ms; (60 Hz), sine	$V_R = 0 V$		365	A	
I^2t	value for fusing	t = 10 ms; (50 Hz), sine	$T_{VJ} = 45^{\circ}C$		800	A ² s	
		t = 8,3 ms; (60 Hz), sine	$V_R = 0 V$		770	A ² s	
		t = 10 ms; (50 Hz), sine	$T_{VJ} = 150^{\circ}C$		580	A ² s	
		t = 8,3 ms; (60 Hz), sine	$V_R = 0 V$		555	A ² s	
C_J	junction capacitance	$V_R = 400 V; f = 1 MHz$	$T_{VJ} = 25^{\circ}C$		13	pF	



Package SMPD		Ratings				
Symbol	Definition	Conditions	min.	typ.	max.	Unit
I_{RMS}	RMS current	per terminal			100	A
T_{VJ}	virtual junction temperature		-55		175	°C
T_{op}	operation temperature		-55		150	°C
T_{stg}	storage temperature		-55		150	°C
Weight				8.5		g
F_C	mounting force with clip		40		130	N
$d_{Spp/ App}$	creepage distance on surface / striking distance through air	terminal to terminal	1.6			mm
$d_{Spb/ Apb}$		terminal to backside	4.0			mm
V_{ISOL}	isolation voltage	t = 1 second	3000			V
		t = 1 minute	2500			V

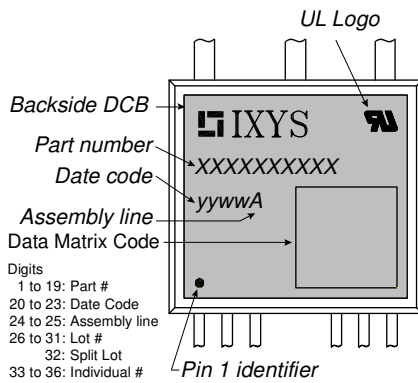

Part description

- D = Diode
- L = Low Voltage Standard Rectifier
- A = (up to 1200V)
- 100 = Current Rating [A]
- B = 1~ Rectifier Bridge
- 1200 = Reverse Voltage [V]
- LB = SMPD-B

Ordering	Ordering Number	Marking on Product	Delivery Mode	Quantity	Code No.
Standard	DLA100B1200LB-TUB	DLA100B1200LB	Tube	20	517180
Alternative	DLA100B1200LB-TRR	DLA100B1200LB	Tape & Reel	200	517187

Equivalent Circuits for Simulation

* on die level

$T_{VJ} = 175\text{ °C}$

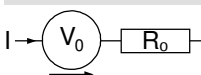

Rectifier

$V_{0\ max}$	threshold voltage	0.51	V
$R_{0\ max}$	slope resistance *	1.3	mΩ

Rectifier

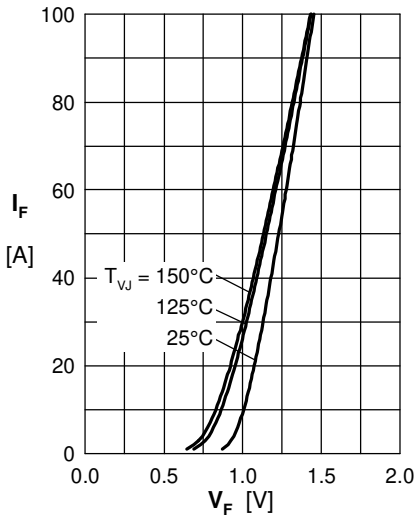

Fig. 1 Forward current versus voltage drop per diode

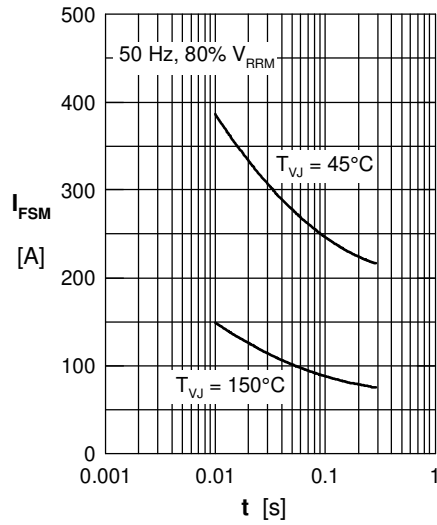

Fig. 2 Surge overload current

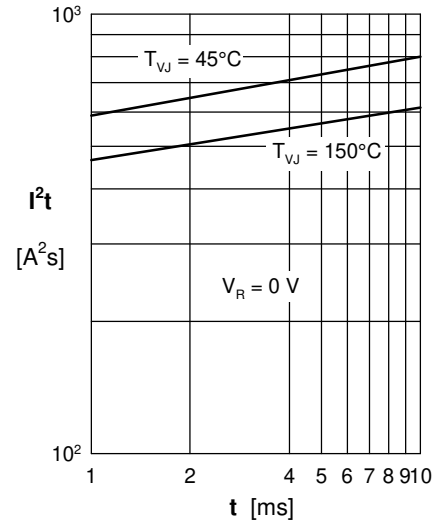

Fig. 3 I^2t versus time per diode

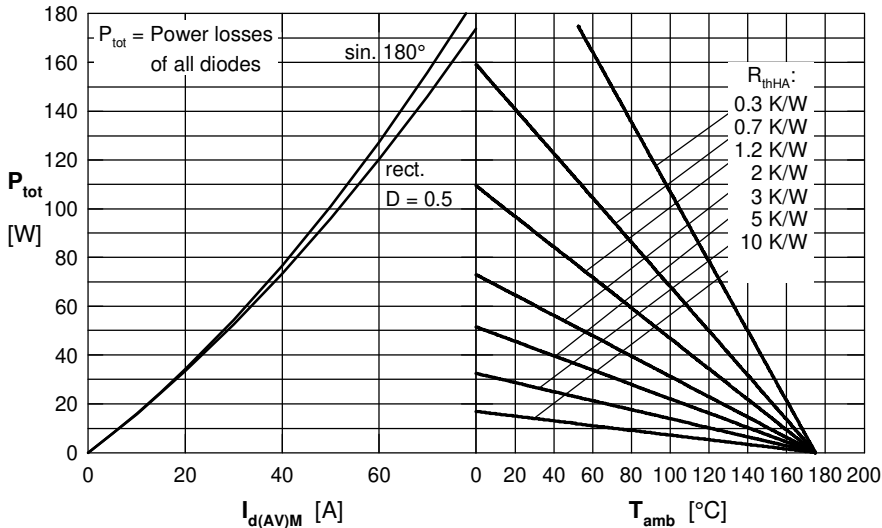

Fig. 4 Power dissipation vs. bridge output current and ambient temperature

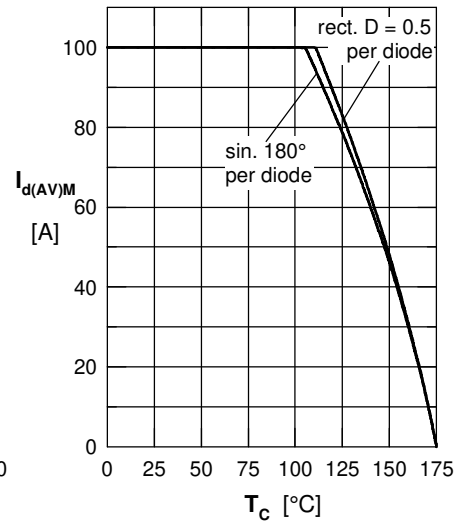

Fig. 5 Max. bridge output current vs. case temperature

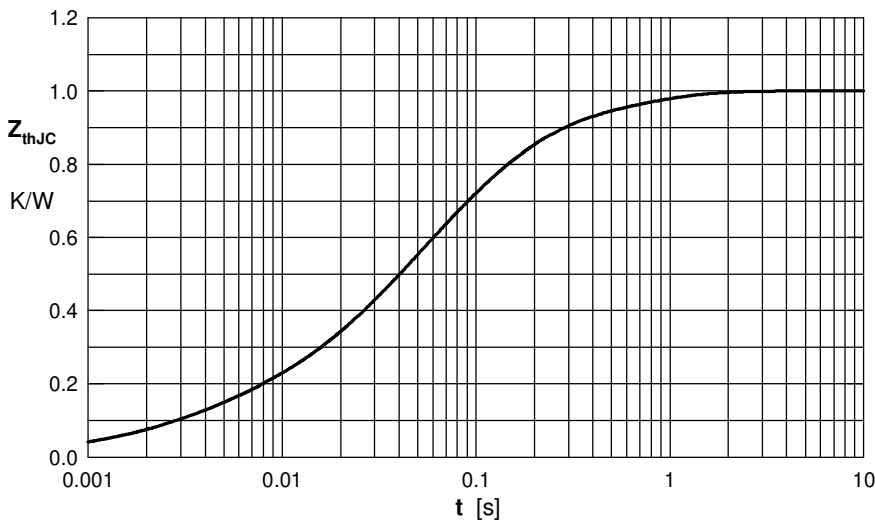

Fig. 6 Transient thermal impedance junction to case

Constants for Z_{thJC} calculation:

i	R_{thi} [K/W]	t_i [s]
1	0.09	0.003
2	0.116	0.062
3	0.386	0.1
4	0.128	0.55