

HiPerFRED²

V_{RRM}	=	400V
I_{FAV}	=	30A
t_{rr}	=	45ns

High Performance Fast Recovery Diode
 Low Loss and Soft Recovery
 Single Diode

Part number

DPG30I400HA

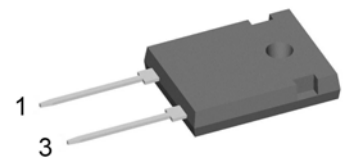

Backside: cathode

**Features / Advantages:**

- Planar passivated chips
- Very low leakage current
- Very short recovery time
- Improved thermal behaviour
- Very low I_{rm} -values
- Very soft recovery behaviour
- Avalanche voltage rated for reliable operation
- Soft reverse recovery for low EMI/RFI
- Low I_{rm} reduces:
 - Power dissipation within the diode
 - Turn-on loss in the commutating switch

Applications:

- Antiparallel diode for high frequency switching devices
- Antisaturation diode
- Snubber diode
- Free wheeling diode
- Rectifiers in switch mode power supplies (SMPS)
- Uninterruptible power supplies (UPS)

Package: TO-247

- Industry standard outline
- RoHS compliant
- Epoxy meets UL 94V-0

Fast Diode				Ratings		
Symbol	Definition	Conditions	min.	typ.	max.	Unit
V_{RSM}	max. non-repetitive reverse blocking voltage	$T_{VJ} = 25^{\circ}C$			400	V
V_{RRM}	max. repetitive reverse blocking voltage	$T_{VJ} = 25^{\circ}C$			400	V
I_R	reverse current, drain current	$V_R = 400 V$	$T_{VJ} = 25^{\circ}C$		1	μA
		$V_R = 400 V$	$T_{VJ} = 150^{\circ}C$		0.2	mA
V_F	forward voltage drop	$I_F = 30 A$	$T_{VJ} = 25^{\circ}C$		1.41	V
					1.69	V
		$I_F = 60 A$	$T_{VJ} = 150^{\circ}C$		1.13	V
					1.46	V
I_{FAV}	average forward current	$T_C = 135^{\circ}C$ rectangular $d = 0.5$	$T_{VJ} = 175^{\circ}C$		30	A
V_{FO}	threshold voltage	} for power loss calculation only	$T_{VJ} = 175^{\circ}C$		0.76	V
r_F	slope resistance				10.7	m Ω
R_{thJC}	thermal resistance junction to case				0.95	K/W
R_{thCH}	thermal resistance case to heatsink			0.25		K/W
P_{tot}	total power dissipation		$T_C = 25^{\circ}C$		160	W
I_{FSM}	max. forward surge current	$t = 10 ms; (50 Hz), sine; V_R = 0 V$	$T_{VJ} = 45^{\circ}C$		360	A
C_J	junction capacitance	$V_R = 200 V f = 1 MHz$	$T_{VJ} = 25^{\circ}C$		32	pF
I_{RM}	max. reverse recovery current	} $I_F = 30 A; V_R = 270 V$ $-di_F/dt = 200 A/\mu s$	$T_{VJ} = 25^{\circ}C$		4	A
t_{rr}	reverse recovery time		$T_{VJ} = 125^{\circ}C$		8.5	A
			$T_{VJ} = 25^{\circ}C$		45	ns
			$T_{VJ} = 125^{\circ}C$		85	ns

Package TO-247			Ratings			
Symbol	Definition	Conditions	min.	typ.	max.	Unit
I_{RMS}	RMS current	per terminal			50	A
T_{VJ}	virtual junction temperature		-55		175	°C
T_{op}	operation temperature		-55		150	°C
T_{stg}	storage temperature		-55		150	°C
Weight				6		g
M_D	mounting torque		0.8		1.2	Nm
F_C	mounting force with clip		20		120	N

Product Marking

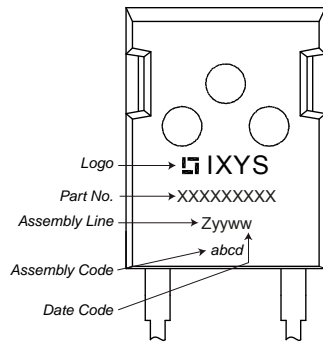

Part number

- D = Diode
- P = HiPerFRED
- G = extreme fast
- 30 = Current Rating [A]
- I = Single Diode
- 400 = Reverse Voltage [V]
- HA = TO-247AD (2)

Ordering	Part Number	Marking on Product	Delivery Mode	Quantity	Code No.
Standard	DPG30I400HA	DPG30I400HA	Tube	30	507320

Equivalent Circuits for Simulation

* on die level

$T_{VJ} = 175\text{ °C}$

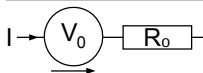

Fast Diode

$V_{0\max}$	threshold voltage	0.76	V
$R_{0\max}$	slope resistance *	8.1	mΩ

Outlines TO-247

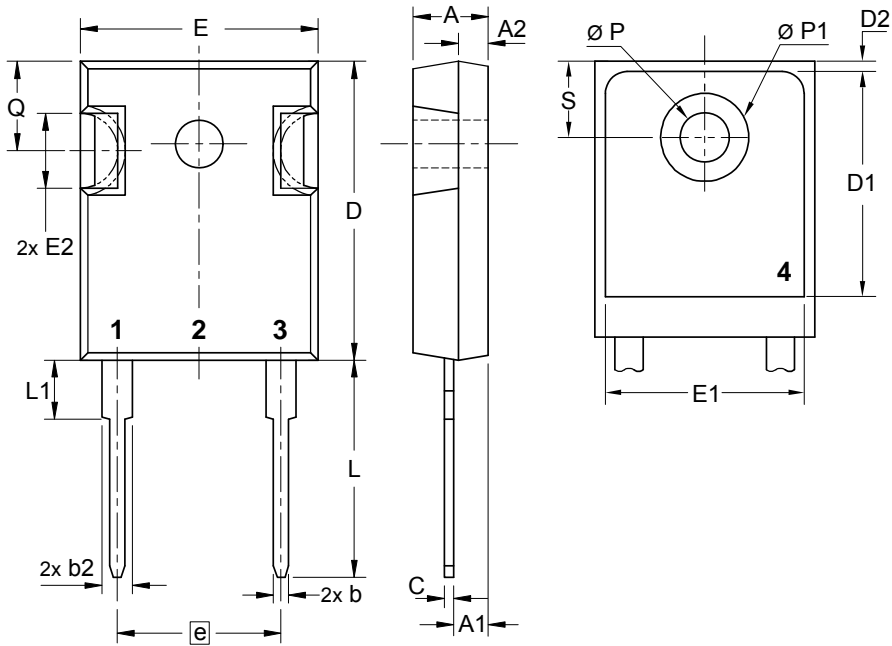

Sym.	Inches		Millimeter	
	min.	max.	min.	max.
A	0.185	0.209	4.70	5.30
A1	0.087	0.102	2.21	2.59
A2	0.059	0.098	1.50	2.49
D	0.819	0.845	20.79	21.45
E	0.610	0.640	15.48	16.24
E2	0.170	0.216	4.31	5.48
e	0.430 BSC		10.92 BSC	
L	0.780	0.800	19.80	20.30
L1	-	0.177	-	4.49
Ø P	0.140	0.144	3.55	3.65
Q	0.212	0.244	5.38	6.19
S	0.242 BSC		6.14 BSC	
b	0.039	0.055	0.99	1.40
b2	0.065	0.094	1.65	2.39
b4	0.102	0.135	2.59	3.43
c	0.015	0.035	0.38	0.89
D1	0.515	-	13.07	-
D2	0.020	0.053	0.51	1.35
E1	0.530	-	13.45	-
Ø P1	-	0.29	-	7.39



Fast Diode

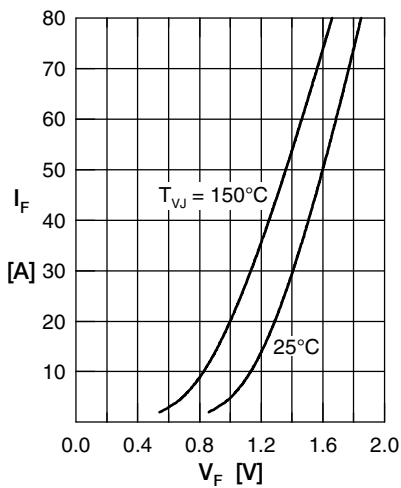

Fig. 1 Forward current I_F versus V_F

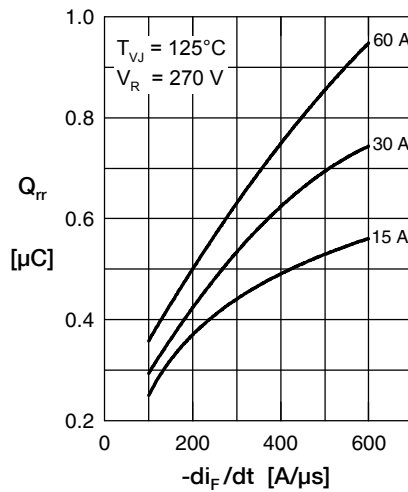

Fig. 2 Typ. reverse recov. charge Q_{rr} versus $-di_F/dt$

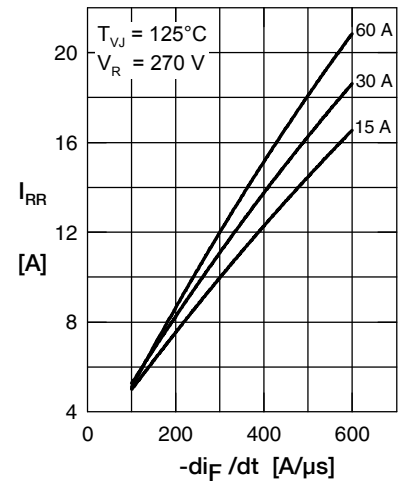

Fig. 3 Typ. reverse recovery current I_{RR} versus $-di_F/dt$

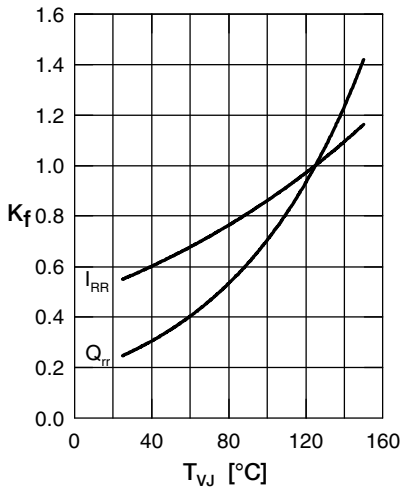

Fig. 4 Typ. dynamic parameters Q_{rr} , I_{RR} versus T_{VJ}

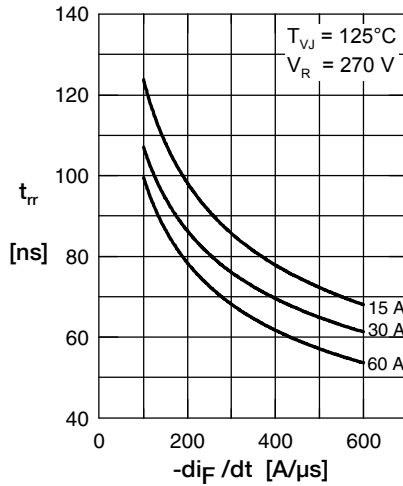

Fig. 5 Typ. reverse recov. time t_{rr} versus $-di_F/dt$

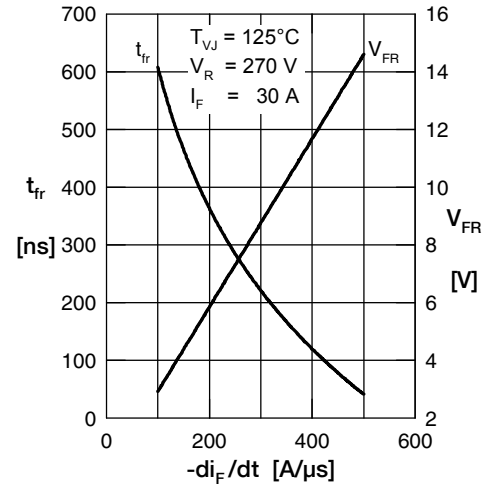

Fig. 6 Typ. forward recov. voltage V_{FR} & time t_{fr} versus di_F/dt

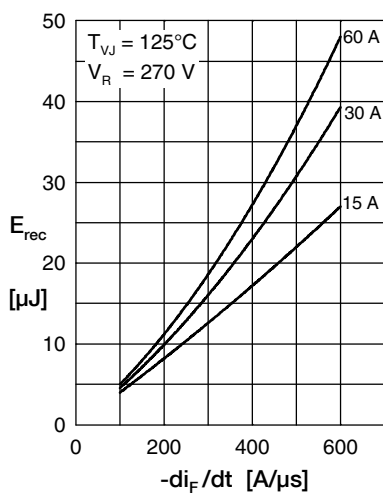

Fig. 7 Typ. recovery energy E_{rec} versus $-di_F/dt$

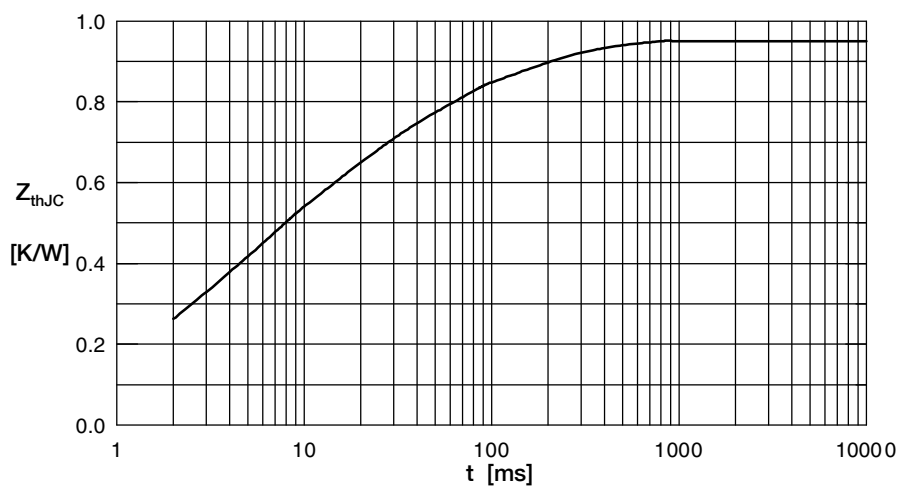

Fig. 8 Transient thermal impedance junction to case