

Aluminum Electrolytic Capacitors Axial Standard, High Voltage

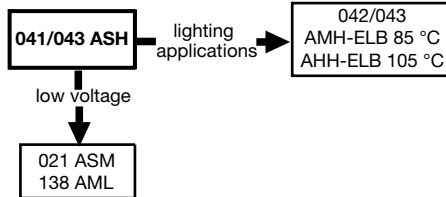

Fig. 1

QUICK REFERENCE DATA	
DESCRIPTION	VALUE
Nominal case sizes (\varnothing D x L in mm)	8 x 18 to 10 x 25 10 x 30 to 21 x 38
Rated capacitance range, C_R	6.8 μ F to 220 μ F
Tolerance on C_R	-10 % to +50 %
Rated voltage range, U_R	160 V to 450 V
Category temperature range	-40 °C to +85 °C (450 V: -25 °C to +85 °C)
Endurance test at 85 °C	2000 h 8000 h (450 V: 5000 h)
Useful life at 85 °C	5000 h 15 000 h (450 V: 10 000 h)
Useful life at 40 °C	1.4 x I_R applied: 120 000 h 1.8 x I_R applied: 240 000 h (450 V: 160 000 h)
Shelf life at 0 V, 85 °C	500 h
Based on sectional specification	IEC 60384-4 / EN130300
Climatic category IEC 60068	40 / 085 / 56 (450 V: 25 / 085 / 56)

FEATURES

- Useful life: 5000 h to 15 000 h at 85 °C
- High rated voltage: up to 450 V
- Taped versions up to case \varnothing 15 mm x 30 mm available for automatic insertion
- Polarized aluminum electrolytic capacitors, non-solid electrolyte
- Axial leads, cylindrical aluminum case, insulated with a blue sleeve
- Mounting ring version not available in insulated form
- Material categorization: for definitions of compliance please see www.vishay.com/doc?99912

**RoHS
COMPLIANT**

APPLICATIONS

- General purpose, industrial, power supply, audio-video
- Smoothing, filtering, buffering at high voltages
- Boards with restricted mounting height, vibration, and shock resistant

MARKING

The capacitors are marked (where possible) with the following information:

- Rated capacitance (in μ F)
- Tolerance on rated capacitance, code letter in accordance with IEC 60062 (T for -10 % to +50 %)
- Rated voltage (in V)
- Upper category temperature (85 °C)
- Date code, in accordance with IEC 60062
- Code indicating factory of origin
- Name of manufacturer
- Negative terminal identification
- Series number (041, 042 or 043)

SELECTION CHART FOR C_R , U_R , AND RELEVANT NOMINAL CASE SIZES (\varnothing D x L in mm)						
C_R (μ F)	U_R (V)					
	160	250	350	385	400	450
6.8	-	-	10 x 30	10 x 30	10 x 30	10 x 30
10	8 x 18	-	12.5 x 30	12.5 x 30	12.5 x 30	12.5 x 30
	-	10 x 30	-	-	-	-
15	-	12.5 x 30	12.5 x 30	15 x 30	15 x 30	12.5 x 30
22	10 x 25	12.5 x 30	15 x 30	18 x 30	18 x 30	15 x 30
	10 x 30	-	-	-	-	-
33	12.5 x 30	15 x 30	18 x 30	18 x 38	18 x 38	18 x 30
47	15 x 30	18 x 30	18 x 38	18 x 38	18 x 38	18 x 38
68	15 x 30	18 x 38	21 x 38	21 x 38	21 x 38	21 x 38
100	18 x 30	21 x 38	-	-	-	-
150	18 x 38	-	-	-	-	-
220	21 x 38	-	-	-	-	-

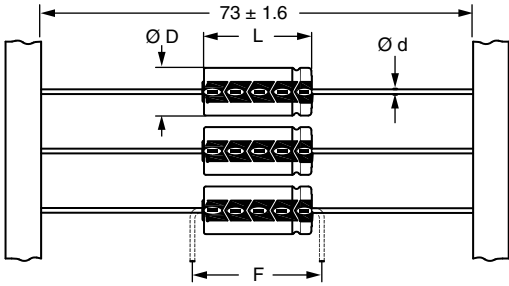
DIMENSIONS in millimeters AND AVAILABLE FORMS

Form BR: Taped on reel
Case $\text{Ø D} \times \text{L} = 8 \text{ mm} \times 18 \text{ mm} \times 15 \text{ mm} \times 30 \text{ mm}$
Form BA: Taped in box (ammopack)
Case $\text{Ø D} \times \text{L} = 8 \text{ mm} \times 18 \text{ mm} \times 10 \text{ mm} \times 25 \text{ mm}$

Fig. 2 - Forms BA and BR

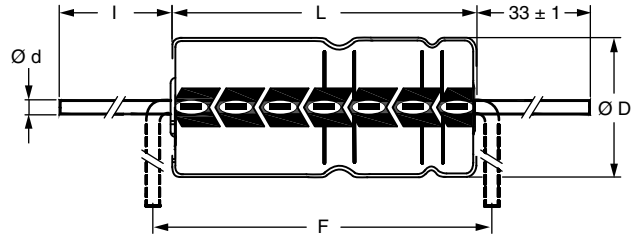

Form AA: Axial in box
Case $\text{Ø D} \times \text{L} = 10 \text{ mm} \times 30 \text{ mm} \times 21 \text{ mm} \times 38 \text{ mm}$

Fig. 3 - Form AA

Table 1

AXIAL; DIMENSIONS in millimeters, MASS AND PACKAGING QUANTITIES										
NOMINAL CASE SIZE $\text{Ø D} \times \text{L}$	CASE CODE	AXIAL: FORM AA, BA, AND BR					MASS (g)	PACKAGING QUANTITIES		
		Ø d	l	$\text{Ø D}_{\text{max.}}$	$L_{\text{max.}}$	$F_{\text{min.}}$		FORM AA	FORM BA	FORM BR
8 x 18	5	0.8	-	8.5	18.5	25	≈ 1.7	-	500	500
10 x 18	6	0.8	-	10.5	18.5	25	≈ 2.5	-	500	500
10 x 25	7	0.8	-	10.5	25.5	30	≈ 3.3	-	500	500
10 x 30	00	0.8	55 ± 1	10.5	30.5	35	≈ 4.8	340	-	500
12.5 x 30	01	0.8	55 ± 1	13.0	30.5	35	≈ 7.4	260	-	400
15 x 30	02	0.8	55 ± 1	15.5	30.5	35	≈ 11.7	200	-	250
18 x 30	03	0.8	55 ± 1	18.5	30.5	35	≈ 12.9	120	-	-
18 x 38	04	0.8	34 ± 1	18.5	39.5	44	≈ 19.0	125	-	-
21 x 38	05	0.8	34 ± 1	21.5	39.5	44	≈ 24.0	100	-	-

Note

- For detailed tape dimensions please refer to packaging information: www.vishay.com/doc?28361

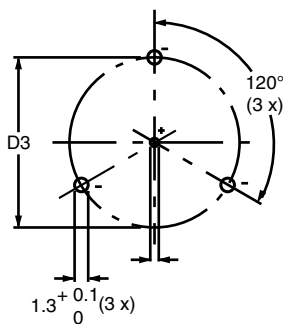

Form MR:
Case $\text{Ø D} \times \text{L} = 15 \text{ mm} \times 30 \text{ mm} \text{ to } 21 \text{ mm} \times 38 \text{ mm}$
Especially for applications with severe shocks and vibrations

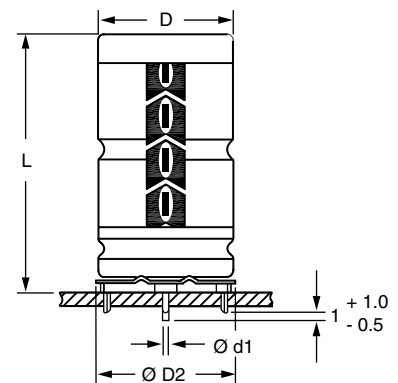
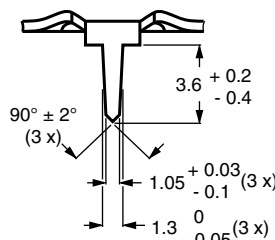

 Fig. 4 - Mounting hole diagram and outline. **Form MR:** With mounting ring and pins

Table 2

MOUNTING RING; DIMENSIONS in millimeters, MASS AND PACKAGING QUANTITIES									
NOMINAL CASE SIZE $\text{Ø D} \times \text{L}$	CASE CODE	MOUNTING RING: FORM MR						MASS (g)	PACKAGING QUANTITIES
		Ø d1	Ø d2	$\text{Ø D}_{\text{max.}}$	$\text{Ø D2}_{\text{max.}}$	D3	$L_{\text{max.}}$		
15 x 30	02	0.8	$1.0 + 0.4$	15.5	17.5	16.5 ± 0.2	33	≈ 11.7	200
18 x 30	03	0.8	$1.0 + 0.4$	18.5	19.5	18.5 ± 0.2	33	≈ 12.9	240
18 x 38	04	0.8	$1.0 + 0.4$	18.5	19.5	18.5 ± 0.2	42	≈ 19.0	100
21 x 38	05	0.8	$1.0 + 0.4$	21.5	22.5	21.5 ± 0.2	42	≈ 24.0	100



ELECTRICAL DATA	
SYMBOL	DESCRIPTION
C_R	Rated capacitance at 100 Hz, tolerance -10 % to +50 %
I_R	Rated RMS ripple current at 100 Hz, 85 °C
I_{L1}	Max. leakage current after 1 min at U_R
I_{L5}	Max. leakage current after 5 min at U_R
$\tan \delta$	Max. dissipation factor at 100 Hz
ESR	Equivalent series resistance at 100 Hz (calculated from $\tan \delta_{max}$ and C_R)
Z	Max. impedance at 10 kHz

ORDERING EXAMPLE

Electrolytic capacitor 041 series
 10 μ F / 250 V; -10 % / +50 %
 Nominal case size: \varnothing 10 mm x 25 mm; Form BA
 Ordering code: MAL204133109E3
 Former 12NC: 2222 041 33109

Note

- Unless otherwise specified, all electrical values in Table 3 apply at $T_{amb} = 20$ °C, P = 86 kPa to 106 kPa, RH = 45 % to 75 %.

ELECTRICAL DATA AND ORDERING INFORMATION														
U_R (V)	C_R 100 Hz (μ F)	NOMINAL CASE SIZE \varnothing D x L (mm)	CASE CODE	I_R 100 Hz 85 °C (mA)	I_{L1} 1 min (μ A)	I_{L5} 5 min (μ A)	$\tan \delta$ 100 Hz	ESR 100 Hz (Ω)	Z 10 kHz (Ω)	LIFE CODE ⁽¹⁾	ORDERING CODE MAL2.....			
											IN BOX FORM AA	TAPED ON REEL FORM BR	TAPED IN BOX FORM BA	MOUNTING RING FORM MR
160	10	8 x 18	5	70	68	14	0.15	24	12	L1	-	04121109E3	04131109E3	-
	22	10 x 25	7	150	130	25	0.15	11	5.5	L1	-	04121229E3	04131229E3	-
	22	10 x 30	00	190	42	25	0.10	6.8	5.5	L2	04211229E3	04221229E3	-	-
	33	12.5 x 30	01	270	58	36	0.10	4.5	3.1	L2	04211339E3	04221339E3	-	-
	47	15 x 30	02	350	78	49	0.10	3.2	2.1	L2	04211479E3	04221479E3	-	04241479E3
	68	15 x 30	02	420	110	69	0.10	2.2	1.4	L2	04211689E3	04221689E3	-	04241689E3
	100	18 x 30	03	580	150	100	0.10	1.5	1.0	L2	04211101E3	-	-	04241101E3
	150	18 x 38	04	760	230	150	0.10	1.0	0.7	L2	04311151E3	-	-	04341151E3
220	21 x 38	05	940	330	220	0.10	0.7	0.5	L2	04311221E3	-	-	04341221E3	
250	10	10 x 30	00	130	33	19	0.10	15	11	L2	04213109E3	04223109E3	-	-
	15	12.5 x 30	01	180	44	27	0.10	10	7.4	L2	04213159E3	04223159E3	-	-
	22	12.5 x 30	01	220	60	37	0.10	6.8	5.0	L2	04213229E3	04223229E3	-	-
	33	15 x 30	02	290	84	54	0.10	4.5	3.4	L2	04213339E3	04223339E3	-	04243339E3
	47	18 x 30	03	400	120	75	0.10	3.2	2.3	L2	04213479E3	-	-	04243479E3
	68	18 x 38	04	520	160	110	0.10	2.2	1.7	L2	04313689E3	-	-	04343689E3
	100	21 x 38	05	650	240	150	0.10	1.5	1.1	L2	04313101E3	-	-	04343101E3
350	6.8	10 x 30	00	110	32	18	0.10	22	14	L2	04215688E3	04225688E3	-	-
	10	12.5 x 30	01	150	42	25	0.10	15	10	L2	04215109E3	04225109E3	-	-
	15	12.5 x 30	01	180	57	36	0.10	10	6.7	L2	04215159E3	04225159E3	-	-
	22	15 x 30	02	250	79	50	0.10	6.8	4.5	L2	04215229E3	04225229E3	-	04245229E3
	33	18 x 30	03	350	110	73	0.10	4.5	3.1	L2	04215339E3	-	-	04245339E3
	47	18 x 38	04	450	160	100	0.10	3.2	2.1	L2	04315479E3	-	-	04345479E3
68	21 x 38	05	560	220	150	0.10	2.2	1.4	L2	04315689E3	-	-	04345689E3	
385	6.8	10 x 30	00	110	34	20	0.10	22	14	L2	04218688E3	04228688E3	-	-
	10	12.5 x 30	01	150	45	27	0.10	15	10	L2	04218109E3	04228109E3	-	-
	15	15 x 30	02	210	62	39	0.10	10	6.0	L2	04218159E3	04228159E3	-	04248159E3
	22	18 x 30	03	290	86	55	0.10	6.8	4.1	L2	04218229E3	-	-	04248229E3
	33	18 x 38	04	380	120	80	0.10	4.5	2.7	L2	04318339E3	-	-	04348339E3
	47	18 x 38	04	450	170	110	0.10	3.2	2.1	L2	04318479E3	-	-	04348479E3
68	21 x 38	05	570	250	160	0.10	2.2	1.4	L2	04318689E3	-	-	04348689E3	



ELECTRICAL DATA AND ORDERING INFORMATION														
U _R (V)	C _R 100 Hz (μF)	NOMINAL CASE SIZE Ø D x L (mm)	CASE CODE	I _R 100 Hz 85 °C (mA)	I _{L1} 1 min (μA)	I _{L5} 5 min (μA)	tan δ 100 Hz	ESR 100 Hz (Ω)	Z 10 kHz (Ω)	LIFE CODE ⁽¹⁾	ORDERING CODE MAL2.....			
											IN BOX FORM AA	TAPED ON REEL FORM BR	TAPED IN BOX FORM BA	MOUNTING RING FORM MR
400	6.8	10 x 30	00	110	220	110	0.055	11.5	7.3	L2	04216688E3	04226688E3	-	-
	10	12.5 x 30	01	150	240	110	0.055	7.5	4.6	L2	04216109E3	04226109E3	-	-
	15	15 x 30	02	210	250	110	0.055	5.0	3.1	L2	04216159E3	04226159E3	-	04246159E3
	22	18 x 30	03	290	280	120	0.055	3.5	2.1	L2	04216229E3	-	-	04246229E3
	33	18 x 38	04	380	320	130	0.055	2.3	1.4	L2	04316339E3	-	-	04346339E3
	47	18 x 38	04	450	370	140	0.055	1.7	1.1	L2	04316479E3	-	-	04346479E3
	68	21 x 38	05	560	440	150	0.055	1.2	0.7	L2	04316689E3	-	-	04346689E3
450	6.8	10 x 30	00	110	230	110	0.10	22	14	L3	04217688E3	04227688E3	-	-
	10	12.5 x 30	01	150	240	110	0.10	15	10	L3	04217109E3	04227109E3	-	-
	15	12.5 x 30	01	180	260	110	0.10	10	6.0	L3	04217159E3	04227159E3	-	-
	22	15 x 30	02	240	290	120	0.10	6.8	4.1	L3	04217229E3	04227229E3	-	04247229E3
	33	18 x 30	03	350	330	130	0.10	4.5	2.7	L3	04217339E3	-	-	04247339E3
	47	18 x 38	04	440	390	140	0.10	3.2	2.1	L3	04317479E3	-	-	04347479E3
	68	21 x 38	05	550	460	160	0.10	2.2	1.4	L3	04317689E3	-	-	04347689E3

Note

(1) Determines the applicable row in the table "Endurance Test Duration and Useful Life"

ADDITIONAL ELECTRICAL DATA			
PARAMETER	CONDITIONS	VALUE	
		AXIAL	MOUNTING RING
Voltage			
Surge voltage	U _R = 160 V to 250 V	U _s ≤ 1.15 x U _R	
	U _R = 350 V to 450 V	U _s ≤ 1.1 x U _R	
Reverse voltage		U _{rev} ≤ 1 V	
Current			
Leakage current	After 1 min: case Ø D x L = 8 mm x 18 mm to 10 mm x 25 mm: CV ≤ 1000 μC CV > 1000 μC case Ø D x L = 10 mm x 30 mm to 21 mm x 38 mm: U _R = 160 V to 385 V U _R = 400 V and 450 V	I _{L1} ≤ 0.05 C _R x U _R or 5 μA, whichever is greater I _{L1} ≤ 0.03 C _R x U _R + 20 μA I _{L1} ≤ 0.009 C _R x U _R + 10 μA I _{L1} ≤ 0.009 C _R x U _R + 200 μA	
	After 5 min: U _R = 160 V to 385 V: CV ≤ 1000 μC CV > 1000 μC U _R = 400 V and 450 V	I _{L5} ≤ 0.01 C _R x U _R or 1 μA, whichever is greater I _{L5} ≤ 0.006 C _R x U _R + 4 μA I _{L5} ≤ 0.002 C _R x U _R + 100 μA	
Inductance			
Equivalent series inductance (ESL)	Case Ø D x L mm:		
	8 x 18	Typ. 35 nH	-
	10 x 18	Typ. 69 nH	-
	10 x 25	Typ. 38 nH	-
	10 x 30	Typ. 38 nH	-
	12.5 x 30	Typ. 46 nH	-
	15 x 30	Typ. 48 nH	Typ. 39 nH
	18 x 30	Typ. 50 nH	Typ. 39 nH
	18 x 38	Typ. 54 nH	Typ. 39 nH
21 x 38	Typ. 59 nH	Typ. 39 nH	

CAPACITANCE (C)

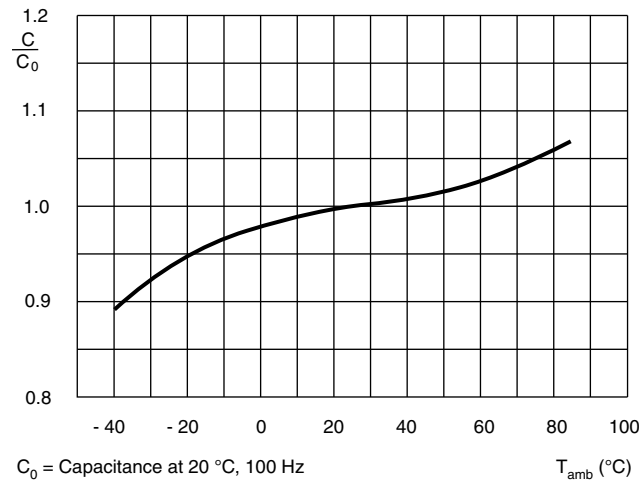

Fig. 5 - Typical multiplier of capacitance as a function of ambient temperature

EQUIVALENT SERIES RESISTANCE (ESR)

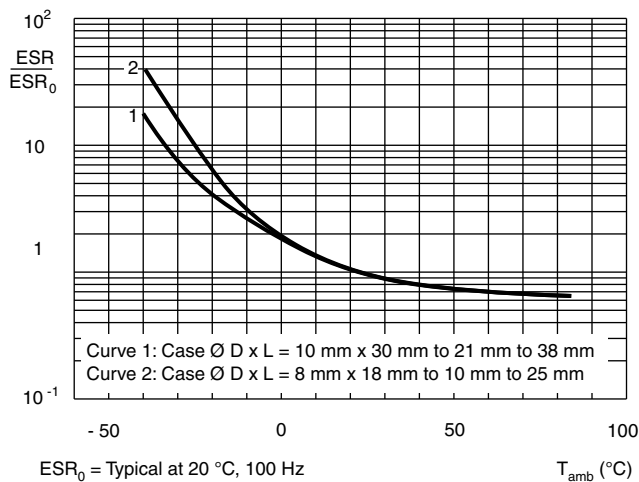

Fig. 6 - Typical multiplier of ESR as a function of ambient temperature

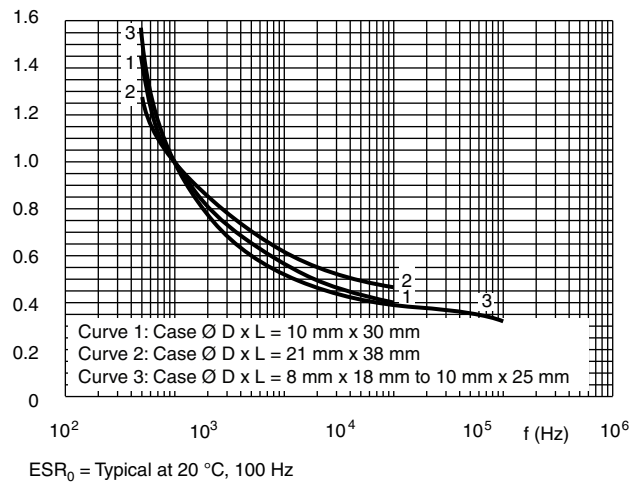

Fig. 7 - Typical multiplier of ESR as a function of frequency



IMPEDANCE (Z)

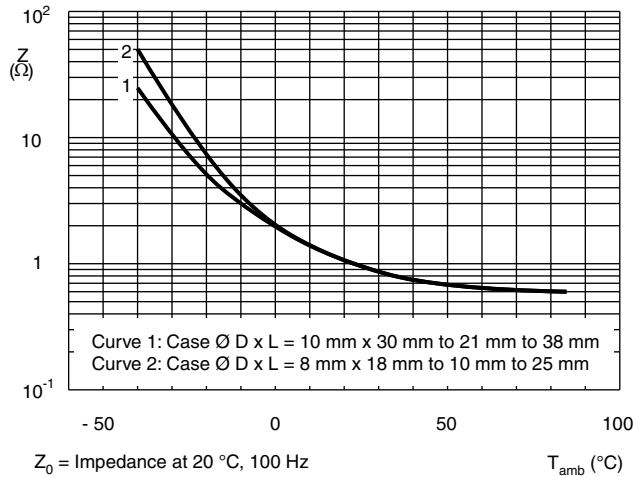

Fig. 8 - Typical impedance of capacitance as a function of ambient temperature

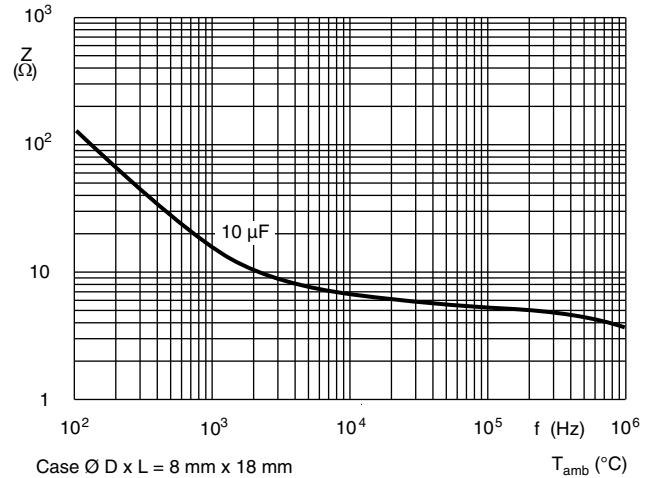

Fig. 9 - Typical impedance as a function of frequency

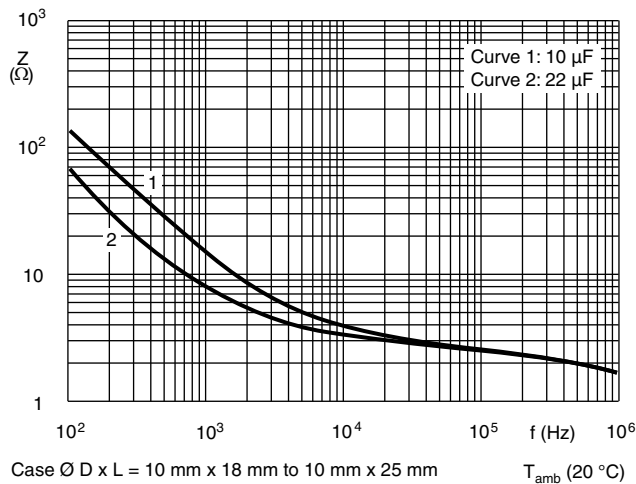

Fig. 10 - Typical impedance as a function of frequency

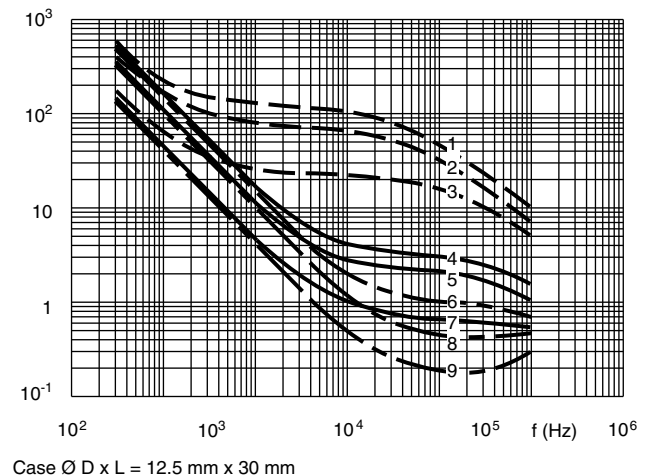

Fig. 11 - Typical impedance as a function of frequency at different ambient temperatures

- Curve 1: 10 µF, 350 V and 385 V; -40 °C
- Curve 2: 15 µF, 250 V; -40 °C
- Curve 3: 33 µF, 160 V; -40 °C
- Curve 4: 10 µF, 350 V and 385 V; 20 °C
- Curve 5: 15 µF, 250 V; 20 °C
- Curve 6: 33 µF, 160 V; 20 °C
- Curve 7: 10 µF, 350 V and 385 V; 85 °C
- Curve 8: 15 µF, 250 V; 85 °C
- Curve 9: 33 µF, 160 V; 85 °C



RIPPLE CURRENT AND USEFUL LIFE

Table 3

ENDURANCE TEST DURATION AND USEFUL LIFE		
LIFE CODE	ENDURANCE AT 85 °C (h)	USEFUL LIFE AT 85 °C (h)
L1	2000	5000
L2	8000	15 000
L3	5000	10 000

Note

- Multiplier of useful life code: CCC205

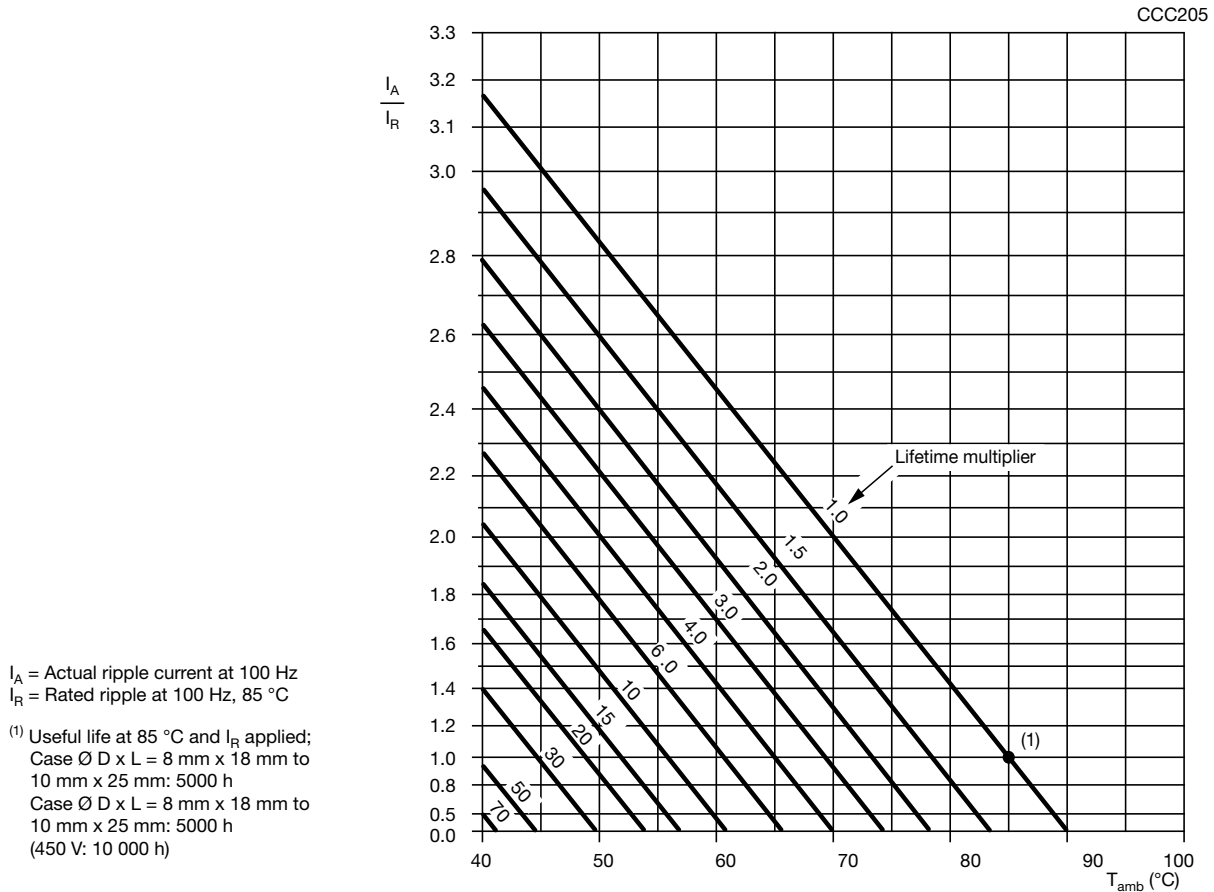

Fig. 12 - Multiplier of useful life as a function of ambient temperature and ripple current load

Table 4

MULTIPLIER OF RIPPLE CURRENT (I_R) AS A FUNCTION OF FREQUENCY					
FREQUENCY (Hz)					
50	100	300	1000	3000	≥ 10 000
I_R MULTIPLIER					
0.75	1.00	1.15	1.30	1.40	1.50



Table 5

TEST PROCEDURE REQUIREMENTS			
TEST		PROCEDURE (quick reference)	REQUIREMENTS
NAME OF TEST	REFERENCE		
Endurance	IEC 60384-4 / EN130300 subclause 4.13	T _{amb} = 85 °C; U _R applied; Case Ø D x L: 8 mm x 18 mm to 10 mm x 25 mm: 2000 h; 10 mm x 30 mm to 21 mm x 38 mm: 8000 h (450 V: 5000 h)	U _R = 160 V; ΔC/C: ± 15 % U _R = 250 V to 450 V; ΔC/C: ± 10 % tan δ ≤ 1.3 x spec. limit Z ≤ 2 x spec. limit I _{L5} ≤ spec. limit
Useful life	CECC 30301 subclause 1.8.1	T _{amb} = 85 °C; U _R and I _R applied; Case Ø D x L: 8 mm x 18 mm to 10 mm x 25 mm: 5000 h; 10 mm x 30 mm to 21 mm x 38 mm: 15 000 h (450 V: 10 000 h)	U _R = 160 V; ΔC/C: ± 45 % U _R = 250 V to 450 V; ΔC/C: ± 30 % tan δ ≤ 3 x spec. limit Z ≤ 3 x spec. limit I _{L5} ≤ spec. limit No short or open circuit Total failure percentage: ≤ 3 %
Shelf life (storage at high temperature)	IEC 60384-4 / EN130300 subclause 4.17	T _{amb} = 85 °C; no voltage applied; 500 h After test: U _R to be applied for 30 min, 24 h to 48 h before measurement	ΔC/C, tan δ, Z: for requirements see "Endurance test" above I _{L5} ≤ 2 x spec. limit

Statements about product lifetime are based on calculations and internal testing. They should only be interpreted as estimations. Also due to external factors, the lifetime in the field application may deviate from the calculated lifetime. In general, nothing stated herein shall be construed as a guarantee of durability.



Disclaimer

ALL PRODUCT, PRODUCT SPECIFICATIONS AND DATA ARE SUBJECT TO CHANGE WITHOUT NOTICE TO IMPROVE RELIABILITY, FUNCTION OR DESIGN OR OTHERWISE.

Vishay Intertechnology, Inc., its affiliates, agents, and employees, and all persons acting on its or their behalf (collectively, "Vishay"), disclaim any and all liability for any errors, inaccuracies or incompleteness contained in any datasheet or in any other disclosure relating to any product.

Vishay makes no warranty, representation or guarantee regarding the suitability of the products for any particular purpose or the continuing production of any product. To the maximum extent permitted by applicable law, Vishay disclaims (i) any and all liability arising out of the application or use of any product, (ii) any and all liability, including without limitation special, consequential or incidental damages, and (iii) any and all implied warranties, including warranties of fitness for particular purpose, non-infringement and merchantability.

Statements regarding the suitability of products for certain types of applications are based on Vishay's knowledge of typical requirements that are often placed on Vishay products in generic applications. Such statements are not binding statements about the suitability of products for a particular application. It is the customer's responsibility to validate that a particular product with the properties described in the product specification is suitable for use in a particular application. Parameters provided in datasheets and / or specifications may vary in different applications and performance may vary over time. All operating parameters, including typical parameters, must be validated for each customer application by the customer's technical experts. Product specifications do not expand or otherwise modify Vishay's terms and conditions of purchase, including but not limited to the warranty expressed therein.

Except as expressly indicated in writing, Vishay products are not designed for use in medical, life-saving, or life-sustaining applications or for any other application in which the failure of the Vishay product could result in personal injury or death. Customers using or selling Vishay products not expressly indicated for use in such applications do so at their own risk. Please contact authorized Vishay personnel to obtain written terms and conditions regarding products designed for such applications.

No license, express or implied, by estoppel or otherwise, to any intellectual property rights is granted by this document or by any conduct of Vishay. Product names and markings noted herein may be trademarks of their respective owners.