

## 3 Volt Voltage Variable Attenuator 25 dB, DC-2.5 GHz

V1

### Features

- Single Voltage Control: 0 to -3 Volts
- 25 dB Attenuation Range at 0.9 GHz
- Low DC Power Consumption
- Lead-Free SOT-25 Package
- 100% Matte Tin Plating over Copper
- Halogen-Free “Green” Mold Compound
- 260°C Reflow Compatible
- RoHS\* Compliant Version of AT-255

### Description

M/A-COM’s MAAVSS0006 is a GaAs MMIC voltage variable absorptive attenuator in a lead-free SOT-25 surface mount plastic package. The MAAVSS0005 is ideally suited for use where variable attenuation, fine tuning, and very low power consumption are required.

Typical applications include radio, cellular, GPS equipment and automatic gain/level control circuits.

The MAAVSS0006 is fabricated using a mature 1-micron GaAs MESFET process. The process features full chip passivation for increased performance and reliability.

### Ordering Information

Part Number	Package
MAAVSS0006	Bulk Packaging
MAAVSS0006TR-3000	3000 piece reel
MAAVSS0006SMB	Sample Board

1. Reference Application Note M513 for reel size information.
2. All sample boards include 5 loose parts.

### Functional Schematic <sup>1</sup>

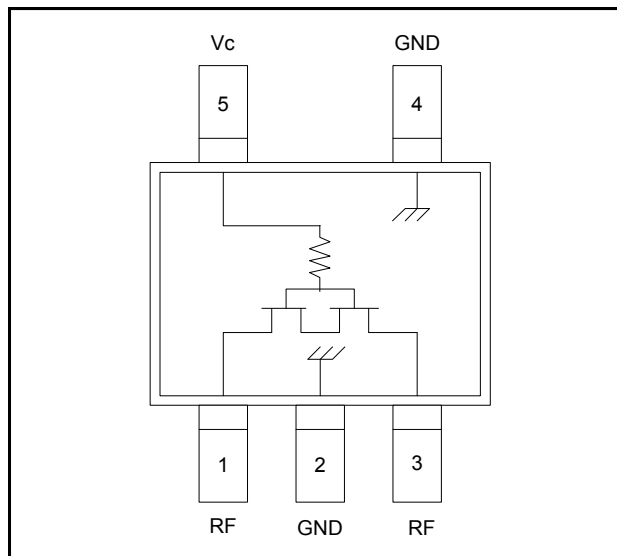

3.  $V_C = -3\text{ V to }0\text{ V @ }25\text{ }\mu\text{A maximum.}$

### Pin Configuration

Pin No.	Function	Pin No.	Function
1	RF Port	4	Ground
2	Ground	5	$V_C$
3	RF Port		

### Absolute Maximum Ratings <sup>2,3</sup>

Parameter	Absolute Maximum
Input Power	+21 dBm
Control Voltage $V_C$	$-8\text{ V} \leq V_C \leq +0.5\text{ V}$
Operating Temperature	$-40^\circ\text{C to }+85^\circ\text{C}$
Storage Temperature	$-65^\circ\text{C to }+150^\circ\text{C}$

4. Exceeding any one or combination of these limits may cause permanent damage to this device.
5. MA-COM does not recommend sustained operation near these survivability limits.

\* Restrictions on Hazardous Substances, European Directive 2002/95/EC.

## 3 Volt Voltage Variable Attenuator 25 dB, DC-2.5 GHz

V1

Electrical Specifications:  $T_A = 25^\circ\text{C}$ ,  $Z_0 = 50 \Omega$

Parameter	Test Conditions	Units	Min	Typ	Max
Insertion Loss <sup>5</sup>	DC - 2.0 GHz	dB	—	3.6	4.2
Attenuation	DC - 1.0 GHz	dB	23	25	—
	1.0 - 2.0 GHz	dB	18	20	—
Flatness (Peak-to-Peak)	0.5 - 1.0 GHz	dB	—	$\pm 7$	$\pm 10$
	1.0 - 2.0 GHz	dB	—	$\pm 5$	$\pm 8$
VSWR	DC - 2.0 GHz	Ratio	—	3:1	—
Trise, Tfall	10% to 90% RF, 90% to 10% RF	nS	—	10	—
Ton, Toff	50% Control to 90% RF, 50% Control to 10% RF	nS	—	20	—
Transients	In Band	mV	—	10	—

5. Insertion loss varies 0.003 dB/°C.

### Lead-Free SOT-25<sup>†</sup>

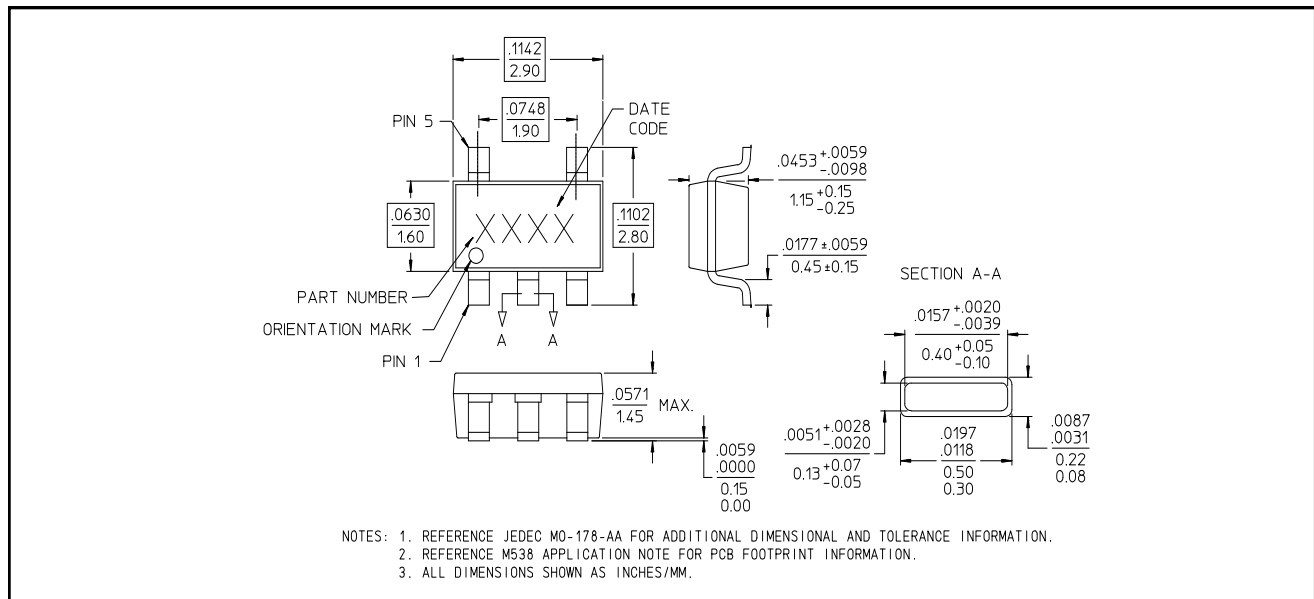

<sup>†</sup> Reference Application Note M538 for lead-free solder reflow recommenda-

Meets JEDED moisture Sensitivity Level 1 requirements

### Handling Procedures

Please observe the following precautions to avoid damage:

### Static Sensitivity

Gallium Arsenide Integrated Circuits are sensitive to electrostatic discharge (ESD) and can be damaged by static electricity. Proper ESD control techniques should be used when handling these devices.

## 3 Volt Voltage Variable Attenuator 25 dB, DC-2.5 GHz

V1

### Typical Performance Curves

Relative Attenuation vs. Control Voltage

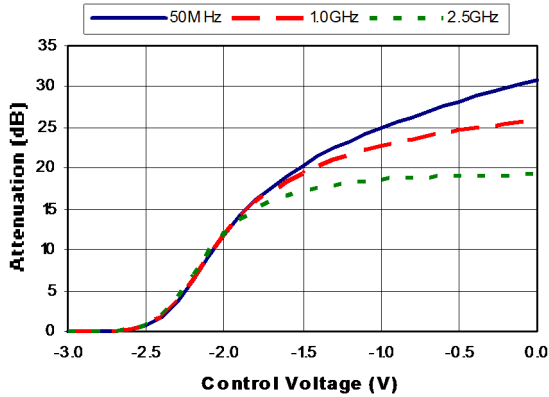

Insertion Loss vs. Frequency

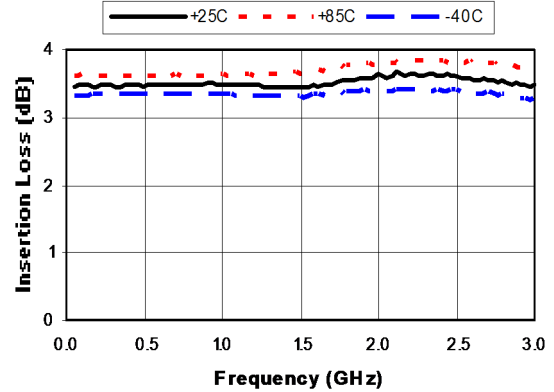

Maximum Relative Attenuation vs. Frequency

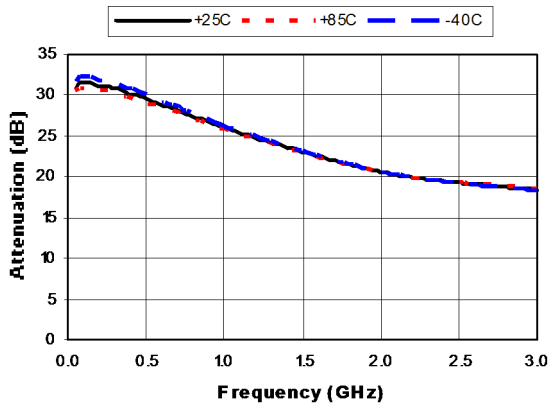

Return Loss vs. Control Voltage @ 900 MHz

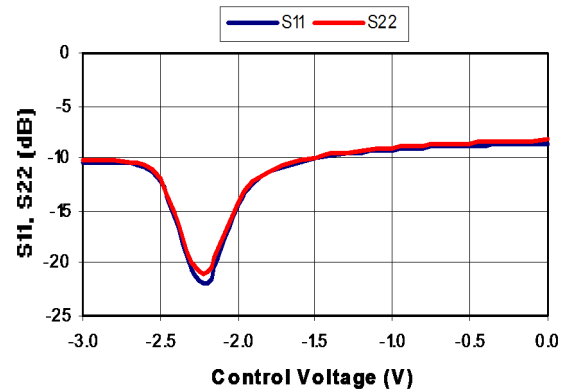

Input IP3 vs. Control Voltage

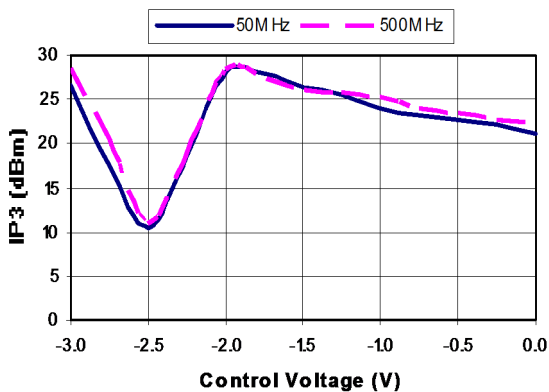

Input P1dB vs. Control Voltage

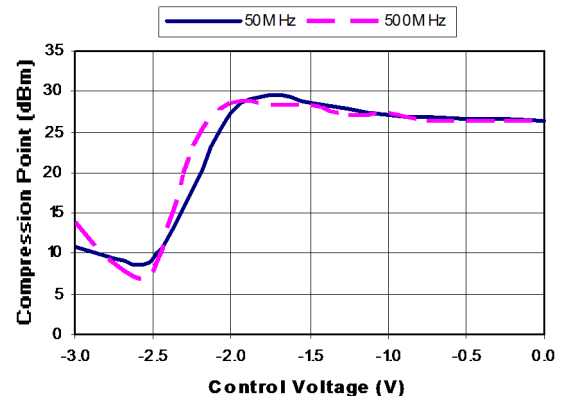

M/A-COM Technology Solutions Inc. All rights reserved.

Information in this document is provided in connection with M/A-COM Technology Solutions Inc ("MACOM") products. These materials are provided by MACOM as a service to its customers and may be used for informational purposes only. Except as provided in MACOM's Terms and Conditions of Sale for such products or in any separate agreement related to this document, MACOM assumes no liability whatsoever. MACOM assumes no responsibility for errors or omissions in these materials. MACOM may make changes to specifications and product descriptions at any time, without notice. MACOM makes no commitment to update the information and shall have no responsibility whatsoever for conflicts or incompatibilities arising from future changes to its specifications and product descriptions. No license, express or implied, by estoppel or otherwise, to any intellectual property rights is granted by this document.

THESE MATERIALS ARE PROVIDED "AS IS" WITHOUT WARRANTY OF ANY KIND, EITHER EXPRESS OR IMPLIED, RELATING TO SALE AND/OR USE OF MACOM PRODUCTS INCLUDING LIABILITY OR WARRANTIES RELATING TO FITNESS FOR A PARTICULAR PURPOSE, CONSEQUENTIAL OR INCIDENTAL DAMAGES, MERCHANTABILITY, OR INFRINGEMENT OF ANY PATENT, COPYRIGHT OR OTHER INTELLECTUAL PROPERTY RIGHT. MACOM FURTHER DOES NOT WARRANT THE ACCURACY OR COMPLETENESS OF THE INFORMATION, TEXT, GRAPHICS OR OTHER ITEMS CONTAINED WITHIN THESE MATERIALS. MACOM SHALL NOT BE LIABLE FOR ANY SPECIAL, INDIRECT, INCIDENTAL, OR CONSEQUENTIAL DAMAGES, INCLUDING WITHOUT LIMITATION, LOST REVENUES OR LOST PROFITS, WHICH MAY RESULT FROM THE USE OF THESE MATERIALS.

MACOM products are not intended for use in medical, lifesaving or life sustaining applications. MACOM customers using or selling MACOM products for use in such applications do so at their own risk and agree to fully indemnify MACOM for any damages resulting from such improper use or sale.