

Ultra small Broadband General Purpose Amplifier 4 - 20 GHz

Rev. V3

Features

- Gain: 16 dB
- Flatness: ± 2 dB
- 50 Ω match in and out
- P1dB: +18 dBm @ 14 GHz
- Single DC supply, +5 V to +12 V, 45 mA
- Lead-Free 1.5 x 1.2 mm 6-Lead TDFN package
- Halogen-Free “Green” Mold Compound
- RoHS* Compliant and 260°C Reflow Compatible

Description

The MAAM-011101 operates from 4 to 20 GHz and features 16 dB typical gain and +18 dBm of output power. The input and output are fully matched to 50 Ω with a typical return loss better than 12 dB. Small signal linearity is typically +30 dBm and reverse isolation better than 28 dB. This device requires a minimum of +5V, typically +8V, and maximum +10V for standard operation. Typical current is 45 mA.

Typical usage is a system buffer amplifier, gain block, mixer LO driver, power amplifier driver requiring small size and high performance. Typical applications are for WiFi, WiMAX, Point-to-Point radios, IMS, EW, and Aerospace and Defense.

The MAAM-011101 is housed in a leadless 1.5 x 1.2 mm package that is small yet can be handled and placed with standard pick and place assembly equipment. It is fabricated using a GaAs process which features full passivation for increased performance and reliability.

Functional Schematic

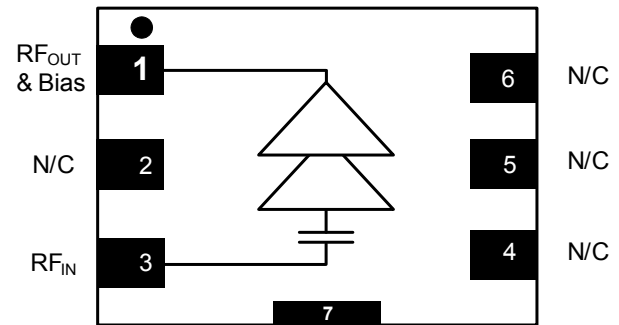

Pin Configuration

Pin No.	Pin Name	Description
1	RF _{OUT}	RF Output & Bias (Vd)
2	N/C	No Connection
3	RF _{IN}	RF Input
4	N/C	No Connection
5	N/C	No Connection
6	N/C	No Connection
7 ³	Paddle	GND

3. The exposed pad centered on the package bottom must be connected to RF and DC ground.

Ordering Information^{1,2}

Part Number	Package
MAAM-011101-TR1000	1000 Piece Reel
MAAM-011101-001SMB	Sample Test Board

1. Reference Application Note M513 for reel size information.
2. All sample boards include 5 loose parts.

*Restrictions on Hazardous Substances,
European Union Directive 2011/65/EU.

Ultra small Broadband General Purpose Amplifier 4 - 20 GHz

Rev. V3

Electrical Specifications: $T_A = +25^\circ\text{C}$, $V_D = +8$ Volts, $Z_0 = 50 \Omega$

Parameter	Test Conditions	Units	Min.	Typ.	Max.
Gain	4 GHz	dB	—	13	—
	8 GHz		17	19	
	12 GHz		—	16	
	16 GHz		—	15	
	20 GHz		—	15	
Noise Figure	4 - 20 GHz	dB	—	4	—
Input Return Loss	6 - 18 GHz	dB	—	12	—
Output Return Loss	6 - 18 GHz	dB	—	14	—
Isolation	4 - 20 GHz	dB	—	30	—
P1dB	4 GHz	dBm	—	+15	—
	8 GHz		+16	+17	
	12 GHz		—	+19	
	16 GHz		—	+19	
	20 GHz		—	+18	
I_{DD}	+8 Volts	mA	35	45	55

Absolute Maximum Ratings^{4,5,6}

Parameter	Absolute Maximum
RF Input Power	+23 dBm
Voltage	+12 volts
Operating Temperature	-40°C to +85°C
Junction Temperature ⁷	+150°C
Storage Temperature	-65°C to +150°C

- Exceeding any one or combination of these limits may cause permanent damage to this device.
- MACOM does not recommend sustained operation near these survivability limits.
- Operating at nominal conditions with $T_J \leq +150^\circ\text{C}$ will ensure $MTTF > 1 \times 10^6$ hours.
- Junction Temperature (T_J) = $T_C + \Theta_{JC} * ((V * I) - (P_{OUT} - P_{IN}))$
Typical thermal resistance (Θ_{JC}) = 40°C/W
 - For $T_C = 25^\circ\text{C}$,
 $T_J = +43^\circ\text{C}$ @ +10 V, 45 mA, $P_{OUT} = -4$ dBm, $P_{IN} = -20$ dBm
 - For $T_C = 85^\circ\text{C}$,
 $T_J = +103^\circ\text{C}$ @ +10 V, 45 mA, $P_{OUT} = -3$ dBm, $P_{IN} = -20$ dBm

Handling Procedures

Please observe the following precautions to avoid damage:

Static Sensitivity

Gallium Arsenide Integrated Circuits are sensitive to electrostatic discharge (ESD) and can be damaged by static electricity. Proper ESD control techniques should be used when handling these Class 1A devices.

Recommended PCB

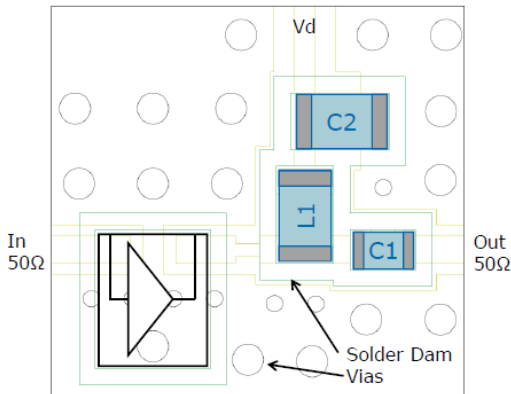

Application Schematic

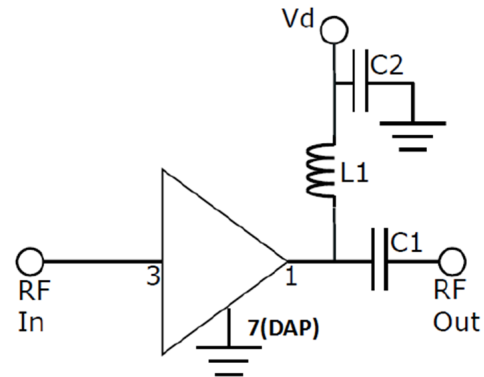

Parts List

Comp.	Value	Pkg.	Manf.	Purpose
C1	100 pF	0201	Murata GRM0335C1E101	DC Block
C2	100 pF	0402	Murata GRM1555C1E101	Bypass
L1	470 Ω	0402	Murata BLM15GG471	Choke

Evaluation Board

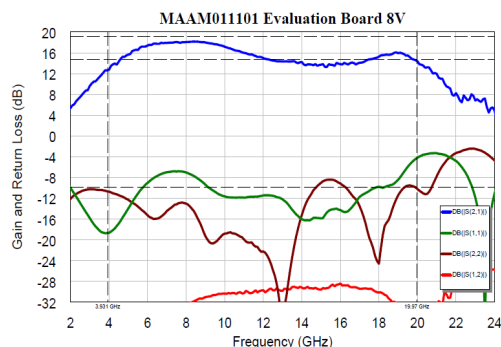
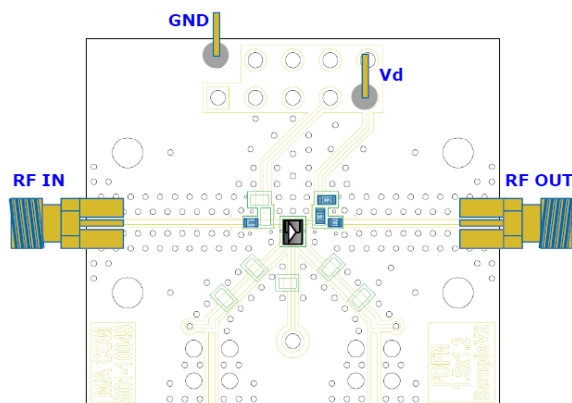

Application Information

The MAAM-011101 is designed to be easy to use yet high performance. The ultra small size, no matching, and simple bias allows easy placement on any system board.

LO Buffer applications:

The MAAM-011101 is good as a LO buffer since it has excellent isolation, selectable power output, low phase noise, and 50 Ω match (even under heavy drive). It is designed to deliver saturated output levels up to +20 dBm common to driving mixer configurations. It is typically used in conjunction with filters or splitters after the VCO or PLL.

PA Driver applications:

The MAAM-011101 makes a very good low cost driver before the transmit power amplifier. Set typically 7 dB backed off P1dB as a linear driver, it still delivers up to +12 dBm. Often cascaded in series with an attenuator, it allows gain control with little pulling due to mis-match. The low gain expansion allows little AM-to-AM distortion.

Grounding:

It is recommended that the total ground (common mode) inductance not exceed 0.03 nH (30 pH). This is equivalent to at least four 8 mil (200 u) vias per 8 mil board (200 u) be place under the device to ground

DC Bias Tee:

To bias properly, a DC voltage must be applied at the output pin. Typically this is down with a 2 element bias network that consists of a choke and a DC blocking capacitor. We recommend a high Q inductor for the choke and quality capacitor for the DC block.

Ultra small Broadband General Purpose Amplifier 4 - 20 GHz

Rev. V3

Typical Performance Curves over temperature, $V_D = +8\text{ V}$, $Z_0 = 50\ \Omega$

Gain

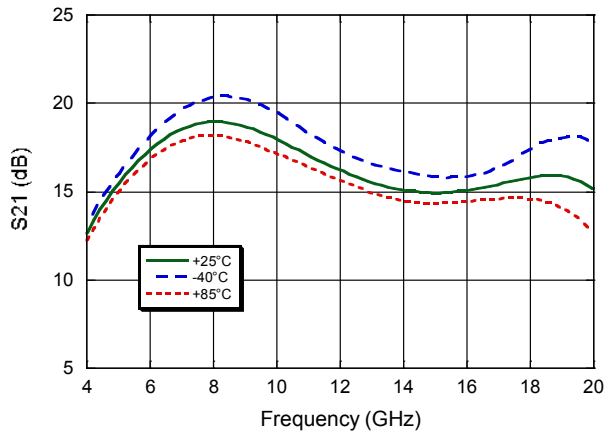

Noise Figure

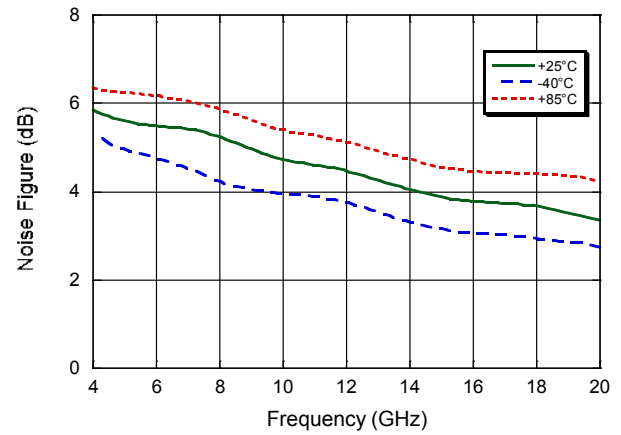

Input Return Loss

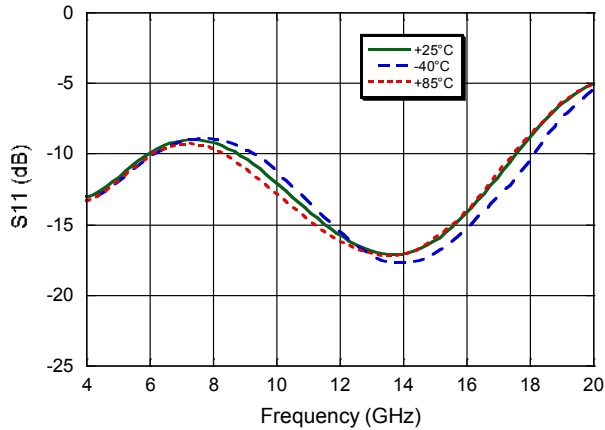

Output Return Loss

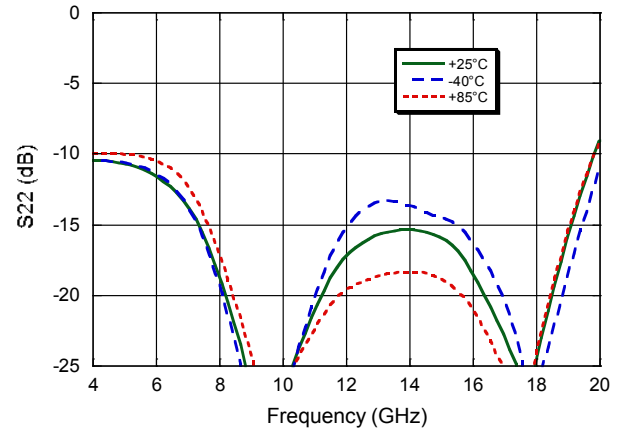

Output P1dB

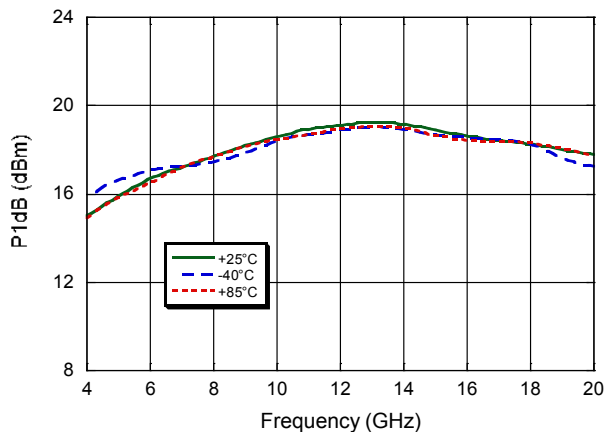

Output IP3

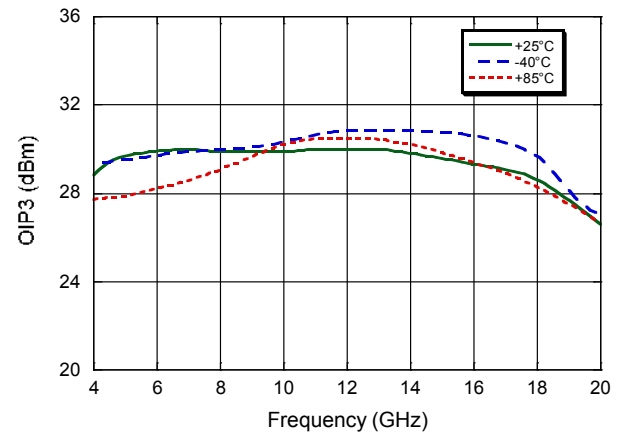

Ultra small Broadband General Purpose Amplifier 4 - 20 GHz

Rev. V3

Typical Performance Curves over supply voltage, $T_A = +25^\circ\text{C}$, $Z_0 = 50 \Omega$

Gain

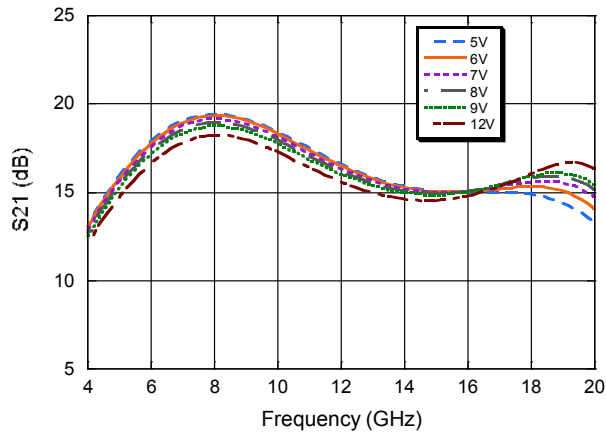

Noise Figure

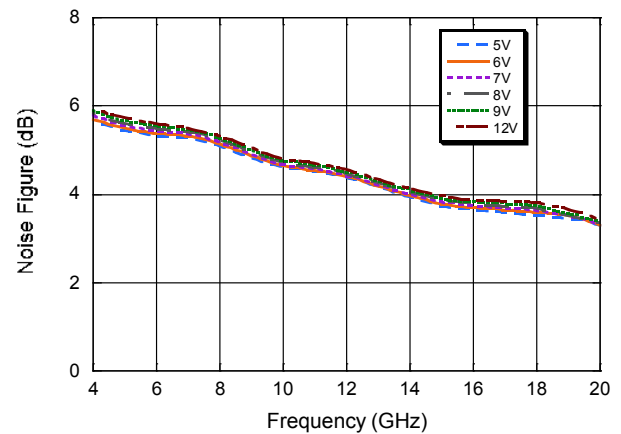

Input Return Loss

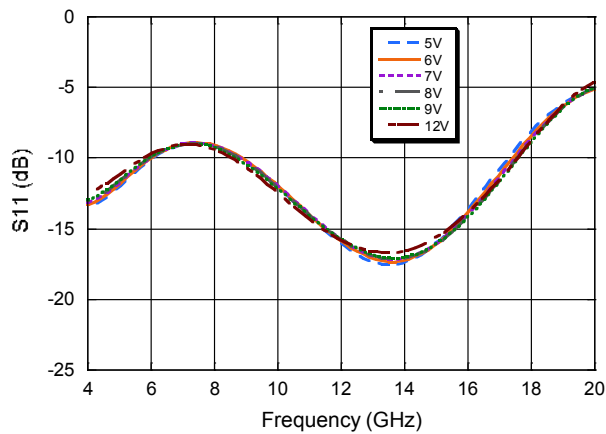

Output Return Loss

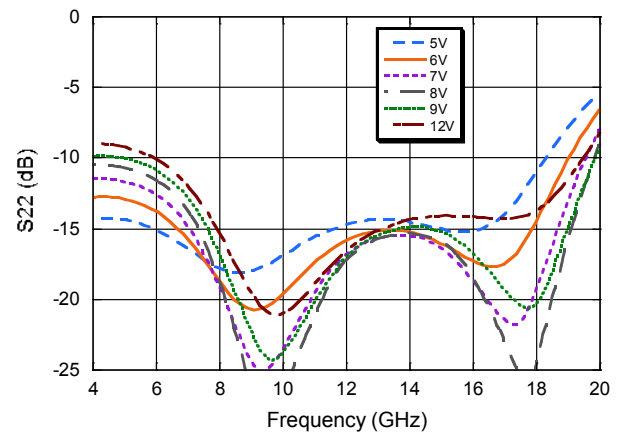

Output P1dB

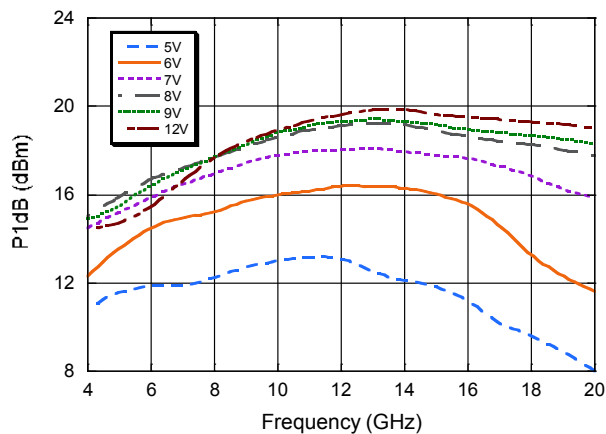

Output IP3

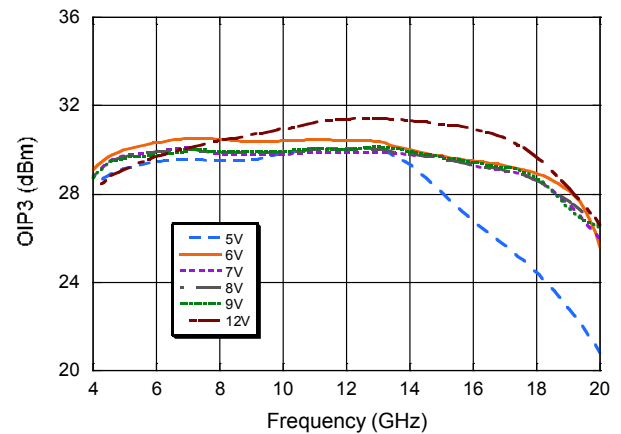

Typical Performance Curves

Isolation over voltage

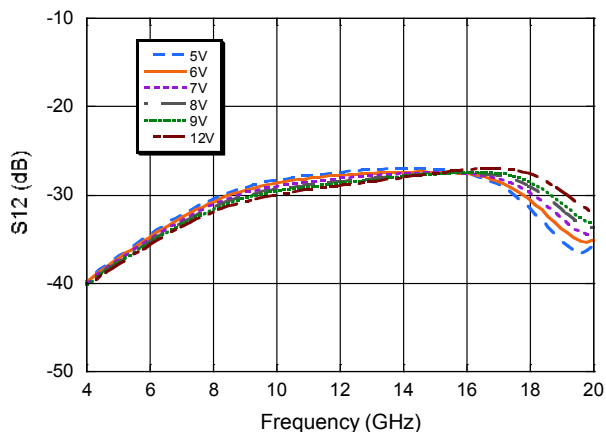

Isolation over temperature

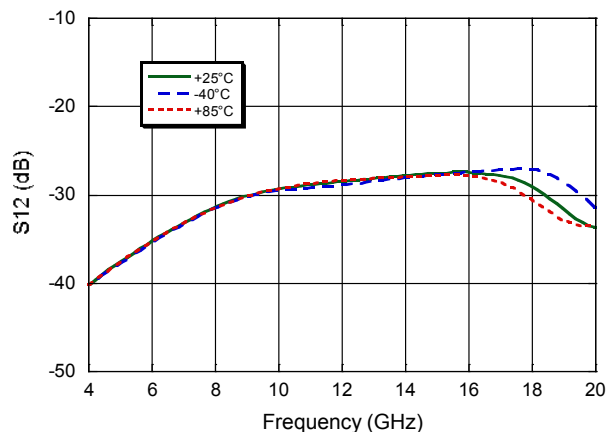

Current vs. Voltage over temperature

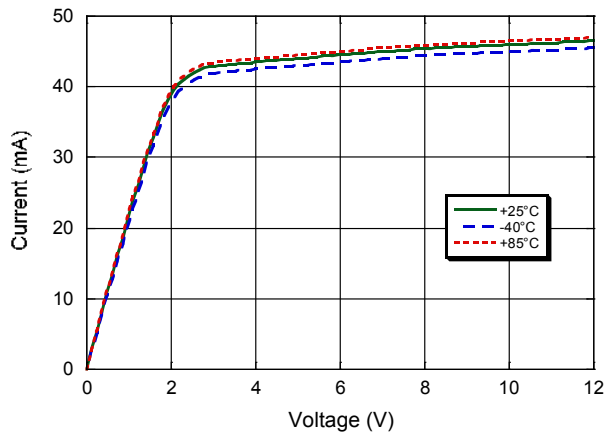

Gain vs. Voltage over temperature @ 12 GHz

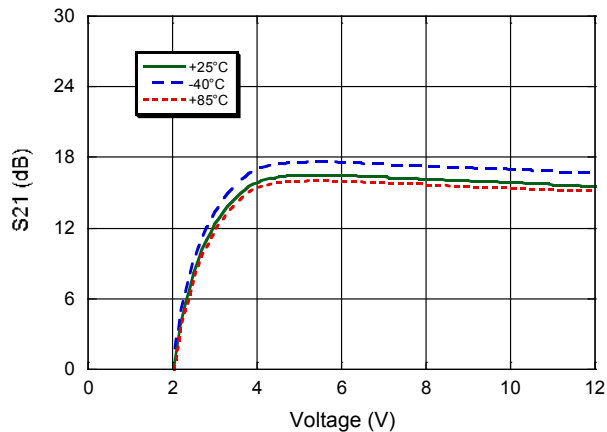

Output P1dB @ 12 GHz

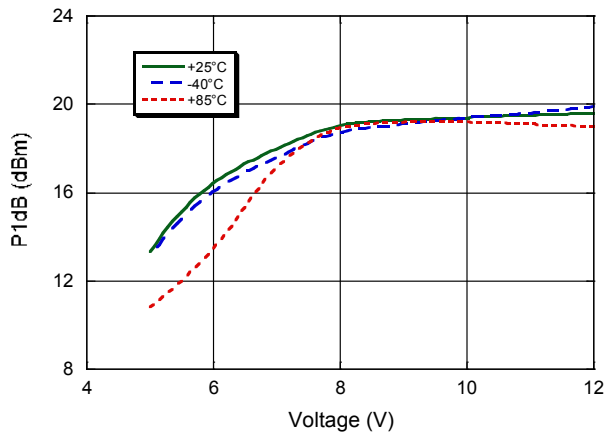

Output IP3 @ 12 GHz

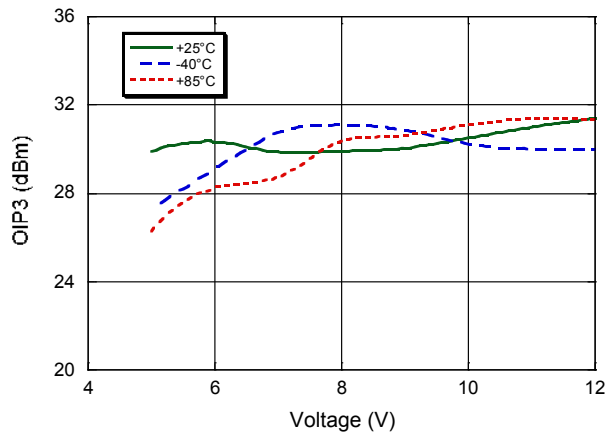

Lead-Free 1.5 x 1.2 mm 6-Lead TDFN[†]

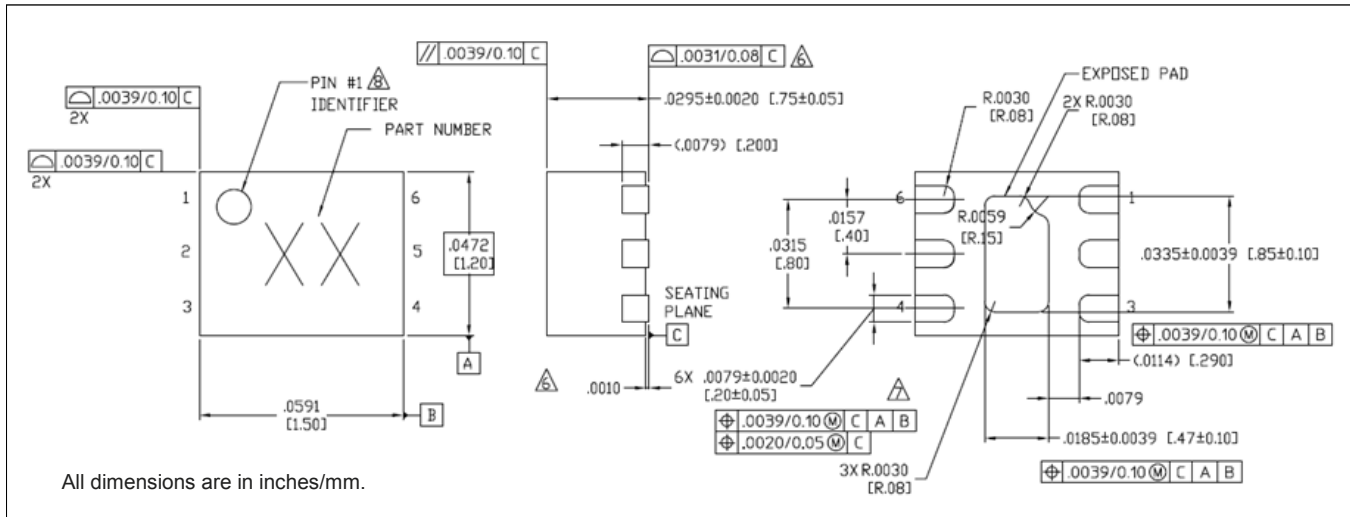

[†] Reference Application Note S2083 for lead-free solder reflow recommendations.
Meets JEDEC moisture sensitivity level 1 requirements.
Plating is 100% matte tin over copper.

M/A-COM Technology Solutions Inc. All rights reserved.

Information in this document is provided in connection with M/A-COM Technology Solutions Inc ("MACOM") products. These materials are provided by MACOM as a service to its customers and may be used for informational purposes only. Except as provided in MACOM's Terms and Conditions of Sale for such products or in any separate agreement related to this document, MACOM assumes no liability whatsoever. MACOM assumes no responsibility for errors or omissions in these materials. MACOM may make changes to specifications and product descriptions at any time, without notice. MACOM makes no commitment to update the information and shall have no responsibility whatsoever for conflicts or incompatibilities arising from future changes to its specifications and product descriptions. No license, express or implied, by estoppel or otherwise, to any intellectual property rights is granted by this document.

THESE MATERIALS ARE PROVIDED "AS IS" WITHOUT WARRANTY OF ANY KIND, EITHER EXPRESS OR IMPLIED, RELATING TO SALE AND/OR USE OF MACOM PRODUCTS INCLUDING LIABILITY OR WARRANTIES RELATING TO FITNESS FOR A PARTICULAR PURPOSE, CONSEQUENTIAL OR INCIDENTAL DAMAGES, MERCHANTABILITY, OR INFRINGEMENT OF ANY PATENT, COPYRIGHT OR OTHER INTELLECTUAL PROPERTY RIGHT. MACOM FURTHER DOES NOT WARRANT THE ACCURACY OR COMPLETENESS OF THE INFORMATION, TEXT, GRAPHICS OR OTHER ITEMS CONTAINED WITHIN THESE MATERIALS. MACOM SHALL NOT BE LIABLE FOR ANY SPECIAL, INDIRECT, INCIDENTAL, OR CONSEQUENTIAL DAMAGES, INCLUDING WITHOUT LIMITATION, LOST REVENUES OR LOST PROFITS, WHICH MAY RESULT FROM THE USE OF THESE MATERIALS.

MACOM products are not intended for use in medical, lifesaving or life sustaining applications. MACOM customers using or selling MACOM products for use in such applications do so at their own risk and agree to fully indemnify MACOM for any damages resulting from such improper use or sale.