

D6F-□N2/-02L2

MEMS Flow Sensor

A Compact, High-accuracy Sensor That Measures Low Flow Rates.

- High accuracy of $\pm 3\%$ FS.
- Flow rates can be measured without being affected by temperature or pressure.

RoHS Compliant



Refer to the *Safety Precautions* on page 3.

Ordering Information

Model	Applicable fluid	Flow rate range	Minimum order
D6F-01N2-000	City gas (13A)	0 to 1 L/min	1
D6F-02N2-000		0 to 2 L/min.	1
D6F-05N2-000		0 to 5 L/min	1
D6F-02L2-000	Propane gas	0 to 2 L/min.	1

Connections

D6F-01N2-000

D6F-02N2-000

D6F-05N2-000

D6F-02L2-000

Pin No. 1: Vcc
2: Vout
3: GND

Connector 53398 (Made by Molex Japan)

Use the following connectors for connections to the D6F:

Housing 51021 (Made by Molex Japan)
Terminals 50079 (Made by Molex Japan)
Wires AWG28 to AWG26

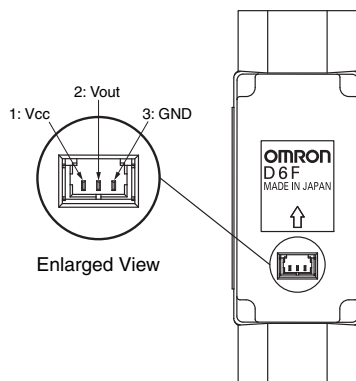

Output Voltage Characteristics

D6F-01N2-000

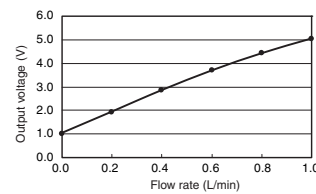

D6F-05N2-000

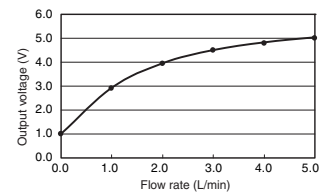

D6F-02N2-000

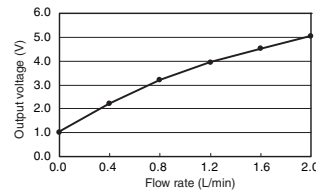

D6F-02L2-000

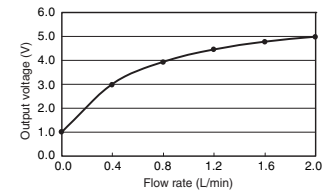

D6F-01N2-000

Flow rate L/min (normal)	0	0.2	0.4	0.6	0.8	1.0
Output voltage V	1.00 ± 0.12	1.90 ± 0.12	2.81 ± 0.12	3.64 ± 0.12	4.37 ± 0.12	5.00 ± 0.12

D6F-02N2-000

Flow rate L/min (normal)	0	0.4	0.8	1.2	1.6	2.0
Output voltage V	1.00 ± 0.12	2.19 ± 0.12	3.18 ± 0.12	3.96 ± 0.12	4.55 ± 0.12	5.00 ± 0.12

D6F-05N2-000

Flow rate L/min (normal)	0	1.0	2.0	3.0	4.0	5.0
Output voltage V	1.00 ± 0.12	2.91 ± 0.12	3.92 ± 0.12	4.47 ± 0.12	4.79 ± 0.12	5.00 ± 0.12

D6F-02L2-000

Flow rate L/min (normal)	0	0.4	0.8	1.2	1.6	2.0
Output voltage V	1.00 ± 0.30	3.02 ± 0.08	3.95 ± 0.08	4.47 ± 0.08	4.79 ± 0.08	5.00 ± 0.12

Measurement conditions: Power supply voltage of 12 ± 0.1 VDC, ambient temperature of $25 \pm 5^\circ\text{C}$, and ambient humidity of 35% to 75%.

D6F-□N2/-02L2

Characteristics/Performance

Model	D6F-01N2-000	D6F-02N2-000	D6F-05N2-000	D6F-02L2-000
Flow Range (See note 1.)	0 to 1 L/min	0 to 2 L/min.	0 to 5 L/min	0 to 2 L/min.
Calibration Gas (See note 2.)	City gas (13A)			Propane gas
Flow Port Type	Rc 1/4 thread			
Electrical Connection	Three-pin connector			
Power Supply	10.8 to 26.4 VDC			
Current Consumption	15 mA max. with no load, with a Vcc of 12 to 24 VDC, and at 25°C			
Output Voltage	1 to 5 VDC (non-linear output, load resistance of 10 kΩ)			
Accuracy	±3% FS (25°C characteristic)			±2% to ±7.5% F.S. (25°C characteristic)
Repeatability (See note 3.)	±0.2% FS			±0.3% FS
Output Voltage (Max.)	5.7 VDC (Load resistance: 10 kΩ)			
Output Voltage (Min.)	0 VDC (Load resistance: 10 kΩ)			
Rated Power Supply Voltage	26.4 VDC			
Rated Output Voltage	6 VDC			
Case	Aluminum alloy			
Degree of Protection	IEC IP40			
Withstand Pressure	200 kPa			
Pressure Drop (See note 3.)	0.017 kPa	0.033 kPa	0.10 kPa	0.14 kPa
Operating Temperature	-10 to 60°C (with no condensation or icing)			
Operating Humidity	35% to 85% (with no condensation or icing)			
Storage Temperature	-40 to 80°C (with no condensation or icing)			
Storage Humidity	35% to 85% (with no condensation or icing)			
Temperature Characteristics	±3% FS for 25°C characteristic at -10 to 60°C			±4% FS for 25°C characteristic at -10 to 60°C
Insulation Resistance	Between Sensor outer cover and lead terminals: 20 MΩ min. (at 500 VDC)			
Dielectric Strength	Between Sensor outer cover and lead terminals: 500 VAC, 50/60 Hz min. for 1 min (leakage current: 1 mA max.)			
Weight	35.3 g			

Note: 1. A 0 to 1 L/min. (normal) volumetric flow rate at 0°C, 101.3 kPa.

Note: 2. Dry gas. (must not contain large particles, e.g., dust, oil, or mist.)

Note: 3. Reference (typical)

Dimensions (Unit: mm)

D6F-01N2-000
D6F-02N2-000
D6F-05N2-000
D6F-02L2-000

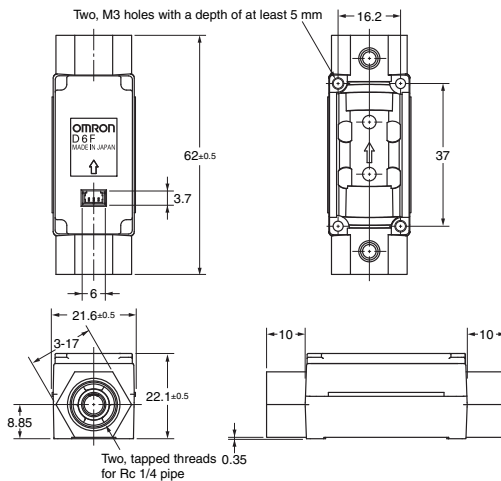
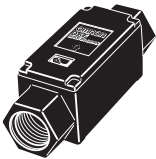

Mounting Hole Dimensions

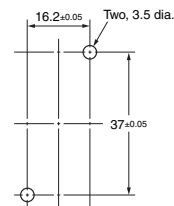

Lead Wire (included): D6F-CABLE1

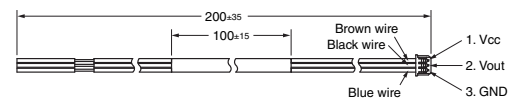

Safety Precautions

⚠ WARNING

The D6F is built for use with general-purpose devices. In cases such as those described below, where safety is required, implementation measures to ensure the safety of the system and all devices, such as fail-safe designs, redundancy designs, and regular maintenance.

- Safety devices for ensuring safety for persons
- Transportation equipment control (such as applications to stop operation)
- Aviation and space equipment
- Nuclear power equipment

Do not use the D6F for applications in which D6F operation would directly affect human life.

⚠ Caution

Make sure that the power to all equipment is turned OFF before you install the Sensor. Installing the Sensor while the power supply is ON may result in electrical shock or abnormal operation.

Precautions for Correct Use

● Fluids, Pipes, and Sensor Installation

All Models

- (1) Use clean fluids. Dust and mist can affect the characteristics of the Sensor or damage the Sensor. Install a filter and mist separator on the upstream pipe. (Not required for the D6F-W□A1, D6F-V, D6F-P or D6F-PH.)
- (2) Do not use combustible gases (e.g., hydrogen), corrosive gases (e.g., chlorine, sulfur, acidic, or alkali gas), or other non-approved fluids. They may damage the Sensor.
- (3) The performance specifications that are given for the G6F do not apply if any fluids other than the specified applicable fluid are used.
- (4) Foreign matter in the pipes that are connected to the Sensor may damage the Sensor. Prevent any foreign matter from entering the pipes after the Sensor is removed from its packaging.
- (5) Attach the pipes so that fluid flows only in the direction designated by the arrows on the Sensor. Correct measurements cannot be obtained if the fluid flows in the wrong direction.
- (6) We recommend that you install the pipes horizontally. If the pipes are not installed horizontally, an error of $\pm 1\%$ FS or higher may result. (This does not apply to the D6F-03A3.)
- (7) Install the Sensor on a flat surface. Incorrect installation may damage the Sensor and make it impossible to obtain correct measurements.
- (8) After the Sensor is installed, check to confirm that it operates correctly.
- (9) Do not drop the Sensor, remove the cover, or attempt to disassemble the Sensor in any way.

D6F-01N2, D6F-02N2, D6F-05N2, and D6F-02L2

- (1) Use the Rc 1/4 tapped threads for the pipes, and tighten the threads to a maximum torque of 5 N·m. Tightening beyond this value may result in fractures, which can cause leaks.

- (2) Use M3 panhead screws to install the Sensor, and tighten them to a maximum torque of 0.59 N·m.

● Operating Environment

Do not use the Sensor in the following locations:

- Locations directly subject to heat radiated from heating equipment
- Locations subject to water or oil
- Locations subject to direct sunlight
- Locations subject to intense temperature changes
- Locations subject to icing or condensation
- Locations subject to excessive vibration or shock

● Countermeasures against Noise

Noise may make it impossible to obtain correct measurements. Consider the following countermeasures.

- Allow as much space as possible between the Sensor and devices that generates high frequencies (such as high-frequency welders and high-frequency sewing machines) or surges.
- Attach surge absorbers or noise filters to noise-generating devices that are near the Sensor (in particular, equipment with inductance, such as motors, transformers, solenoids, and magnetic coils).
(It also helps to separate pipes and ducts, and to use shielded cables.)

● Power Supply

- Do not directly solder power supply leads to the connector terminals. Use only the appropriate connectors.
- Wire with the correct terminal names and polarities. Incorrect wiring will cause failure of internal components.
- When using a commercially available switching regulator, ground the FG (frame ground) and G (ground) terminals.

RoHS Directive

The RoHS mark is displayed on the packing of products for which the six substances banned by the RoHS Directive have been abolished (both in processing and in the electronic components mounted to the PCBs).

* RoHS marking may be terminated if it is later determined that parts that were previously treated as RoHS compliant are not compliant due to circumstances at the supplier of the parts.

● RoHS Compliance Criteria

The following standards are used to determine RoHS compliance for the six banned substances.

(Items to which the RoHS Directive is not applicable are not given.)

- Lead: 1,000 ppm max.
- Hexavalent chromium: 1,000 ppm max.
- Mercury: 1,000 ppm max.
- PBB: 1,000 ppm max.
- Cadmium: 100 ppm max.
- PBDE: 1,000 ppm max.

• Application examples provided in this document are for reference only. In actual applications, confirm equipment functions and safety before using the product.
• Consult your OMRON representative before using the product under conditions which are not described in the manual or applying the product to nuclear control systems, railroad systems, aviation systems, vehicles, combustion systems, medical equipment, amusement machines, safety equipment, and other systems or equipment that may have a serious influence on lives and property if used improperly. Make sure that the ratings and performance characteristics of the product provide a margin of safety for the system or equipment, and be sure to provide the system or equipment with double safety mechanisms.

Note: Do not use this document to operate the Unit.

OMRON Corporation
Electronic and Mechanical Components Company

Contact: www.omron.com/ecb

Cat. No. A180-E1-04
1015(0109)(O)