



# KERN CPB

Version 1.2 2/2007

## Operating Manual Counting balance

### Contents

<b>1</b>	<b>Technical data</b>	<b>39</b>
<b>2</b>	<b>Declaration of conformity</b>	<b>41</b>
<b>3</b>	<b>Device overview</b>	<b>43</b>
<b>3.1</b>	<b>Overview of display</b>	<b>44</b>
3.1.1	Display weight	44
3.1.2	Display reference weight	44
3.1.3	Display quantity	44
<b>3.2</b>	<b>Keyboard overview</b>	<b>45</b>
<b>4</b>	<b>Basic Information (General)</b>	<b>46</b>
<b>4.1</b>	<b>Proper use</b>	<b>46</b>
<b>4.2</b>	<b>Improper Use</b>	<b>46</b>
<b>4.3</b>	<b>Warranty</b>	<b>46</b>
<b>4.4</b>	<b>Monitoring of Test Resources</b>	<b>47</b>
<b>5</b>	<b>Basic Safety Precautions</b>	<b>47</b>
<b>5.1</b>	<b>Pay attention to the instructions in the Operation Manual</b>	<b>47</b>
<b>5.2</b>	<b>Personnel training</b>	<b>47</b>
<b>6</b>	<b>Transport and storage</b>	<b>47</b>
<b>6.1</b>	<b>Testing upon acceptance</b>	<b>47</b>
<b>6.2</b>	<b>Packaging</b>	<b>47</b>
<b>7</b>	<b>Unpacking, Setup and Commissioning</b>	<b>48</b>
<b>7.1</b>	<b>Installation Site, Location of Use</b>	<b>48</b>
<b>7.2</b>	<b>Unpacking</b>	<b>48</b>
7.2.1	Setup	48
7.2.2	Scope of delivery	49
<b>7.3</b>	<b>Mains connection</b>	<b>49</b>
<b>7.4</b>	<b>Battery power supply</b>	<b>49</b>
<b>7.5</b>	<b>Connection of peripheral devices</b>	<b>49</b>
<b>7.6</b>	<b>Initial Commissioning</b>	<b>49</b>
<b>7.7</b>	<b>Adjustment with external weight</b>	<b>50</b>
7.7.1	Models CPB (Non verifiable models)	50
7.7.2	Models CPB.. M (verifiable models)	51
<b>7.8</b>	<b>Verification</b>	<b>53</b>
7.8.1	Jumper and seals	54

<b>8</b>	<b><i>Weighing</i></b>	<b>55</b>
8.1	Switch on/off and set zero	55
8.2	Simple weighing	55
8.3	Weighing with taring	56
8.3.1	Determination of the tare weight by weighing	56
<b>9</b>	<b><i>Parts counting</i></b>	<b>57</b>
9.1	Determination of the reference weight by weighing	57
9.2	Numeric entering of the reference weight	59
9.3	Automatic reference optimization	59
9.4	Target piece input	60
9.5	Manual total memory	60
9.6	Automatic total memory	61
<b>10</b>	<b><i>Data Interface RS 232C</i></b>	<b>62</b>
10.1	Technical data	62
10.2	Pin allocation for the balance output socket (front view)	62
10.3	Data format	62
10.4	Interface parameter	64
10.5	Input commands format	65
10.6	Setting the date/time	66
<b>11</b>	<b><i>Display background illumination</i></b>	<b>67</b>
<b>12</b>	<b><i>AUTO OFF function</i></b>	<b>68</b>
<b>13</b>	<b><i>Service, maintenance, disposal</i></b>	<b>69</b>
13.1	Cleaning	69
13.2	Service, maintenance	69
13.3	Disposal	69
<b>14</b>	<b><i>Instant help</i></b>	<b>70</b>

## 1 Technical data

<b>KERN</b>	<b>CPB 3K0.1</b>	<b>CPB 6K0.2</b>	<b>CPB 15K0.5</b>	<b>CPB 30 K1</b>
<i>Readability (d)</i>	0,1 g	0,2 g	0,5 g	1 g
<i>Weighing range (max)</i>	3 kg	6 kg	15 kg	30 kg
<i>Reproducibility</i>	0,1 g	0,2 g	0,5 g	1 g
<i>Linearity</i>	± 0,4 g	± 0,8 g	± 1,5 g	± 3 g
<i>Stabilization time</i>	2 sec.	2 sec.	2 sec.	2 sec.
<i>Recommended adjusting weight (not supplied)</i>	3 kg (M1)	5 kg (M1)	10 kg (M1)	20 kg (M1)
<i>Minimum piece weight</i>	0,05 g	0,1 g	0,25 g	0,5 g
<i>Reference quantity</i>	<i>freely selectable</i>			
<i>Net weight (kg)</i>	4.1 kg			
<i>Permissible ambient condition</i>	-10° C to 40° C			
<i>Humidity of air</i>	15 % - 85 % (not condensing)			
<i>Weighing plate, stainless steel</i>	225 x 275 mm			
<i>Dimensions of the housing (B x D x H)</i>	315 x 355 x 110 mm			
<i>Mains connection</i>	<i>Mains adaptor 230 V, 50/60 Hz ; 9 V DC balance, 800 mA</i>			
<i>Battery</i>	<i>Operating time ca. 70 hrs. / Charging time ca. 12 hrs.</i>			

<b>KERN</b>	<b>CPB 3K1M</b>	<b>CPB 6K2M</b>	<b>CPB 15K5M</b>	<b>CPB 30K10M</b>
<i>Readability (d)</i>	1 g	2 g	5 g	10 g
<i>Weighing range (max)</i>	3 kg	6 kg	15 kg	30 kg
<i>Verification value e</i>	1 g	2 g	5 g	10 g
<i>Class of accuracy</i>	III	III	III	III
<i>Reproducibility</i>	1 g	2 g	5 g	10 g
<i>Linearity</i>	± 1 g	± 2 g	± 5 g	± 10 g
<i>Stabilization time</i>	2 sec.	2 sec.	2 sec.	2 sec.
<i>Recommended adjusting weight (not supplied)</i>	2 kg + 1 kg (F2)	5 kg (F2)	10 kg + 2 kg (F2)	20 kg + 5 kg (F2)
<i>Minimum piece weight</i>	0,05 g	0,1 g	0,25 g	0,5 g
<i>Reference quantity</i>	freely selectable			
<i>Net weight (kg)</i>	4.1 kg			
<i>Permissible ambient condition</i>	-10° C to 40° C			
<i>Humidity of air</i>	15 % - 85 % (not condensing)			
<i>Weighing plate, stainless steel</i>	225 x 275 mm			
<i>Dimensions of the housing (B x D x H)</i>	315 x 355 x 110 mm			
<i>Mains connection</i>	Mains adaptor 230 V, 50/60 Hz ; 9 V DC balance, 800 mA			
<i>Battery</i>	Operating time ca. 70 hrs. / Charging time ca. 12 hrs.			

## 2 Declaration of conformity



**KERN & Sohn GmbH**

D-72322 Balingen-Frommern

Postfach 4052

E-Mail: [info@kern-sohn.de](mailto:info@kern-sohn.de)

Tel: 0049-[0]7433- 9933-0

Fax: 0049-[0]7433-9933-149

Internet: [www.kern-sohn.de](http://www.kern-sohn.de)

### Konformitätserklärungen

**Declaration of conformity for apparatus with CE mark**

**Konformitätserklärung für Geräte mit CE-Zeichen**

**Déclaration de conformité pour appareils portant la marque CE**

**Declaración de conformidad para aparatos con marca CE**

**Dichiarazione di conformità per apparecchi contrassegnati con la marcatura CE**

- English** We hereby declare that the product to which this declaration refers conforms with the following standards.
- Deutsch** Wir erklären hiermit, daß das Produkt, auf das sich diese Erklärung bezieht, mit den nachstehenden Normen übereinstimmt.
- Français** Nous déclarons avec cela responsabilité que le produit, auquel se rapporte la présente déclaration, est conforme aux normes citées ci-après.
- Español** Manifestamos en la presente que el producto al que se refiere esta declaración está de acuerdo con las normas siguientes
- Italiano** Dichiariamo con ciò che il prodotto al quale la presente dichiarazione si riferisce è conforme alle norme di seguito citate.

### Electronic Scale: KERN CPB

Mark applied	EU Directive	Standards
CE	89/336/EEC EMC	EN 61326
	73/23/EEC Low Voltage	EN 60950-1 EN 61010

10.01.2007

Signature:

Gottl. KERN & Sohn GmbH  
Management

Gottl. KERN & Sohn GmbH, Ziegelei 1, D-72336 Balingen, Tel. +49-[0]7433/9933-0, Fax +49-[0]7433/9933-149



**KERN & Sohn GmbH**

D-72322 Balingen-Frommern

Postfach 4052

E-Mail: [info@kern-sohn.de](mailto:info@kern-sohn.de)

Tel: 0049-[0]7433- 9933-0

Fax: 0049-[0]7433-9933-149

Internet: [www.kern-sohn.de](http://www.kern-sohn.de)

## Konformitätserklärungen

**Declaration of conformity for apparatus with CE mark**

**Konformitätserklärung für Geräte mit CE-Zeichen**

**Déclaration de conformité pour appareils portant la marque CE**

**Declaración de conformidad para aparatos con marca CE**

**Dichiarazione di conformità per apparecchi contrassegnati con la marcatura CE**

- English** We hereby declare that the product to which this declaration refers conforms with the following standards.  
**This declaration is only valid with the certificate of conformity by a notified body.**
- Deutsch** Wir erklären hiermit, dass das Produkt, auf das sich diese Erklärung bezieht, mit den nachstehenden Normen übereinstimmt.  
**Diese Erklärung gilt nur in Verbindung mit der Konformitätsbescheinigung einer benannten Stelle.**
- Français** Nous déclarons avec cela responsabilité que le produit, auquel se rapporte la présente déclaration, est conforme aux normes citées ci-après.  
**Cette déclaration est valide seulement avec un certificat de conformité d'un organisme notifié.**
- Español** Manifestamos en la presente que el producto al que se refiere esta declaración está de acuerdo con las normas siguientes.  
**Esta declaración solo será válida acompañada del certificado de conformidad de conformidad de la parte nominal.**
- Italiano** Dichiariamo con ciò che il prodotto al quale la presente dichiarazione si riferisce è conforme alle norme di seguito citate.  
**Questa dichiarazione sarà valida solo se accompagnata dal certificato di conformità della parte nominale.**

## Electronic Scale: KERN CPB...M

EU Directive	Standards	EC-type-approval certificate no.	Issued by
90/384/EEC	EN 45501	TC 7102 / T7104	NMI

Date: 10.01.2007

Signature: 

Gottl. KERN & Sohn GmbH  
Management

Gottl. KERN & Sohn GmbH, Ziegelei 1, D-72336 Balingen, Tel. +49-07433/9933-0, Fax +49-074433/9933-149

### 3 Device overview

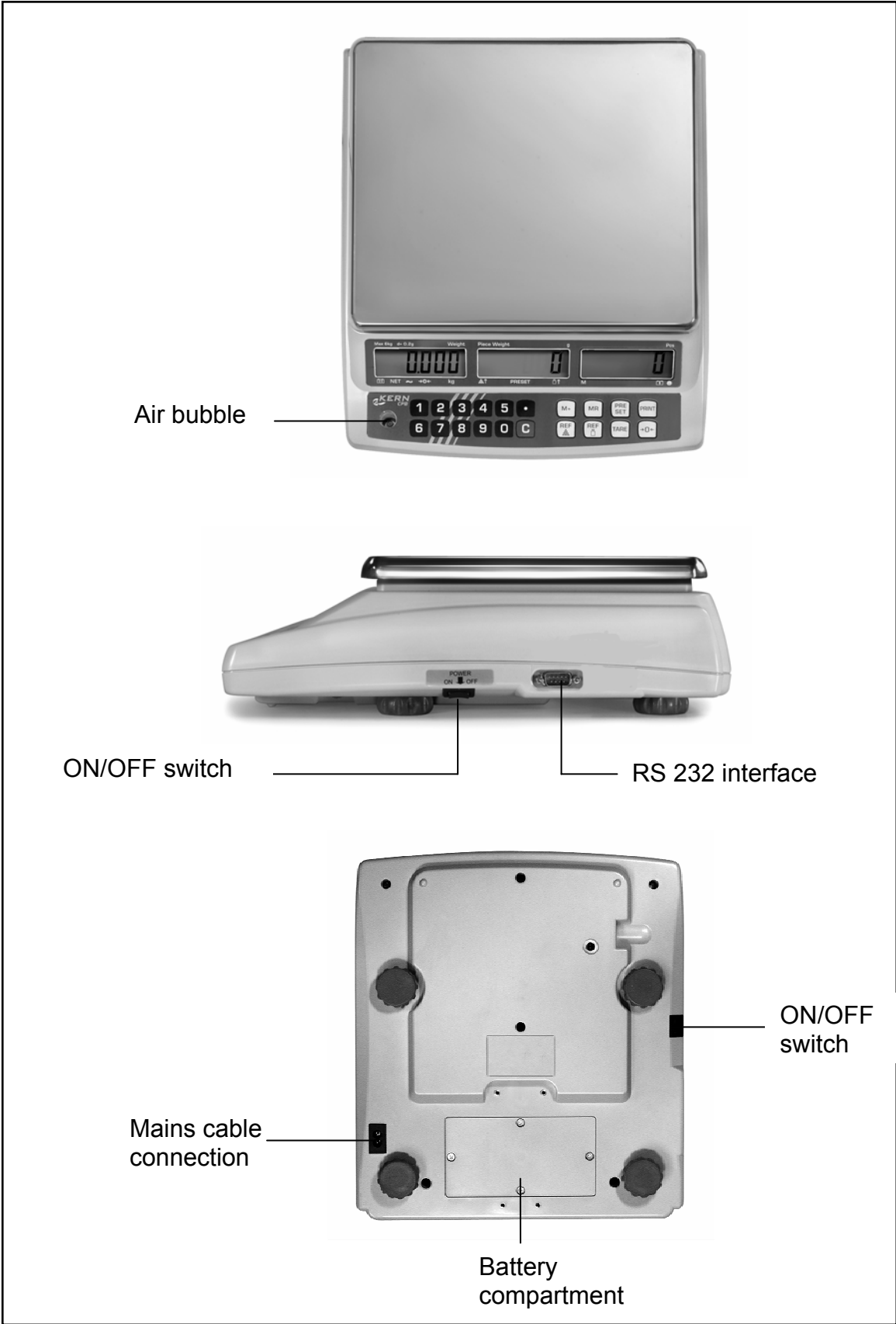

### 3.1 Overview of display

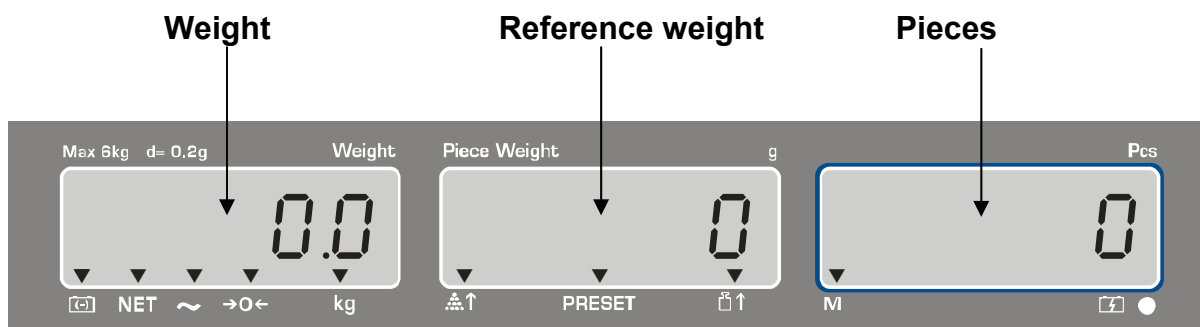

#### 3.1.1 Display weight

Here, the weight of your goods is displayed in [kg].

The arrows above the symbols show:

	Battery very low
<b>NET</b>	Net weight
	Stability display
<b>→0←</b>	Zeroing display

#### 3.1.2 Display reference weight

Here, the reference weight of a sample is displayed in [g]. This value is either entered by user or calculated by balance.

The arrows above the symbols show:

	Number of parts placed on balance too small
<b>PRESET</b>	Saved limit value
	Reference weight placed on balance too small

#### 3.1.3 Display quantity

Here, all the parts placed on balance are immediately displayed by number.











The arrows above the symbols show:

<b>M</b>	Data in memory
----------	----------------



### 3.2 Keyboard overview



Choice	Function
	<ul style="list-style-type: none"> <li>Number keys</li> </ul>
	<ul style="list-style-type: none"> <li>Delete key</li> </ul>
	<ul style="list-style-type: none"> <li>Addition in total memory</li> </ul>
	<ul style="list-style-type: none"> <li>Call up total memory</li> </ul>
	<ul style="list-style-type: none"> <li>Enter/display limit value for tolerance check</li> <li>Call up menu "Display background illumination"</li> </ul>
	<ul style="list-style-type: none"> <li>Output to external device (printer) or PC</li> </ul>
	<ul style="list-style-type: none"> <li>Enter reference weight through weighing</li> </ul>
	<ul style="list-style-type: none"> <li>Numeric entry reference weight</li> <li>Function /parameter selection</li> </ul>
	<ul style="list-style-type: none"> <li>Taring key</li> <li>Save</li> </ul>
	<ul style="list-style-type: none"> <li>Zeroing key</li> <li>Back to weighing mode</li> </ul>

## **4 Basic Information (General)**

### **4.1 Proper use**

The balance you purchased is intended to determine the weighing value of material to be weighed. It is intended to be used as a “non-automatic” balance, i.e. the material to be weighed is manually and carefully placed in the centre of the weighing plate. As soon as a stable weighing value is reached the weighing value can be read.

### **4.2 Improper Use**

Do not use balance for dynamic weighings. In the event that small quantities are removed or added to the material to be weighed, incorrect weighing results can be displayed due to the “stability compensation” in the balance. (Example: Slowly draining fluids from a container on the balance.)

Do not leave permanent load on the weighing plate. This may damage the measuring system.

Impacts and overloading exceeding the stated maximum load (max) of the balance, minus a possibly existing tare load, must be strictly avoided. Balance may be damaged by this.

Never operate balance in explosive environment. The serial version is not explosion protected.

The structure of the balance may not be modified. This may lead to incorrect weighing results, safety-related faults and destruction of the balance.

The balance may only be used according to the described conditions. Other areas of use must be released by KERN in writing.

### **4.3 Warranty**

Warranty claims shall be voided in case

- Our conditions in the operation manual are ignored
- The appliance is used outside the described uses
- The appliance is modified or opened
- mechanical damage or damage by media, liquids, natural wear and tear
- The appliance is improperly set up or incorrectly electrically connected
- The measuring system is overloaded

#### **4.4 Monitoring of Test Resources**

In the framework of quality assurance the measuring-related properties of the balance and, if applicable, the testing weight, must be checked regularly. The responsible user must define a suitable interval as well as type and scope of this test. Information is available on KERN's home page ([www.kern-sohn.com](http://www.kern-sohn.com)) with regard to the monitoring of balance test substances and the test weights required for this. In KERN's accredited DKD calibration laboratory test weights and balances may be calibrated (return to the national standard) fast and at moderate cost.

### **5 Basic Safety Precautions**

#### **5.1 Pay attention to the instructions in the Operation Manual**

Carefully read this operation manual before setup and commissioning, even if you are already familiar with KERN balances.

#### **5.2 Personnel training**

The appliance may only be operated and maintained by trained personnel.

### **6 Transport and storage**

#### **6.1 Testing upon acceptance**

When receiving the appliance, please check packaging immediately, and the appliance itself when unpacking for possible visible damage.

#### **6.2 Packaging**

Keep all parts of the original packaging in case you need to return the appliance.

Only use original packaging for returning.

Before sending, disconnect all connected cables and loose/movable parts.

Attach possibly existing transport safeguards. Secure all parts, e.g. weighing plate, power unit etc., to prevent slipping and damage.

## 7 Unpacking, Setup and Commissioning

### 7.1 Installation Site, Location of Use

The balances are designed in a way that reliable weighing results are achieved in common conditions of use.

You will work accurately and fast, if you select the right location for your balance.

***Therefore, observe the following for the installation site:***

- Place the balance on a firm, level surface;
- Avoid extreme heat as well as temperature fluctuation caused by installing next to a radiator or in the direct sunlight;
- Protect the balance against direct draughts due to open windows and doors;
- Avoid jarring during weighing;
- Protect the balance against high humidity, vapours and dust;
- Do not expose the device to extreme dampness for longer periods of time. Non-permitted condensation (condensation of air humidity on the appliance) may occur if a cold appliance is taken to a considerably warmer environment. In this case, acclimatize the disconnected appliance for ca. 2 hours at room temperature.
- Avoid static charge of goods to be weighed or weighing container.

If electro-magnetic fields or static charge occur, or if the power supply is unstable major deviations on the display (incorrect weighing results) are possible. In that case, the location must be changed.

### 7.2 Unpacking

Carefully remove the balance from the packaging, remove plastic cover and setup balance at the intended workstation.

#### 7.2.1 Setup

Level balance with foot screws until the air bubble of the water balance is in the prescribed circle.

## 7.2.2 Scope of delivery

### **Serial accessories:**

- Balance
- Weighing plate
- Power cable
- Protective cover
- Internal battery
- Operating Manual

## 7.3 Mains connection

Power is supplied via the external mains power supply. The stated voltage value must be the same as the local voltage. Only use original KERN mains power supplies. Using other makes requires consent by KERN.

## 7.4 Battery power supply

**The optionally supplied battery is charged with the supplied power supply.**

Before the first use, the battery should be charged by connecting it to the mains power supply for at least 15 hours. The operating time of the battery is about 70h. Charging time until complete recharging ca. 12h.

Selectable AUTO-OFF function after 1, 5, or 10 min (see chapt. 12).

If an arrow shows in the weight display [▼] above the battery symbol  or “bat lo” the capacity of the battery will soon be exhausted. The balance will be ready to operate for about another 10 min, then it will switch off automatically. Connect the power supply as soon as possible to change the battery.

The LED display below the parts counting window informs you about the charge status of the battery.

red: Battery is almost discharged

green: Battery is completely discharged

yellow: Battery should be charged over a longer period (over night)

## 7.5 Connection of peripheral devices

Before connecting or disconnecting of additional devices (printer, PC) to the data interface, always disconnect the balance from the power supply.

With your balance, only use accessories and peripheral devices by KERN, as they are ideally tuned to your balance.

## 7.6 Initial Commissioning

A warming up time of 2 h after switching on stabilizes the measuring values.

The accuracy of the balance depends on the local acceleration of gravity.

Strictly observe hints in chapter Adjustment.





## 7.7 Adjustment with external weight



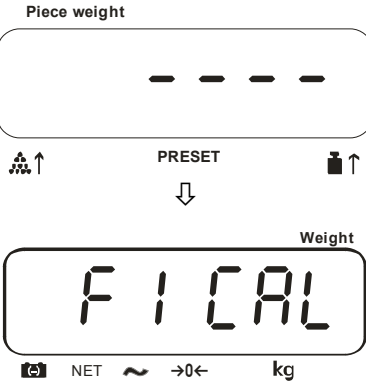

As the acceleration value due to gravity is not the same at every location on earth, each balance must be coordinated - in compliance with the underlying physical weighing principle - to the existing acceleration due to gravity at its place of location (only if the balance has not already been adjusted to the location in the factory). This adjustment process must be carried out for the first commissioning, after each change of location as well as in case of fluctuating environment temperature. To receive accurate measuring values it is also recommended to adjust the balance periodically in weighing operation.

### Procedure when adjusting:

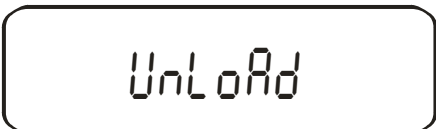
Observe stable environmental conditions. A warming up time of ca. 2 h is required for stabilization. Ensure that there are no objects on the weighing plate.

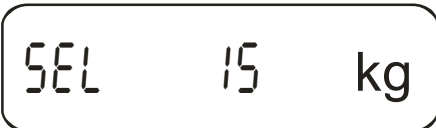
#### 7.7.1 Models CPB (Non verifiable models)



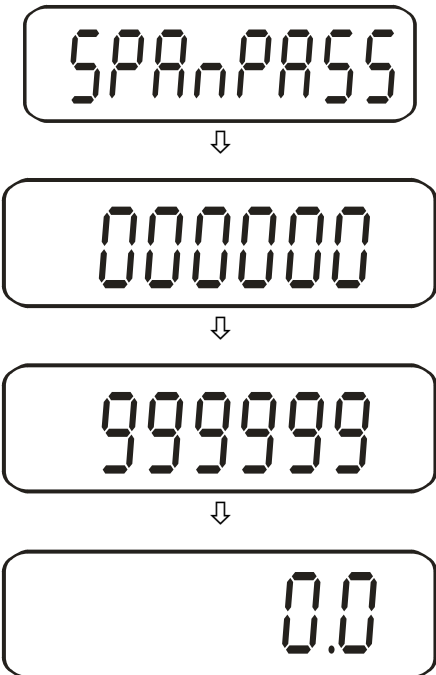









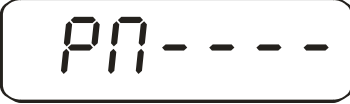

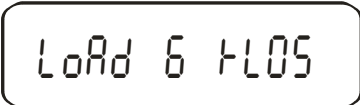

Operation	Display
<p>Switch on balance and during self-check press the TARE key</p> 	
<p>Use the number keys to enter password: Either</p> <ul style="list-style-type: none"> <li>• Default password "0000"</li> </ul> <p>or</p> <ul style="list-style-type: none"> <li>• Personal password, enter under function [F5 Pi n]</li> </ul>  <p>Confirm</p>	
 <p>Ensure that there are no objects on the weighing plate.</p>	

 <p>Zero point will be saved.</p>	 <p>The balance will suggest a weighing value for adjusting weight. However, you may enter a value of your choice via the number keys.</p>
 <p>Confirm weighing value</p>	 <p>Carefully place adjusting weight in the centre of the weighing plate</p>
<p>Wait until the stability display shows:</p>  <p>Adjustment process is started.</p> <p>The process of adjustment is completed.</p> <p>Remove adjusting weight, balance will return into weighing mode automatically. In case of an adjustment error or incorrect adjusting weight the display will show an error message (<i>SPAn / FAI Ld</i>); repeat adjustment process.</p>	

### 7.7.2 Models CPB.. M (verifiable models)

For verified balances adjustment by means of a jumper is locked. In order to carry out adjustment the two contacts of the conductor plate must be shorted with a jumper (see chapt. 7.8.1).

Observe stable environmental conditions. A warming up time of ca. 2 h is required for stabilization. Ensure that there are no objects on the weighing plate.

Operation	Display
Switch on balance	
Use the number keys to enter password „0000“:  confirmar	  
	
Ensure that there are no objects on the weighing plate. 	The required adjustment weight is displayed: 
Carefully place adjusting weight in the centre of the weighing plate  The adjustment process is started. The adjustment process has been successfully completed. Remove adjustment weight and jumper. The balance returns to weighing mode	      
In case of an adjustment error or incorrect adjustment weight an error message is shown (SPAn / FRI Ld) on the display, repeat adjustment process.	



## 7.8 Verification

### General introduction:

According to EU directive 90/384/EEC balances must be officially verified if they are used as follows (legally controlled area):

- a) For commercial transactions if the price of goods is determined by weighing
- b) For the production of medicines in pharmacies as well as for analyses in the medical and pharmaceutical laboratory
- c) For official purposes.
- d) For manufacturing final packages.

In cases of doubt, please contact your local trade in standard.

After verification the balance is sealed at the indicated positions.

**Verification of the balance is invalid without the "seal/lead seal".**

### Verification instructions

An EU type approval exists for balances described in their technical data as verifiable. If a balance is used where obligation to verify exists as described above, it must officially verified and re-verified in regular intervals.

Re-verification of a balance is carried out according to the respective national regulations. The validity for verification of balances in Germany is e.g. 2 years.

The legal regulation of the country where the balance is used must be observed!

### **Balances with obligation to verify must be taken out of operation if:**

- **The weighing result of the balance is outside the error limit.** Therefore, in regular intervals load balance with known test weight (ca. 1/3 of the max. load) and compare with displayed value.
- **The reverification deadline has been exceeded.**

## 7.8.1 Jumper and seals

### 1. Bottom of the balance

Access to conductor plate:

- Place your balance upside down
- Remove seal
- For verified balances, the jumper is on a pin
- For adjustment the jumper must be set on both pins

Position jumper for adjustment

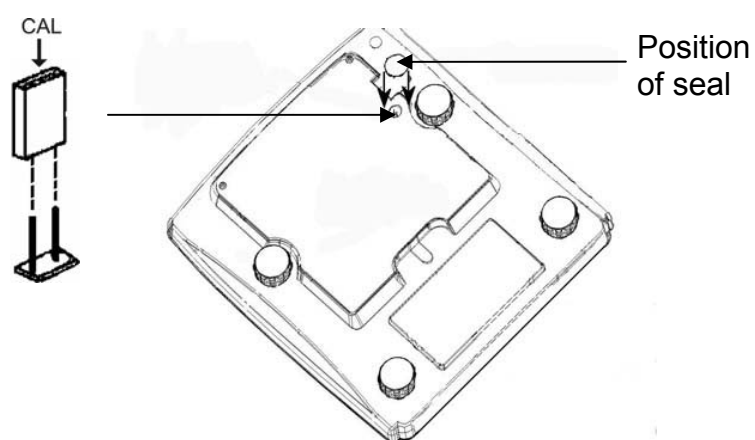

### 2. Top of the balance

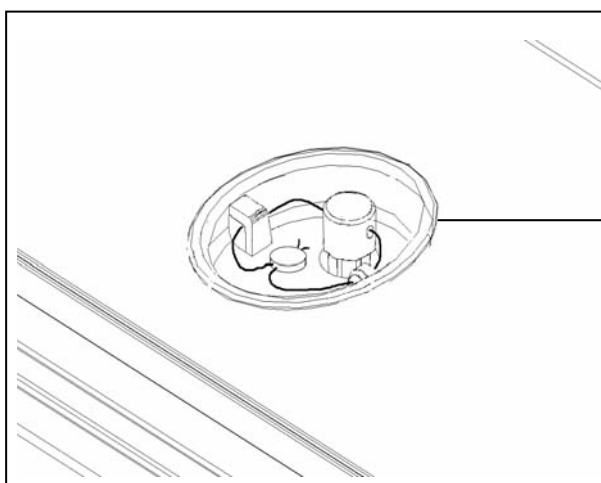

- Remove weighing plate



Sealing by seal or by lead seal

## 8 Weighing

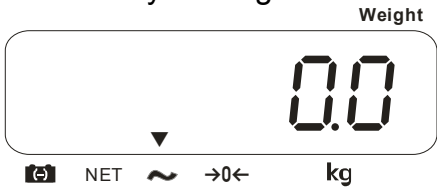
### 8.1 Switch on/off and set zero

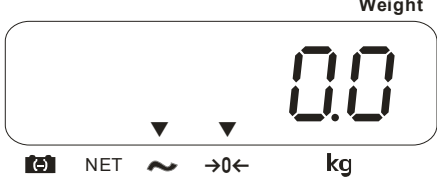
Operation	Display
<p>1. Switch on balance</p> <p>Press ON/OFF switch and hold briefly (at the bottom right side of the balance)</p> <p>The balance will carry out a self-test</p>	<p>As soon as the weight display shows "0" in all the three display windows your balance is ready to weigh.</p> 
<p>2. Zeroing</p> 	 <p>The zero display and the arrow above the „→0←“ symbol are displayed.</p>

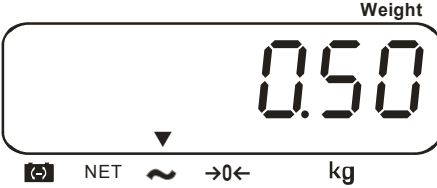

### 8.2 Simple weighing

Operation	Display
<p>Place goods onto weighing plate</p>	<p>Read weighing result</p>  <p>If weighing values are stable the arrow will be displayed above the ~ - symbol.</p>
<p>If the goods are heavier than the weighing range, the display will show "oL" (=Overload), and a whistle is sounded.</p>	

### 8.3 Weighing with taring

The dead weight of any weighing container may be tared away by pressing a button, so that the following weighings show the net weight of the goods to be weighed.

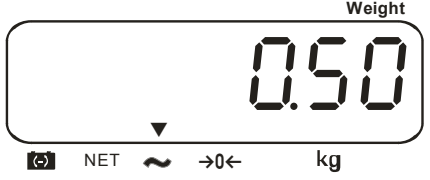
#### 8.3.1 Determination of the tare weight by weighing

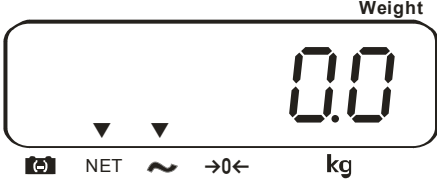
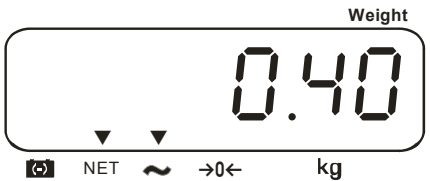
Operation	Display
Place empty tare container on the weighing plate. The total weight of the container is displayed.	
Reset display to "0": 	 <p>The weight of the container is now internally saved. Zero display and the arrow above the "NET" symbol are displayed.</p>
Place the goods to be weighed into the tare container.	Read the weight of the goods on the display. 

The taring process can be repeated any number of times, e.g. when adding several components for a mixture (adding).

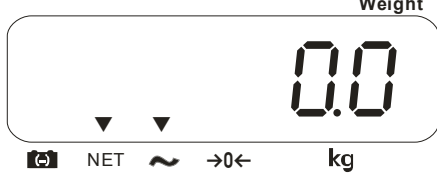
Reset display to "0": 	 <p>The total weight of the container is tared away.</p>
--	--

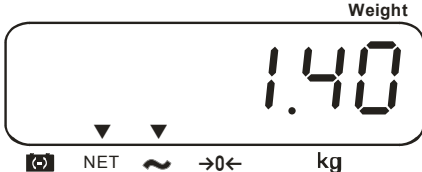

<p>Add more components into the weighing container (adding).</p>	<p>Now read off the weight of the added item to be weighed on the display.</p> 
--	---

**NOTE:**  
 The balance is able to only store one taring value at a time.  
 When the balance is unloaded the saved taring value is displayed with negative sign. Remove all items from the weighing plate in order to delete the stored tare value and subsequently press the TARE key.  
 The taring process can be repeated any number of times. The limit is reached when the whole weighing range is exhausted.

**9 Parts counting**

With parts counting you can either count parts into a container or remove parts from a container. To count a greater number of parts the average weight per part has to be determined with a small quantity (reference quantity). The larger the reference quantity, the higher the counting exactness. High reference must be selected for small parts or parts with considerably different sizes.

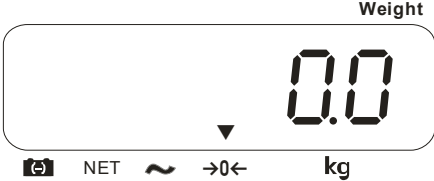
**9.1 Determination of the reference weight by weighing**

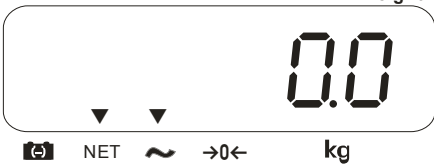
Operation	Display
<p>Set your balance at zero</p> 	
<p>Tare the weighing container:</p> 	

### Determine the reference unit:

Place a known number of parts on the balance as reference weight

If the "Weight" display is stable, enter the number of parts via number keys.

Confirm within 5 sec:



The reference weight has been determined

The reference quantity is displayed in the "Quantity" display

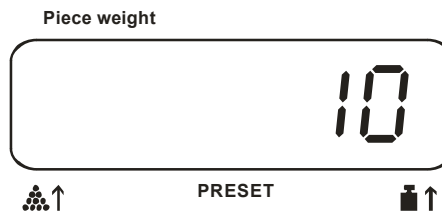
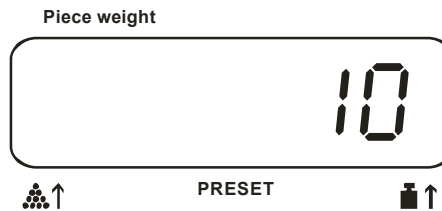
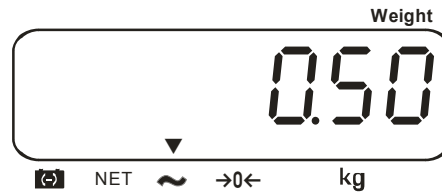

### Count the items:

Now you can place the parts to be counted onto the weighing plate. All quantity parameters of your goods to be weighed are displayed:

Weight placed on balance:

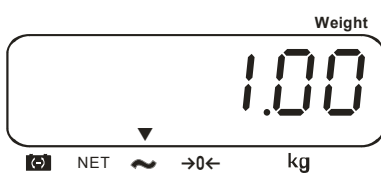



Reference weight:

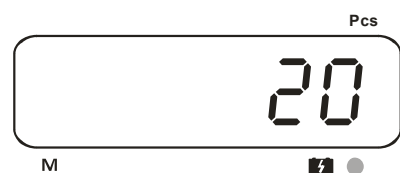

Quantity placed on balance:











### Notes:

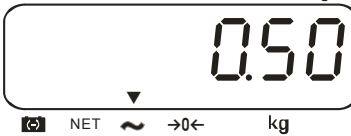

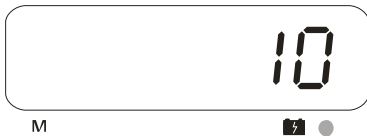
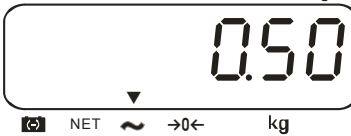
- When you add further pieces, and the quantity is less than the reference, the balance re-calculates the reference weight. Pressing the  key, there will be no re-calculation and the reference weight is locked.
- The reference weight is determined only when the weighing values are stable
- If the weighing values are below zero, the quantity display shows a negative quantity
- You can increase the accuracy of the reference weight at any time during the counting process, by entering the displayed quantity and pressing the  key.

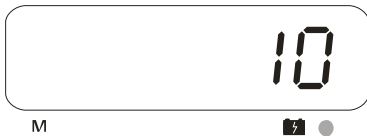
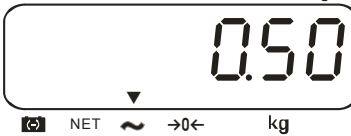
## 9.2 Numeric entering of the reference weight

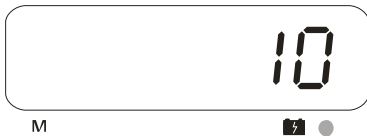
If you know the reference weight/piece you can enter this via number keys.

<p><b>Determine reference weight:</b> Enter reference weight via number keys Confirm within 5 sec:</p> 	<p>Piece weight</p> 						
<p><b>Count the items:</b> Now you can place the parts to be counted onto the weighing plate. All quantity parameters of your goods to be weighed are displayed:</p> <table><tr><td data-bbox="199 862 550 896">Weight placed on balance:</td><td data-bbox="678 862 901 896">Reference weight:</td><td data-bbox="1029 862 1364 896">Quantity placed on balance:</td></tr><tr><td data-bbox="199 918 550 1075"><p>Weight</p></td><td data-bbox="614 918 957 1075"><p>Piece weight</p></td><td data-bbox="1013 918 1380 1075"><p>Pcs</p></td></tr></table>		Weight placed on balance:	Reference weight:	Quantity placed on balance:	<p>Weight</p> 	<p>Piece weight</p> 	<p>Pcs</p> 
Weight placed on balance:	Reference weight:	Quantity placed on balance:					
<p>Weight</p> 	<p>Piece weight</p> 	<p>Pcs</p> 					



## 9.3 Automatic reference optimization

If the weight on the pan or the given quantity is too small when determining the reference, a triangle will be superimposed on [  ] or [  ] in the reference weight display.

To optimise the calculated reference weight automatically, further pieces must be added, and their quantity/weight must be less than the given reference. An acoustic signal will sound as the reference optimisation is carried out. With each reference optimisation, the reference weight is re-calculated. The reference will be more accurate because the additional pieces increase the basis for the calculation. As soon as the number of added parts exceeds the stored reference quantity, automatic reference optimisation is deactivated.



## 9.4 Target piece input

An acoustic signal is sounded as soon as the number of parts placed on the balance reaches or exceeds a pre-set limit.

<p><b>Determine limit value:</b></p> <p>Enter limit value via number keys</p> <p>Confirm within 5 sec:</p> 	 <p>The arrow above the PRESET symbol shows a saved limit value.</p>
<p><b>Delete limit value:</b></p> <p>Enter limit value "0" and confirm</p> 	

## 9.5 Manual total memory

This function allows you to execute several weighing procedure. After that, the total parts counting and the number of weighing procedures will be displayed.

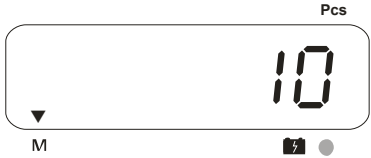
<p>Pre-requisite: Totalizing function AC mAn activated, see Chapter 10.4</p>	
<p><b>1. Weighing:</b></p> <ul style="list-style-type: none"> <li>• Select a reference weight</li> <li>• If you are using a weighing container use the TARE key for taring</li> <li>• Enter the desired quantity for the first weighing</li> <li>• Add weighing value into the memory</li> </ul>  <ul style="list-style-type: none"> <li>• Unload your balance</li> </ul>	  <p>The arrow above the M symbol indicates a saved value.</p>



## 2. Weighing:

- Enter desired quantity for the second weighing
- Add weighing value into the memory



Add and weigh more parts if needed as described above. Please note that the balance must be unloaded between the individual weighing procedures.

This process can be repeated 99 times or until the weighing range of the balance is exhausted.

### Display of you saved weighing data:



Total weight, number of weighing procedures as well as total parts counting appear 2 sec. If you connect a printer you can also print the data by pressing the PRINT key.



### To delete you saved weighing data:

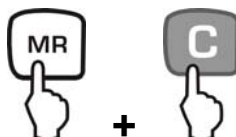

## 9.6 Automatic total memory

Execution see chapt. 9.5; the individual weighing values are automatically added into total memory without pressing the **M+** key.

Pre-requisite: Totalizing function AC Auto activated, see Chapter 10.4

## 10 Data Interface RS 232C

By using an RS 232 C interface, you can achieve bi-directional data exchange from the balance to external equipment. Data output includes weight, reference weight as well as quantity in your weighing.



### 10.1 Technical data

- ASCII code
- 8 data bits
- no parity bit
- Selectable baud rate: 600, 1200, 2400, 4800, 9600 and 19200 baud

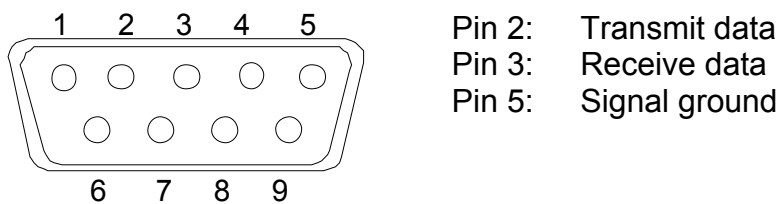
### 10.2 Pin allocation for the balance output socket (front view)





### 10.3 Data format

- Normal data output:  or 

Example:

Datum	21/02/2007
Zeit	11:32:08
Net-Gew	1.234 kg
Gew./Einh	123 /g
Stck	10 PCS

- Data output total memory:  and 

Example:

Datum	21/02/2007
Zeit	11:32:08
-----	
Gesamt	
Anzhl	5
Wt.	1.234 kg
Stck	10 PCS
-----	

- Continuous data output

ST.N.	1.234 kg
U.W.	123 /g
PCS	10 PCS

When using continuous data output, only the current weighing data will be output (without date/time).

“Grand total” **[MR]** output is not possible with continuous data output





In the menu you can set the language (German, English, French or Spanish) which is to be used for data output (see Chapter 10.4). The format for all languages is the same, but the texts differ as follows:

Description	ENGLISH	FRENCH	GERMAN	SPANISH
Net weight	Net Wt.	Pds Net	Net-Gew	Pso Net
Reference weight	Unit Wt.	Pds unit	Gew/Einh	Pso/Unid
Number of pieces	Pcs	Pcs	Stck.	Piezas
Number of weighings	No.	Nb.	Anzhl	Num.
Grand total	Total	Total	Gesamt	Total
Date	Date	Date	Datum	Fecha
Time	Time	Heure	Zeit	Hora

## 10.4 Interface parameter

The RS-232 interface uses parameters set by the user such as language, baud rate, printing mode, etc.

### Navigating in the menu:

- To access the menu, hold the  key pressed for 4 seconds
- Use the TARE key for parameter selection
- Use the  key to change the setting
- Confirm your settings using the  key, the next menu item will be displayed
- Use the  key to exit the menu, the balance returns to weighing mode.

### Menu overview:

Displays			Options	Functions
Weight	Piece weight	Pcs		
Port	on		on oder oFF	Enable or disable the RS-232 interface.
4800	bPS		600, 1200, 2400,4800, 9600 oder 19200	Set baud rate.
Print	mAn		Cont to PC, Print mAn, oder Print Auto	Select printing options for continuous out, print manually, or printing automatically
AC	mAn		AC mAn, AC Auto oder AC Off	Select the operation of the accumulation method, manually, automatically or turned off.
CoUntr	Y E	nGLiSH	EnGLiSH, FrEnCH, GErMAN oder SPANiSH	Select Language to be printed.

Scale will do the following depending on the Accumulation and Print settings:

	ACCUMULATION FUNCTIONS		
PRINT FUNCTIONS	AC Auto	AC mAn	AC Off
<b>Print Auto</b>	Accumulate and print automatically	Print automatically  Accumulate and print when <b>[M+]</b> is pressed	Print automatically, <b>[M+]</b> key has no function
<b>Print mAn</b>	Automatically Accumulate but not print,  Print only when <b>[Print]</b> key pressed	Accumulate and print when <b>[M+]</b> or <b>[Print]</b> is pressed	Print when <b>[Print]</b> key is pressed,  <b>[M+]</b> key has no function
<b>Cont to PC</b>	Print continuously and accumulate automatically when stable  <b>[Print]</b> key no function	Print continuously and accumulate when <b>[M+]</b> is pressed  <b>[Print]</b> key no function	Print continuously  <b>[M+]</b> and <b>[Print]</b> key have no function

### 10.5 Input commands format







The scale can be controlled with the following commands. The commands must be sent in upper case letters, i.e. "T" not "t". Press the Enter key of the PC after each command.

<b>T&lt;cr&gt;&lt;lf&gt;</b>	Tares the scale to display the net weight. This is the same as pressing <b>[Tare]</b> key
<b>Z&lt;cr&gt;&lt;lf&gt;</b>	Sets the zero point for all subsequent weighing. The display shows zero.
<b>P&lt;cr&gt;&lt;lf&gt;</b>	Prints the results to a PC or printer using the optional RS-232 interface. It also adds the value to the accumulation memory if the accumulation function is not set to automatic. In CBC-E, the <b>[Print]</b> key will either print the current items being counted or the results of the accumulation memory if <b>[M+]</b> is pressed first.
<b>R&lt;cr&gt;&lt;lf&gt;</b>	Recall and Print- Same as if first the <b>[MR]</b> key and then the <b>[Print]</b> key is pressed. Will display the current accumulated memory and print the total results.
<b>C&lt;cr&gt;&lt;lf&gt;</b>	Same as pressing <b>[MR]</b> first and then the <b>[C]</b> key to erase the current memory.

## 10.6 Setting the date/time

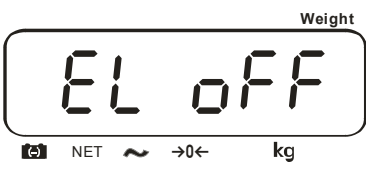

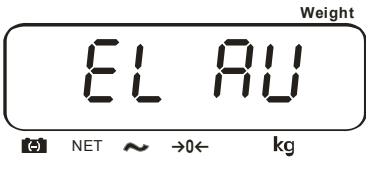

- During power up of the balance, press the **C** key and hold it pressed until the revision number of the balance is displayed. Then release the **C** key, the set date/time is displayed:  
“rtC” „08,01,07“ „16,41,35”
- Press the **C** key, the current time format “H-m-S” is displayed.
- Enter the time (24 hour format) using the number keys  
(e.g. 3:41 PM = ”154100)
- Confirm the entry with the **TARE** key, the set date is displayed
- Select the desired format with the **REF** key:  
“Y-m-d” = Year-Month-Day  
“m-d-Y” = Month-Day-Year  
“d-m-Y” = Day-Month-Year
- Confirm the selected format with the **TARE** key
- Enter the date using the number keys
- Confirm the entry with the **TARE** key. If an entry is not permitted (e.g. 34.12.07) then the error messages **Err1** (time) or **Err 2** (date) will be displayed. The balance returns to weighing mode automatically.

## 11 Display background illumination

Operation	Display
 <p>Hold down for 4 sec</p>	<p>The current setting is displayed:</p> 
<p><b>To select your setting:</b></p>  <p>Press until your desired setting is displayed</p>	<ol style="list-style-type: none"> <li>1. Background illumination off            </li> <li>2. Background illumination on            </li> <li>3. Automatic background illumination on when weighing pate is loaded            </li> </ol>
<p><b>Saving your settings:</b></p> 	<p><b>or return to weighing:</b></p> 

## 12 AUTO OFF function

For battery operation the balance has an automatic switch-off function which can be activated or deactivated in the menu. Proceed as follows:

Operation	Display
Switch on balance and press the →0← key during self test 	<p style="text-align: center;">SLEEP MODE</p>
<p style="text-align: center;"><b>To select your setting:</b></p>  Press until your desired setting is displayed	<ol style="list-style-type: none"> <li>1. Automatic switch off deactivated  <p style="text-align: center;">SLEEP MODE 0</p> </li> <li>2. Automatic switch off after 1 min  <p style="text-align: center;">SLEEP MODE 1</p> </li> <li>3. Automatic switch off after 5 min  <p style="text-align: center;">SLEEP MODE 5</p> </li> <li>4. Automatic switch off after 10 min  <p style="text-align: center;">SLEEP MODE 10</p> </li> </ol>
<p style="text-align: center;"><b>Saving your settings:</b></p> 	<p style="text-align: center;"><b>or return to weighing:</b></p> 



## **13 Service, maintenance, disposal**

### **13.1 Cleaning**

Before cleaning, please disconnect the appliance from the operating voltage.

Please do not use aggressive cleaning agents (solvents or similar agents), but a cloth dampened with mild soap suds. Ensure that no liquid penetrates into the device and wipe with a dry soft cloth.

Loose residue sample/powder can be removed carefully with a brush or manual vacuum cleaner.

**Spilled weighing goods must be removed immediately.**

### **13.2 Service, maintenance**

The appliance may only be opened by trained service technicians who are authorized by KERN.

Before opening, disconnect from power supply.

### **13.3 Disposal**

Disposal of packaging and appliance must be carried out by operator according to valid national or regional law of the location where the appliance is used.

## 14 Instant help

In case of an error in the program process, briefly turn off the balance and disconnect from power supply. The weighing process must then be restarted from the beginning.

<b>Fault</b>	<b>Possible cause</b>
<i>The displayed weight does not glow.</i>	<ul style="list-style-type: none"> <li>• <i>The balance is not switched on.</i></li> </ul>
	<ul style="list-style-type: none"> <li>• <i>The mains supply connection has been interrupted (mains cable not plugged in/faulty).</i></li> </ul>
	<ul style="list-style-type: none"> <li>• <i>Power supply interrupted.</i></li> </ul>
	<ul style="list-style-type: none"> <li>• <i>Batteries are inserted incorrectly or empty</i></li> </ul>
	<ul style="list-style-type: none"> <li>• <i>No batteries inserted.</i></li> </ul>
<i>The displayed weight is permanently changing</i>	<ul style="list-style-type: none"> <li>• <i>Draught/air movement</i></li> </ul>
	<ul style="list-style-type: none"> <li>• <i>Table/floor vibrations</i></li> </ul>
	<ul style="list-style-type: none"> <li>• <i>Weighing plate has contact with other objects.</i></li> <li>• <i>Electromagnetic fields / static charging (choose different location/switch off interfering device if possible)</i></li> </ul>
<i>The weighing value is obviously incorrect</i>	<ul style="list-style-type: none"> <li>• <i>The display of the balance is not at zero</i></li> </ul>
	<ul style="list-style-type: none"> <li>• <i>Adjustment is no longer correct.</i></li> </ul>
	<ul style="list-style-type: none"> <li>• <i>Great fluctuations in temperature.</i></li> <li>• <i>Electromagnetic fields / static charging (choose different location/switch off interfering device if possible)</i></li> </ul>

<b>Error message</b>	<b>Description</b>	<b>Possible causes</b>
<b>Err 4</b>	<i>Zeroing only in the permitted range (4% of the max. weighing range) and not for overload/underload</i>	<ul style="list-style-type: none"> <li>• <i>Object on the weighing plate</i></li> <li>• <i>Overload when zeroing</i></li> <li>• <i>Improper adjustment</i></li> <li>• <i>Damaged weighing cell</i></li> <li>• <i>Damaged electronics</i></li> </ul>
<b>Err 5</b>	<i>Keyboard error</i>	<ul style="list-style-type: none"> <li>• <i>Improper operation of the balance</i></li> </ul>
<b>Err 6</b>	<i>Value outside the A/D changer range</i>	<ul style="list-style-type: none"> <li>• <i>Weighing plate not installed</i></li> <li>• <i>Damaged weighing cell</i></li> <li>• <i>Damaged electronics</i></li> </ul>
<b>FAIL H or FAIL L</b>	<i>Adjustment error</i>	<ul style="list-style-type: none"> <li>• <i>Improper adjustment</i></li> <li>• <i>Deviation to factory adjustment &gt; 10%</i></li> </ul>
<b>Err 8</b>	<i>Adjustment error</i>	<ul style="list-style-type: none"> <li>• <i>Improper adjustment</i></li> <li>• <i>Incorrect adjusting weight</i></li> <li>• <i>Balance unstable</i></li> </ul>
<b>Err 9</b>	<i>Weighing result unstable</i>	<ul style="list-style-type: none"> <li>• <i>Draught/air movement</i></li> <li>• <i>Table/floor vibrations</i></li> </ul>

Should other error messages occur, switch balance off and then on again. If the error message remains inform manufacturer.