





# Lubricators LOE, D series



# Lubricators LOE, D series, metal design

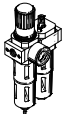

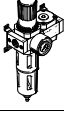
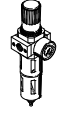
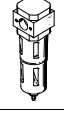
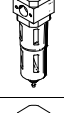
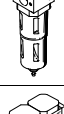
Product range overview D series service units, metal design

Type	Size	Pneumatic connection										Pressure regulation range [bar]			Grade of filtration [µm]			
		M5	M7	G1/8	G1/4	G3/8	G1/2	G3/4	G1	QS4	QS6	0.5 ...	0.5 ...	2.5 ...	0.01	1	5	40
<b>Service units</b>																		
<b>FRC/FRCS</b> 	Micro	■	■	■	-	-	-	-	-	■	■	■	-	-	-	-	■	-
	Mini	-	-	■	■	■	-	-	-	-	-	■	■	-	-	-	■	■
	Midi	-	-	-	■	■	■	■	-	-	-	■	■	-	-	-	■	■
	Maxi	-	-	-	-	-	■	■	■	-	-	■	■	-	-	-	■	■
<b>Service unit combinations</b>																		
<b>FRC-K</b> 	Micro	-	-	-	-	-	-	-	-	-	-	-	-	-	-	-	-	
	Mini	-	-	■	■	-	-	-	-	-	-	■	■	-	-	-	-	■
	Midi	-	-	-	■	■	■	-	-	-	-	■	■	-	-	-	-	■
	Maxi	-	-	-	-	-	■	■	-	-	-	■	■	-	-	-	-	■
<b>LFR-K LFRS-K</b> 	Micro	-	-	-	-	-	-	-	-	-	-	-	-	-	-	-	-	
	Mini	-	-	■	■	-	-	-	-	-	-	■	■	-	-	-	-	■
	Midi	-	-	-	■	■	■	-	-	-	-	■	■	-	-	-	-	■
	Maxi	-	-	-	-	-	■	■	-	-	-	■	■	-	-	-	-	■
<b>Individual devices</b>																		
<b>Filter regulators LFR/LFRS</b> 	Micro	■	■	■	-	-	-	-	-	■	■	■	-	-	-	-	■	-
	Mini	-	-	■	■	■	-	-	-	-	-	■	■	-	-	-	■	■
	Midi	-	-	-	■	■	■	■	-	-	-	■	■	-	-	-	■	■
	Maxi	-	-	-	-	-	■	■	■	-	-	■	■	-	-	-	■	■
<b>Filters LF</b> 	Micro	■	■	■	-	-	-	-	-	■	■	-	-	-	-	-	■	-
	Mini	-	-	■	■	■	-	-	-	-	-	-	-	-	-	-	■	■
	Midi	-	-	-	■	■	■	■	-	-	-	-	-	-	-	-	■	■
	Maxi	-	-	-	-	-	■	■	■	-	-	-	-	-	-	-	■	■
<b>Fine and micro filters LFMA/LFMB</b> 	Micro	-	-	-	-	-	-	-	-	-	-	-	-	-	-	-	-	-
	Mini	-	-	■	■	■	-	-	-	-	-	-	-	-	■	■	-	-
	Midi	-	-	-	■	■	■	■	-	-	-	-	-	-	■	■	-	-
	Maxi	-	-	-	-	-	■	■	■	-	-	-	-	-	■	■	-	-
<b>Active carbon filters LFX</b> 	Micro	-	-	-	-	-	-	-	-	-	-	-	-	-	-	-	-	-
	Mini	-	-	■	■	■	-	-	-	-	-	-	-	-	-	-	-	-
	Midi	-	-	-	■	■	■	■	-	-	-	-	-	-	-	-	-	-
	Maxi	-	-	-	-	-	■	■	■	-	-	-	-	-	-	-	-	-
<b>Filter combinations LFMBA</b> 	Micro	-	-	-	-	-	-	-	-	-	-	-	-	-	-	-	-	-
	Mini	-	-	■	■	■	-	-	-	-	-	-	-	-	■	■	-	-
	Midi	-	-	-	■	■	■	■	-	-	-	-	-	-	■	■	-	-
	Maxi	-	-	-	-	-	■	■	■	-	-	-	-	-	■	■	-	-
<b>Pressure regulators LR/LRS</b> 	Micro	■	■	■	-	-	-	-	-	■	■	■	-	-	-	-	-	-
	Mini	-	-	■	■	■	-	-	-	-	-	■	■	-	-	-	-	-
	Midi	-	-	-	■	■	■	■	-	-	-	■	■	-	-	-	-	-
	Maxi	-	-	-	-	-	■	■	■	-	-	■	■	-	-	-	-	-







# Lubricators LOE, D series, metal design

Product range overview D series service units, metal design

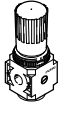
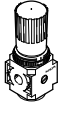
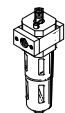
Type	Size	Bowl guard		Condensate drain			Pressure indication		Actuator lock		Supply voltage			Options			→ Page/ Internet
		Metal bowl guard	Plastic bowl	Manual rotary	Semi-automatic	Fully automatic	With pressure gauge	Without pressure gauge	Rotary knob with detent	Rotary knob with integrated lock	24 V DC	110 V AC	230 V AC	Directly actuated pressure regulator with integrated return flow function	Pilot actuated pressure regulator with integrated return flow function	Differential pressure indicator	
<b>Service units</b>																	
FRC/FRCS	Micro	-	■	■	■	-	■	■	■	-	-	-	-	-	-	-	frc
	Mini	■	-	■	-	■	■	■	■	■	-	-	-	-	-	-	
	Midi	■	-	■	-	■	■	■	■	■	-	-	-	-	-	-	
	Maxi	■	-	■	-	■	■	■	■	■	-	-	-	■	■	-	
<b>Service unit combinations</b>																	
FRC-K	Micro	-	-	-	-	-	-	-	-	-	-	-	-	-	-	-	frc
	Mini	■	-	■	-	■	■	-	■	-	■	-	-	-	-	-	
	Midi	■	-	■	-	■	■	-	■	-	■	-	-	-	-	-	
	Maxi	■	-	■	-	■	■	-	■	-	■	-	-	■	■	-	
LFR-K LFRS-K	Micro	-	-	-	-	-	-	-	-	-	-	-	-	-	-	-	lfr
	Mini	■	-	■	-	■	■	-	■	■	■	-	-	-	-	-	
	Midi	■	-	■	-	■	■	-	■	■	■	-	-	-	-	-	
	Maxi	■	-	■	-	■	■	-	■	■	■	-	-	■	■	-	
<b>Individual devices</b>																	
Filter regulators LFR/LFRS	Micro	-	■	■	■	-	■	■	■	-	-	-	-	-	-	-	lfr
	Mini	■	-	■	-	■	■	■	■	■	-	-	-	-	-	-	
	Midi	■	-	■	-	■	■	■	■	■	-	-	-	-	-	-	
	Maxi	■	-	■	-	■	■	■	■	■	-	-	-	■	■	-	
Filters LF	Micro	-	■	■	■	-	-	-	-	-	-	-	-	-	-	-	lf
	Mini	■	-	■	-	■	-	-	-	-	-	-	-	-	-	-	
	Midi	■	-	■	-	■	-	-	-	-	-	-	-	-	-	-	
	Maxi	■	-	■	-	■	-	-	-	-	-	-	-	-	-	-	
Fine and micro filters LFMA/LFMB	Micro	-	-	-	-	-	-	-	-	-	-	-	-	-	-	-	lfma, lfmb
	Mini	■	-	■	-	■	-	-	-	-	-	-	-	-	-	■	
	Midi	■	-	■	-	■	-	-	-	-	-	-	-	-	-	■	
	Maxi	■	-	■	-	■	-	-	-	-	-	-	-	-	-	■	
Active carbon filters LFX	Micro	-	-	-	-	-	-	-	-	-	-	-	-	-	-	-	lfx
	Mini	■	-	-	-	-	-	-	-	-	-	-	-	-	-	-	
	Midi	■	-	-	-	-	-	-	-	-	-	-	-	-	-	-	
	Maxi	■	-	-	-	-	-	-	-	-	-	-	-	-	-	-	
Filter combinations LFMBA	Micro	-	-	-	-	-	-	-	-	-	-	-	-	-	-	-	lfmba
	Mini	■	-	■	-	■	-	-	-	-	-	-	-	-	-	■	
	Midi	■	-	■	-	■	-	-	-	-	-	-	-	-	-	■	
	Maxi	■	-	■	-	■	-	-	-	-	-	-	-	-	-	■	
Pressure regulators LR/LRS	Micro	-	-	-	-	-	■	■	■	-	-	-	-	-	-	-	lr
	Mini	-	-	-	-	-	■	■	■	■	-	-	-	■	-	-	
	Midi	-	-	-	-	-	■	■	■	■	-	-	-	■	-	-	
	Maxi	-	-	-	-	-	■	■	■	■	-	-	-	■	■	-	

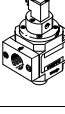
# Lubricators LOE, D series, metal design

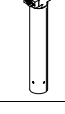
Product range overview D series service units, metal design

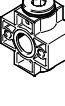
Type	Size	Pneumatic connection										Pressure regulation range [bar]		
		M5	M7	G1/8	G1/4	G3/8	G1/2	G3/4	G1	QS4	QS6	0.5 ... 7	0.5 ... 12	
<b>Individual devices</b>														
Pressure regulators <b>LRB/LRBS</b>		Micro	-											
		Mini	-	-	-	■	-	-	-	-	-	-	■	■
		Midi	-	-	-	-	■	-	-	-	-	-	■	■
		Maxi	-											
Pressure regulator combinations <b>LRB-K</b>		Micro	-											
		Mini	-	-	-	■	■	-	-	-	-	-	■	■
		Midi	-	-	-	-	■	■	-	-	-	-	■	■
		Maxi	-											
Lubricators <b>LOE</b>		Micro	■	■	■	-	-	-	-	-	■	■	-	-
		Mini	-	-	■	■	■	-	-	-	-	-	-	-
		Midi	-	-	-	■	■	■	■	-	-	-	-	-
		Maxi	-	-	-	-	-	■	■	■	-	-	-	-
On-off valves <b>HE</b>		Micro	-											
		Mini	-	-	■	■	■	-	-	-	-	-	-	-
		Midi	-	-	-	■	■	■	■	-	-	-	-	-
		Maxi	-	-	-	-	-	■	■	■	-	-	-	-
On-off valves, electrical <b>HEE</b>		Micro	-											
		Mini	-	-	■	■	■	-	-	-	-	-	-	-
		Midi	-	-	-	■	■	■	■	-	-	-	-	-
		Maxi	-	-	-	-	-	■	■	■	-	-	-	-
On-off valves, pneumatic <b>HEP</b>		Micro	-											
		Mini	-	-	■	■	■	-	-	-	-	-	-	-
		Midi	-	-	-	■	■	■	■	-	-	-	-	-
		Maxi	-	-	-	-	-	■	■	■	-	-	-	-
Soft-start valves <b>HEL</b>		Micro	-											
		Mini	-	-	■	■	■	-	-	-	-	-	-	-
		Midi	-	-	-	■	■	■	■	-	-	-	-	-
		Maxi	-	-	-	-	-	■	■	■	-	-	-	-
Membrane air dryers <b>LDM1</b>		Micro	-											
		Mini	-											
		Midi	-											
		Maxi	-	-	-	-	-	■	■	■	-	-	-	-
Branching modules <b>FRM</b>		Micro	-											
		Mini	-	-	■	■	■	-	-	-	-	-	-	-
		Midi	-	-	-	■	■	■	■	-	-	-	-	-
		Maxi	-	-	-	-	-	■	■	■	-	-	-	-
Distributor block <b>FRZ</b>		Micro	-											
		Mini	-											
		Midi	-											
		Maxi	-											

# Lubricators LOE, D series, metal design

Product range overview D series service units, metal design

Type	Size	Bowl guard		Pressure indication		Actuator lock		Supply voltage			Options		→ Page/ Internet
		Metal bowl guard	Plastic bowl	With pressure gauge	Without pressure gauge	Rotary knob with detent	Rotary knob with integrated lock	24 V DC	110 V AC	230 V AC	Non-return function	Pressure switch	
<b>Individual devices</b>													
Pressure regulators <b>LRB/LRBS</b>	Micro	-	-	-	■	■	■	-	-	-	-	-	lrb
	Mini	-	-	-	■	■	■	-	-	-	-	-	
	Midi	-	-	-	■	■	■	-	-	-	-	-	
	Maxi	-	-	-	■	■	■	-	-	-	-	-	
Pressure regulator combinations <b>LRB-K</b>	Micro	-	-	-	■	■	-	-	-	-	-	-	lrb
	Mini	-	-	-	■	■	-	-	-	-	-	-	
	Midi	-	-	-	■	■	-	-	-	-	-	-	
	Maxi	-	-	-	■	■	-	-	-	-	-	-	
Lubricators <b>LOE</b>	Micro	-	■	-	■	-	-	-	-	-	-	-	6
	Mini	■	-	-	■	-	-	-	-	-	-	-	
	Midi	■	-	-	■	-	-	-	-	-	-	-	
	Maxi	■	-	-	■	-	-	-	-	-	-	-	
On-off valves <b>HE</b>	Micro	-	-	-	■	■	-	-	-	-	-	-	he
	Mini	-	-	-	■	■	-	-	-	-	-	-	
	Midi	-	-	-	■	■	-	-	-	-	-	-	
	Maxi	-	-	-	■	■	-	-	-	-	-	-	
On-off valves, electrical <b>HEE</b>	Micro	-	-	-	■	-	-	■	■	■	-	-	hee
	Mini	-	-	-	■	-	-	■	■	■	-	-	
	Midi	-	-	-	■	-	-	■	■	■	-	-	
	Maxi	-	-	-	■	-	-	■	■	■	-	-	
On-off valves, pneumatic <b>HEP</b>	Micro	-	-	-	■	-	-	-	-	-	-	-	hep
	Mini	-	-	-	■	-	-	-	-	-	-	-	
	Midi	-	-	-	■	-	-	-	-	-	-	-	
	Maxi	-	-	-	■	-	-	-	-	-	-	-	
Soft-start valves <b>HEL</b>	Micro	-	-	-	■	-	-	-	-	-	-	-	hel
	Mini	-	-	-	■	-	-	-	-	-	-	-	
	Midi	-	-	-	■	-	-	-	-	-	-	-	
	Maxi	-	-	-	■	-	-	-	-	-	-	-	
Membrane air dryers <b>LDM1</b>	Micro	-	-	-	■	-	-	-	-	-	-	-	ldm1
	Mini	-	-	-	■	-	-	-	-	-	-	-	
	Midi	-	-	-	■	-	-	-	-	-	-	-	
	Maxi	■	-	-	■	-	-	-	-	-	-	-	
Branching modules <b>FRM</b>	Micro	-	-	-	■	-	-	-	-	-	■	■	frm
	Mini	-	-	-	■	-	-	-	-	-	■	■	
	Midi	-	-	-	■	-	-	-	-	-	■	■	
	Maxi	-	-	-	■	-	-	-	-	-	■	■	
Distributor block <b>FRZ</b>	Micro	-	-	-	■	-	-	-	-	-	-	-	frz
	Mini	-	-	-	■	-	-	-	-	-	-	-	
	Midi	-	-	-	■	-	-	-	-	-	-	-	
	Maxi	-	-	-	■	-	-	-	-	-	-	-	

# Lubricators LOE, D series, metal design

Peripherals overview

## Micro

Individual unit with connection plates,  
connection size G $\frac{1}{8}$ , QS4 or QS6

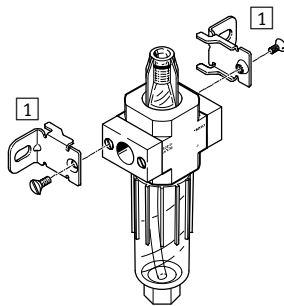

Individual unit without connection plates, for service unit combination  
connection thread M5 or M7 in housing

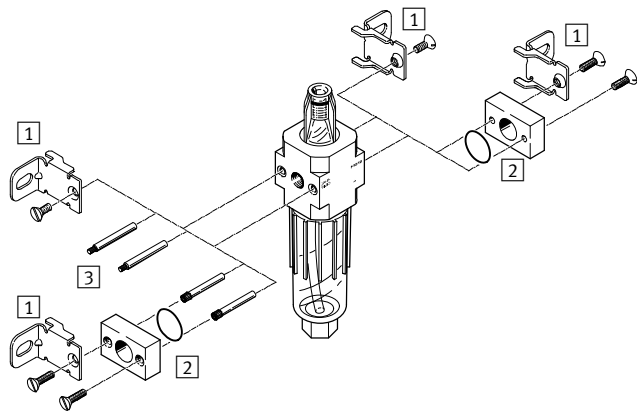

Mounting attachments and accessories					
	Individual unit		Combination		→ Page/ Internet
	with connection plates	without connection plates	with connection plates	without connection plates	
1 Mounting bracket HFOE	■	■	■	■	hfoe-d
2 Connecting plate kit PBL	-	■	-	■	pbl
3 Threaded pin FRB	-	-	■	■	frb-d

## Mini/Midi/Maxi

Individual unit with connection plates

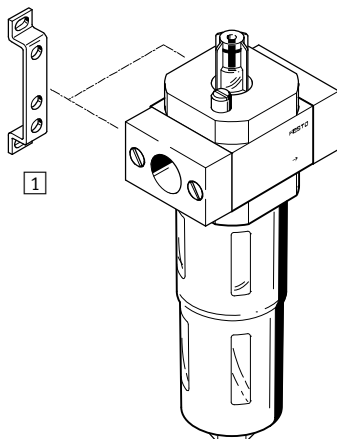

Individual unit without connection plates, for service unit combination

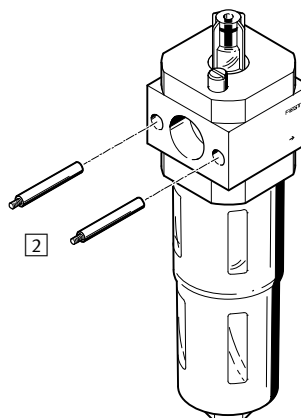

Mounting attachments and accessories					
	Individual unit		Combination		→ Page/ Internet
	with connection plates	without connection plates	with connection plates	without connection plates	
1 Mounting bracket HFOE	■	-	■	-	hfoe-d
2 Threaded pin (included in scope of delivery) FRB	-	-	■	■	frb-d

# Lubricators LOE, D series, metal design

Type codes

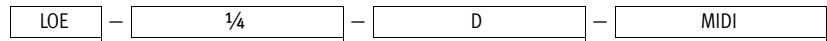

**Basic function**

LOE	Lubricator
-----	------------

**Pneumatic connection**

MINI/MIDI/MAXI

	Without connecting plates
--	---------------------------

MICRO

M5	Connecting thread M5 in housing
----	---------------------------------

M7	Connecting thread M7 in housing
----	---------------------------------

1/8	Connecting plates with connecting thread G1/8
-----	---

QS4	Connecting plates with push-in connector QS-4
-----	---

QS6	Connecting plates with push-in connector QS-6
-----	---

MINI

1/8	Connecting plates with connecting thread G1/8
-----	---

1/4	Connecting plates with connecting thread G1/4
-----	---

3/8	Connecting plates with connecting thread G3/8
-----	---

MIDI

1/4	Connecting plates with connecting thread G1/4
-----	---

3/8	Connecting plates with connecting thread G3/8
-----	---

1/2	Connecting plates with connecting thread G1/2
-----	---

3/4	Connecting plates with connecting thread G3/4
-----	---

MAXI

1/2	Connecting plates with connecting thread G1/2
-----	---

3/4	Connecting plates with connecting thread G3/4
-----	---

1	Connecting plates with connecting thread G1
---	---

**Series**

D	Series
---	--------

**Size**

MICRO	Grid dimension 25 mm (without connecting plates)
-------	--

MINI	Grid dimension 40 mm (without connecting plates)
------	--

MIDI	Grid dimension 55 mm (without connecting plates)
------	--

MAXI	Grid dimension 66 mm (without connecting plates)
------	--



# Lubricators LOE, D series, metal design

Technical data

FESTO

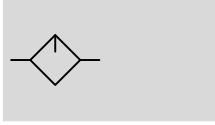
Function



-  - Flow rate  
160 ... 9,000 l/min
-  - Temperature range  
-10 ... +60 °C
-  - Operating pressure  
0 ... 16 bar



The proportional lubricator adds a precision adjustable quantity of oil to the compressed air stream. The pressure drop that occurs when air flows through a Venturi nozzle is used to convey oil from the container

to the drip cap. From here, the oil drips into the air duct directly behind the proportional valve, where it is atomised. The oil mist component is proportional to the compressed air flow rate.

- Proportional lubricator with precision oil metering
- Reduces wear on drive units subject to high loading
- High flow rate
- Quick and easy oil top-up
- Robust metal housing
- Transparent lubricator bowl with metallic bowl guard

The following oils are recommended for Festo components:  
Viscosity range to ISO 3448, ISO class VG 32  
32 mm<sup>2</sup>/s (= cSt) at 40 °C

- Festo special oil → 14
- ARAL Vitam GF 32
- BP Energol HLP 32
- Esso Nuto H 32
- Mobil DTE 24
- Shell Tellus Oil DO 32

General technical data				
Size	Micro	Mini	Midi	Maxi
Pneumatic connection 1, 2 <sup>1)</sup>	M5 <sup>2)</sup> , M7 <sup>2)</sup> , G1/8, QS-4 <sup>3)</sup> , QS-6 <sup>3)</sup>	G1/8, G1/4, G3/8, - <sup>4)</sup>	G1/4, G3/8, G1/2, G3/4, - <sup>4)</sup>	G1/2, G3/4, G1, - <sup>4)</sup>
Design	Proportional standard mist lubricator			
Type of mounting	Via accessories In-line installation			
Mounting position	Vertical ±5°			
Air purity class at the output	Compressed air according to ISO 8573-1:2010 [7:4:4] Inert gases			
Bowl guard	-		Metal bowl guard	
Minimum flow for lubricator operation [l/min]	3	3	8	10
Max. oil capacity [cm <sup>3</sup> ]	6.5	45	110	100

1) Connecting plates with connecting thread  
 2) Without connecting plates, connecting thread in housing  
 3) Connecting plates with push-in connector  
 4) Without connecting plates.  
 -  Note: This product conforms to ISO 1179-1 and to ISO 228-1



# Lubricators LOE, D series, metal design

Technical data

Standard nominal flow rate <sup>1)</sup> q <sub>nN</sub> [l/min]					
Size	Micro				
Pneumatic connection 1, 2	M5	M7	G $\frac{1}{8}$	QS-4	QS-6
LOE	200	430	410	160	330

1) Measured at p<sub>1</sub> = 6 bar and Δp = 1 bar.

Standard nominal flow rate q <sub>nN</sub> <sup>1)</sup> [l/min]										
Size	Mini			Midi				Maxi		
Pneumatic connection 1, 2	G $\frac{1}{8}$	G $\frac{1}{4}$	G $\frac{3}{8}$	G $\frac{1}{4}$	G $\frac{3}{8}$	G $\frac{1}{2}$	G $\frac{3}{4}$	G $\frac{1}{2}$	G $\frac{3}{4}$	G1
LOE	1,300	2,300	2,700	2,800	5,500	6,100	6,300	8,300	8,400	9,000

1) Measured at p<sub>1</sub> = 6 bar and Δp = 1 bar.

Operating and environmental conditions				
Size	Micro	Mini	Midi	Maxi
Operating pressure [bar]	1 ... 10	0 ... 16		
Operating medium	Compressed air in accordance with ISO 8573-1:2010 [7:4:4] Inert gases			
Note on operating/pilot medium	Operation with lubricated medium possible (in which case lubricated operation will always be required)			
Ambient temperature [°C]	-10 ... +60			
Temperature of medium [°C]	-10 ... +60			
Storage temperature [°C]	-10 ... +60			
Corrosion resistance class CRC <sup>1)</sup>	2			
Maritime classification	See certificate (pneumatic connection G $\frac{1}{8}$ ... G1) <sup>2)</sup>			

1) Corrosion resistance class CRC 2 to Festo standard FN 940070

Moderate corrosion stress. Indoor applications in which condensation may occur. External visible parts with primarily decorative requirements for the surface and which are in direct contact with the ambient atmosphere typical for industrial applications.

2) Additional information [www.festo.com/sp](http://www.festo.com/sp) → Certificates.

Weight [g]						
Size	Micro		Mini	Midi	Maxi	
	Connecting thread	Connecting plate			Connection G $\frac{1}{2}$ , G $\frac{3}{4}$	Connection G1
LOE	39	59	270	630	1,100	1,200

## Materials

Sectional view

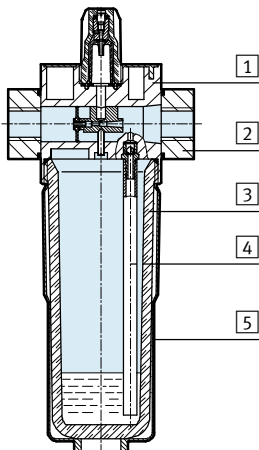

Size	Micro	Mini/Midi/Maxi
1 Housing	Die-cast aluminium	Die-cast zinc/aluminium
2 Connecting plates	Wrought aluminium alloy	Die-cast zinc/aluminium
3 Bowl	PC	
4 Tubing	PE	
5 Metal bowl guard	-	Wrought aluminium alloy
- Seals	NBR	
Note on materials	RoHS-compliant	

# Lubricators LOE, D series, metal design

Technical data



## Standard flow rate $q_n$ as a function of the differential pressure $\Delta p_{1-2}$

LOE-M5-D-MICRO

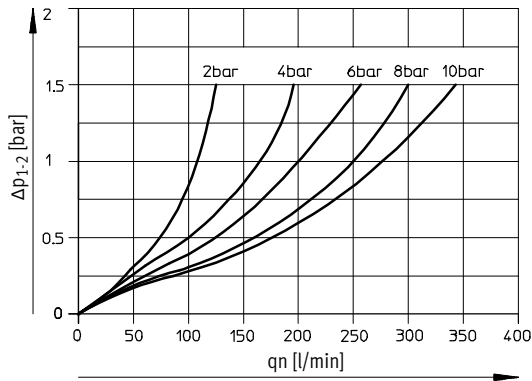

LOE-M7-D-MICRO B

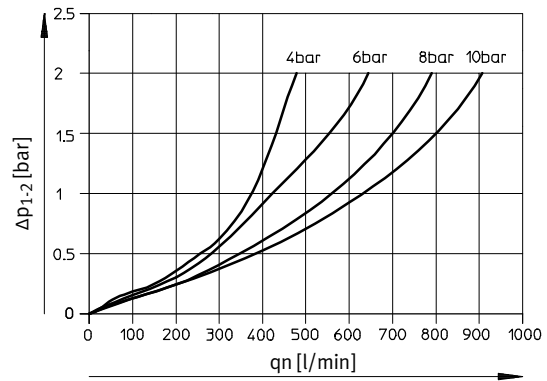

LOE-1/8-D-MICRO

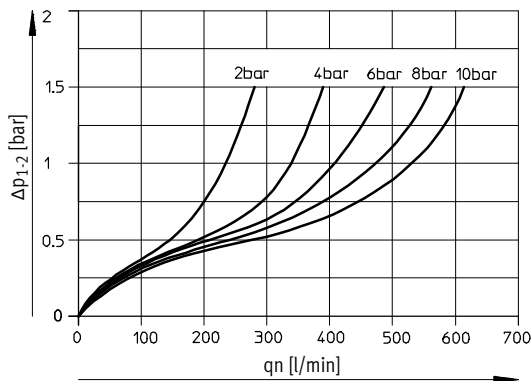

LOE-QS4-D-MICRO

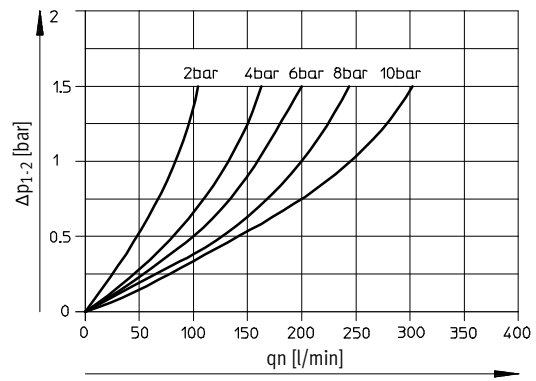

LOE-QS6-D-MICRO

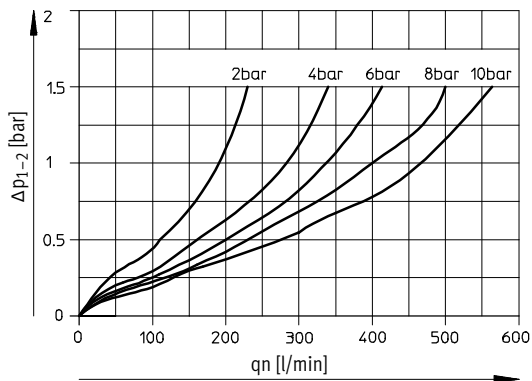

# Lubricators LOE, D series, metal design

Technical data

FESTO

## Standard flow rate $q_n$ as a function of the differential pressure $\Delta p_{1-2}$

LOE-1/4-D-MINI

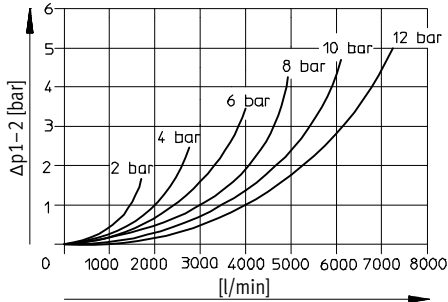

LOE-1/2-D-MIDI

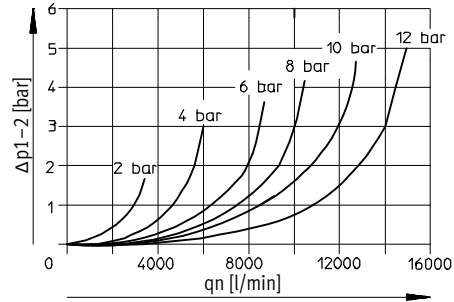

LOE-1-D-MAXI

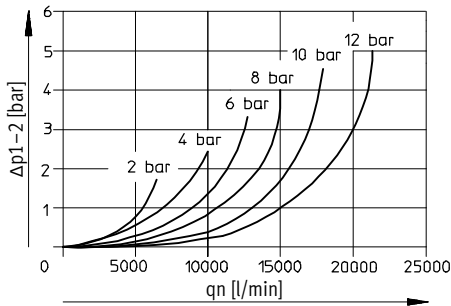

## Dimensions – Micro

Download CAD data → [www.festo.com](http://www.festo.com)

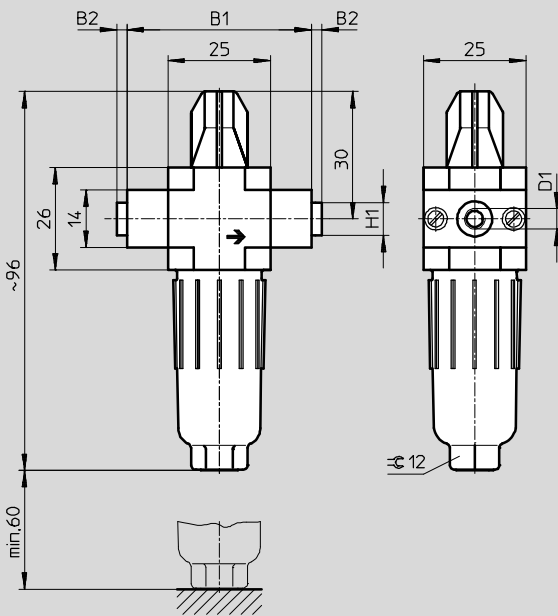

→ Flow direction

Type	B1	B2	D1	H1
LOE-M5-D-MICRO	25	-	M5	-
LOE-M7-D-MICRO B			M7	
LOE-1/8-D-MICRO	45	~2.5	G1/8	~8
LOE-QS4-D-MICRO			QS-4	
LOE-QS6-D-MICRO			QS-6	

• Note: This product conforms to ISO 1179-1 and to ISO 228-1

# Lubricators LOE, D series, metal design

Technical data

FESTO

Dimensions – Mini/Midi/Maxi Download CAD data → [www.festo.com](http://www.festo.com)

Connecting plates with connecting thread Without connecting plates

2 Metal bowl guard      4 Threaded pin (exchangeable)      5 Bleed screw for oil reservoir      → Flow direction  
3 Installation dimensions      6 Oil adjusting screw

Type	B1	B2	B3	B4	B5	D1	D2	D3	D6	H1	H2	L1	L2	L3	T1	T2	≈ 2
<b>Mini</b>																	
LOE-1/8-D-MINI	64	52	40	30	-	G1/8	-	M4	38	20	11	169	124	100	7	-	22
LOE-1/4-D-MINI						G1/4											
LOE-3/8-D-MINI	70					G3/8											
LOE-D-MINI	-	-			5.8	-	11			-	-				-	10	
<b>Midi</b>																	
LOE-1/4-D-MIDI	85	70	55	43	-	G1/4	-	M5	52	32	22	204	151	120	8	-	24
LOE-3/8-D-MIDI						G3/8											
LOE-1/2-D-MIDI						G1/2											
LOE-3/4-D-MIDI						G3/4											
LOE-D-MIDI	-	-			6.8	-	24			-	-				-	11	
<b>Maxi</b>																	
LOE-1/2-D-MAXI	96	80	66	46	-	G1/2	-	M5	65	32	22	228	170	150	8	-	24
LOE-3/4-D-MAXI						G3/4											
LOE-1-D-MAXI	116	91				G1				40							
LOE-D-MAXI	-	-			6.8	-	30			-	-				-	11	

– Note: This product conforms to ISO 1179-1 and to ISO 228-1

# Lubricators LOE, D series, metal design

Technical data

Ordering data – Micro			
Size	Connection	Part No.	Type
Without connecting plates, connecting thread in housing			
Micro	M5	<b>526309</b>	<b>LOE-M5-D-MICRO</b>
	M7	<b>534188</b>	<b>LOE-M7-D-MICRO-B</b>
Connecting plates with connecting thread			
Micro	G1/8	<b>526310</b>	<b>LOE-1/8-D-MICRO</b>
Connecting plates with push-in connector			
Micro	QS-4	<b>526313</b>	<b>LOE-QS4-D-MICRO</b>
	QS-6	<b>526314</b>	<b>LOE-QS6-D-MICRO</b>

Ordering data – Mini/Midi/Maxi			
Size	Connection	Part No.	Type
Without connecting plates			
Mini	–	<b>192575</b>	<b>LOE-D-MINI</b>
Midi	–	<b>192576</b>	<b>LOE-D-MIDI</b>
Maxi	–	<b>192577</b>	<b>LOE-D-MAXI</b>
Connecting plates with connecting thread			
Mini	G1/8	<b>159620</b>	<b>LOE-1/8-D-MINI</b>
	G1/4	<b>159621</b>	<b>LOE-1/4-D-MINI</b>
	G3/8	<b>162680</b>	<b>LOE-3/8-D-MINI</b>
Midi	G1/4	<b>186479</b>	<b>LOE-1/4-D-MIDI</b>
	G3/8	<b>159586</b>	<b>LOE-3/8-D-MIDI</b>
	G1/2	<b>159587</b>	<b>LOE-1/2-D-MIDI</b>
	G3/4	<b>162681</b>	<b>LOE-3/4-D-MIDI</b>
Maxi	G1/2	<b>186480</b>	<b>LOE-1/2-D-MAXI</b>
	G3/4	<b>159622</b>	<b>LOE-3/4-D-MAXI</b>
	G1	<b>159623</b>	<b>LOE-1-D-MAXI</b>

## Lubricators LOE, D series

Accessories

FESTO

Special oil



Ordering data		
Scope of delivery	Part No.	Type
1 litre	152811	OFSW-32