

826886-4 ✓ ACTIVE

Econoseal

TE Internal #: 826886-4

TE Internal Description: 3P ECONOSEAL "E".

[View on TE.com >](#)



Product Compliance

[For compliance documentation, visit the product page on TE.com>](#)

EU RoHS Directive 2011/65/EU	Compliant
EU ELV Directive 2000/53/EC	Compliant
China RoHS 2 Directive MIIT Order No 32, 2016	No Restricted Materials Above Threshold
EU REACH Regulation (EC) No. 1907/2006	Current ECHA Candidate List: JUL 2021 (219) Candidate List Declared Against: JAN 2021 (211) SVHC > Threshold: Not Yet Reviewed
Halogen Content	BFR/CFR/PVC Free, but Br/Cl >900 ppm in other sources.
Solder Process Capability	Not applicable for solder process capability

Product Compliance Disclaimer

This information is provided based on reasonable inquiry of our suppliers and represents our current actual knowledge based on the information they provided. This information is subject to change. The part numbers that TE has identified as EU RoHS compliant have a maximum concentration of 0.1% by weight in homogenous materials for lead, hexavalent chromium, mercury, PBB, PBDE, DBP, BBP, DEHP, DIBP, and 0.01% for cadmium, or qualify for an exemption to these limits as defined in the Annexes of Directive 2011/65/EU (RoHS2). Finished electrical and electronic equipment products will be CE marked as required by Directive 2011/65/EU. Components may not be CE marked. Additionally, the part numbers that TE has identified as EU ELV compliant have a maximum concentration of 0.1% by weight in homogenous materials for lead, hexavalent chromium, and mercury, and 0.01% for cadmium, or qualify for an exemption to these limits as defined in the Annexes of Directive 2000/53/EC (ELV). Regarding the REACH Regulation, the information TE provides on SVHC in articles for this part number is based on the latest European Chemicals Agency (ECHA) 'Guidance on requirements for substances in articles' posted at this URL: <https://echa.europa.eu/guidance-documents/guidance-on-reach>

Compatible Parts



TE Part # 539972-1
EXTRACTION TOOL

Also in the Series | Econoseal



Automotive Connector Caps & Covers
(1)

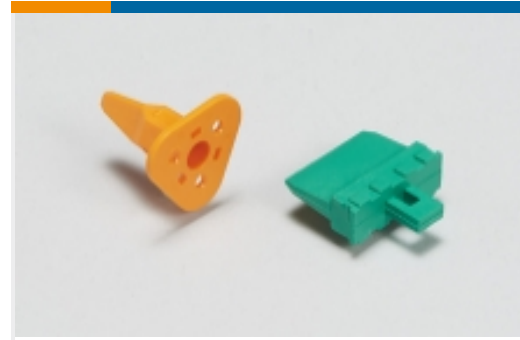

Automotive Connector Locks &
Position Assurance(25)



Automotive Housings(64)



Automotive Seals & Cavity Plugs(17)



Automotive Terminals(47)



Insertion & Extraction Tools(7)



Other Automotive Connector
Accessories(5)

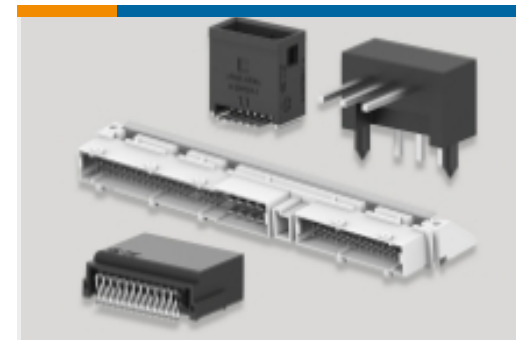

PCB Connector Headers & Receptacles
(4)



Power Cable(1)

Customers Also Bought

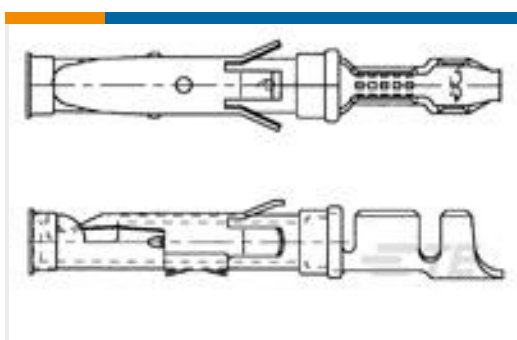

TE Part #163088-1
062 SOC.ASS. TYP3+



TE Part #CN9926-000
SBP100375WE2.5



TE Part #207439-1
9 POS SQ GRID METRIMATE-PLUG



TE Part #826885-2
3P ECONOSEAL "E"

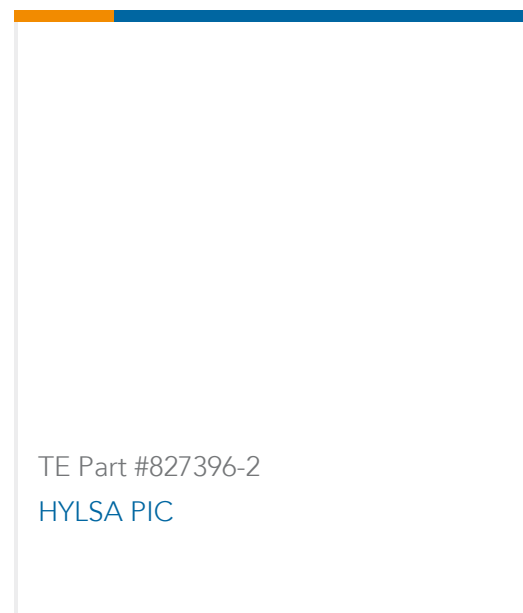
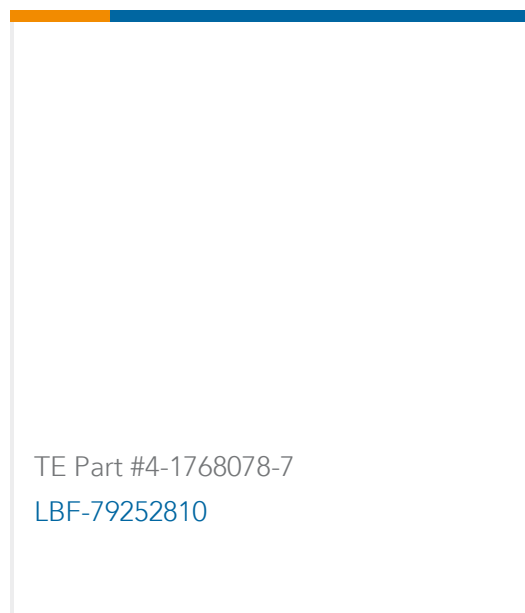
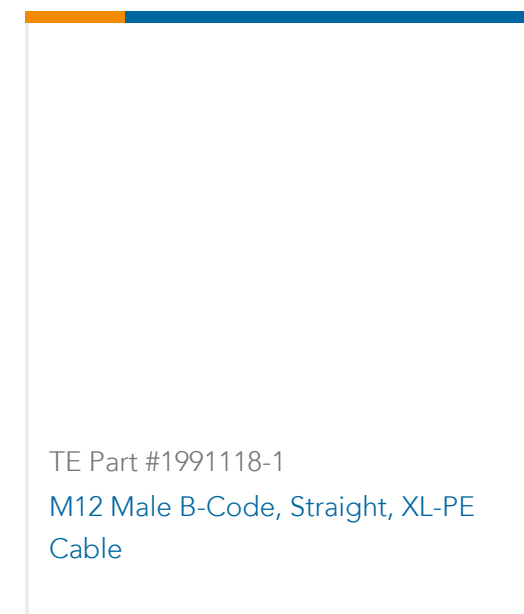
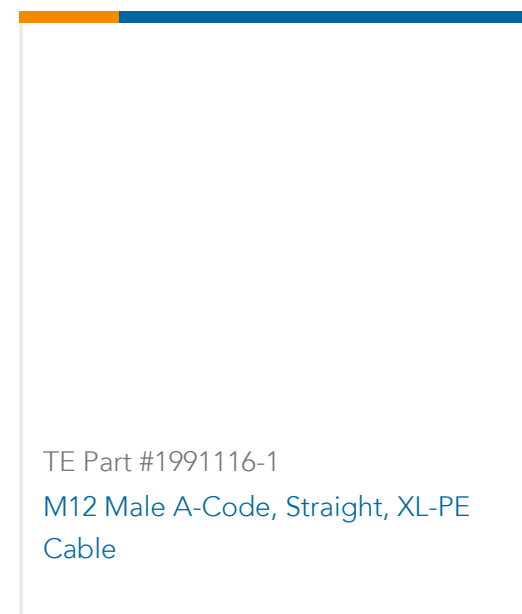
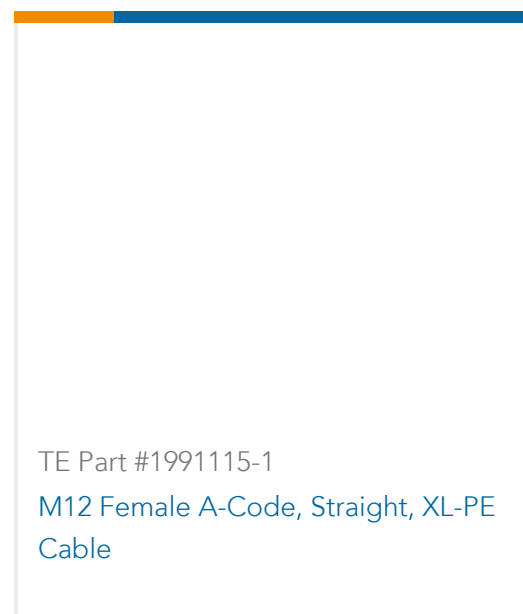

Documents

CAD Files

Customer View Model

[ENG_CVM_826886-4_H1.3d_igs.zip](#)

English

Customer View Model

[ENG_CVM_826886-4_H1.3d_stp.zip](#)

English

Customer View Model

[ENG_CVM_826886-4_H1.2d_dxf.zip](#)

English

3D PDF

English

By downloading the CAD file I accept and agree to the [Terms and Conditions](#) of use.